



# Cables & Stands Catalogue







# Cables & Stands Catalogue

## CABLES

5 STAR SERIES .....	10-20
4 STAR SERIES .....	24-37
3 STAR SERIES .....	40-56
CONNECTORS & ADAPTERS .....	60-79
BULK CABLE .....	82-96
CABLE DRUMS .....	100-107
MULTICORE SYSTEMS .....	110-121
POWER CORDS & EXTENSIONS .....	124-131
PROCAB CABLES .....	134-147

## STANDS

SPEAKER STANDS .....	150-155
MONITOR STANDS .....	156
MICROPHONE STANDS .....	160-165
LIGHTING STANDS .....	168-174
LAPTOP STANDS .....	178-179
KEYBOARD STANDS .....	182-183
GUITAR STANDS .....	186-187
MUSIC STANDS .....	190-193
MUSIC LIGHTS .....	196-202
MISCELLANEOUS .....	206-209
SPEAKER TOP HATS .....	212-213



# ABOUT THE ADAM HALL GROUP

The Adam Hall Group is a leading German manufacturing and distribution company providing event technology solutions around the globe to a diverse portfolio of business customers, including music instrument retailers and dealers, live event and rental companies, broadcast studios, AV and system integrators, private and public enterprises, and industrial flightcase manufacturers. The company offers a wide range of professional audio and lighting technology as well as stage equipment and flightcase hardware under its brands LD Systems®, Cameo®, Gravity®, Defender®, Palmer® and Adam Hall®.

Founded in 1975, Adam Hall Group has developed into a collection of modern, innovative event technology companies. This includes an 8,000 square metre warehouse and logistics centre at the corporate headquarters near Frankfurt am Main, Germany.

## ADAM HALL BRANDS:



## DISTRIBUTION BRANDS:







**SOUND**  
TECHNOLOGY

**LIGHT**  
TECHNOLOGY

**STAGE**  
EQUIPMENT

**HARDWARE**  
FOR FLIGHTCASES



## EVENT TECHNOLOGY – IT'S A PEOPLE BUSINESS

Whether you are a music instrument retailer, live event & rental company, broadcast studio, system integrator, installer, public or private enterprise, or an industrial flightcase manufacturer, we are excited to show you the latest in event technology, award-winning innovation, top quality brands, and our superior commitment to service and satisfaction.

**Experience Event Technology – and enjoy the show!**

Markus Jahnel

David Kirby

Alexander Pietschmann





PL  
14

PL  
15

PL  
16

PL  
17

# CABLES & STANDS FROM ADAM HALL

With a huge selection of ready-made cable assemblies, bulk cable and connectors plus a large variety of stands and accessories we cover the needs of musicians, DJs, technicians and contractors alike.

Built for reliability and longevity, the products in this catalogue provide perfect solutions and maximum functionality in demanding stage, studio and installation applications.

Strict quality control is a must at Adam Hall to ensure our products meet the high standards you expect because your job depends on flawless performance. We are confident you'll find the right cable or stand in these pages

## READY TO ORDER?

Please feel free to give us a call. On the back of this catalogue you will find contact details for the various sales teams around the globe. Your respective sales representative is available Mon. – Fri. and is ready to help you. Further details can be found in the 'Contact' section of our website.

[www.adamhall.com](http://www.adamhall.com)





# 5STAR

SERIES ★★★★★

SUPERIOR  
**QUALITY CABLES**

Our Superior cable series with first class Neutrik® connectors to meet the highest standards.



**CONNECTORS  
BY NEUTRIK®**  
innovative **solutions**  
superior **quality**



MADE IN EU

# INSTRUMENT CABLES



High-definition instrument cable with gold plated NEUTRIK® silentPLUG to avoid pops and squeals when changing the guitar under load. The instrument cable in the 5-Star series - for the pros! Extremely durable due to the special PVC jacket and multilayer insulation but highly flexible with a diameter of 5.9 mm only. All 5-Star cables are manufactured in Europe using NEUTRIK® plugs exclusively.

## FEATURES

- HD instrument cable with gold plated NEUTRIK® silentPLUG
- Extremely durable due to special PVC jacket and multilayer insulation
- High Flexibility

## SPECIFICATIONS

Product type:	Instrument cable
Colour:	black
Overall diameter:	6.0 mm +/- 0.2 mm
Jacket material:	PVC
AWG:	24
cross section:	0.22 mm <sup>2</sup>
Insulation:	PE 1.8 mm
Composition of conductor:	28 x 0.10 mm, bare copper, OFC
Number of inner conductors:	1
Shielding:	copper spiral shielding with 48 x 0.10 mm + semiconductor

Conductor resistance:	90 Ω/km
Capacitance Cond./Shield:	85 pF/m
Insulation Resistance:	1 GΩ
Working Temperature:	-20° to +70°

## K5IPSP INSTRUMENT CABLE

NEUTRIK SILENTPLUG 6.3 MM JACK MONO TO 6.3 MM JACK MONO

Item No.	Length	CONNECTORS:
K5IPP0300SP	3.0 m	▪ NP2X-AU-SILENT
K5IPP0600SP	6.0 m	▪ NP2X-B
K5IPP0900SP	9.0 m	



## K5IRPSP INSTRUMENT CABLE

NEUTRIK SILENTPLUG 6.3 MM ANGLED JACK MONO TO 6.3 MM JACK MONO

Item No.	Length	CONNECTORS:
K5IRP0300SP	3.0 m	▪ NP2RX-AU-SILENT
K5IRP0600SP	6.0 m	▪ NP2X-B
K5IRP0900SP	9.0 m	



# INSTRUMENT CABLES



The instrument cable in the 5-Star series - for the pros! Extremely durable thanks to a special PVC jacket and multilayer insulation, but still highly flexible with a diameter of just 5.9 mm. All 5-Star cables are manufactured in Europe exclusively using NEUTRIK® plugs.

## FEATURES

- Extremely durable due to special PVC jacket and multilayer insulation
- High Flexibility

## SPECIFICATIONS

Product type:	Instrument cable
Colour:	black
Overall diameter:	6.0 mm +/- 0.2 mm
Jacket material:	PVC
AWG:	24
cross section:	0.22 mm <sup>2</sup>
Insulation:	PE 1.8 mm
Composition of conductor:	28 x 0.10 mm, bare copper, OFC

Number of inner conductors:	1
Shielding:	copper spiral shielding with 48 x 0.10 mm + semiconductor
Conductor resistance:	90 Ω/km
Capacitance Cond./Shield.:	85 pF/m
Insulation Resistance:	1 GΩ
Working Temperature:	-20° to +70°

## K5IPP INSTRUMENT CABLE

NEUTRIK 6.3 MM JACK MONO TO 6.3 MM JACK MONO

Item No.	Length	CONNECTORS:
K5IPP0300	3.0 m	▪ NP2X-BAG
K5IPP0450	4.5 m	
K5IPP0600	6.0 m	
K5IPP0900	9.0 m	



## K5IRP INSTRUMENT CABLE

INSTRUMENT CABLE NEUTRIK 6.3 MM JACK MONO TO 6.3 MM ANGLED JACK MONO

Item No.	Length	CONNECTORS:
K5IRP0300	3.0 m	▪ NP2RX-BAG
K5IRP0450	4.5 m	▪ NP2X-BAG
K5IRP0600	6.0 m	
K5IRP0900	9.0 m	



## K5IRR INSTRUMENT CABLE

NEUTRIK 6.3 MM ANGLED JACK MONO TO 6.3 MM ANGLED JACK MONO

Item No.	Length	CONNECTORS:
K5IRR0015	0.15 m	▪ NP2RX-BAG
K5IRR0030	0.3 m	▪ NP2RX-BAG





# MICROPHONE CABLES

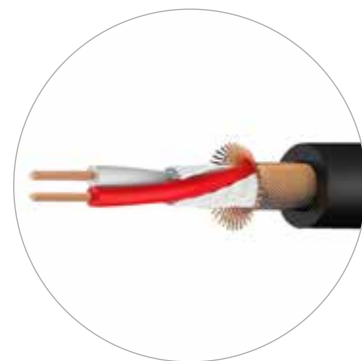

Professional, balanced microphone cable. Highly flexible and yet extremely rugged; the multilayer shielding ensure optimal insulation against electrical interference onstage. Equipped with NEUTRIK® XLR plugs on both ends.

## FEATURES

- High flexible Microphone cable with genuine NeutrX XLR connectors
- Very good shielding and fine stranded wire for superb transmission quality

## SPECIFICATIONS

Product type:	Microphone cable
Colour:	black
Overall diameter:	6.5 mm +/- 0.2 mm
Jacket material:	PVC
AWG:	24
cross section:	0.22 mm <sup>2</sup>
Insulation:	PE 1.4 mm
Composition of conductor:	28 x 0,1mm, bare cooper, OFC
Number of inner conductors:	2
Shielding:	cooper spiral shielding with 80 x 0.10 mm

Conductor resistance:	87 Ω/km
Capacitance Cond./Cond.:	68 pF/m
Capacitance Cond./Shield.:	130 pF/m
Insulation Resistance:	> 1 GΩ
Working Temperature:	-20° to +70°
Surge Impedance:	100 ohm

## K5MMF MICROPHONE CABLE

MICROPHONE CABLE NEUTRIK XLR FEMALE TO XLR MALE

Item No.	Length	CONNECTORS:
K5MMF0100	1.0 m	▪ NC3FXX
K5MMF0150	1.5 m	▪ NC3MXX
K5MMF0300	3.0 m	
K5MMF0500	5.0 m	
K5MMF0750	7.5 m	
K5MMF1000	10.0 m	
K5MMF1500	15.0 m	
K5MMF2000	20.0 m	



## K5MFP MICROPHONE CABLE

NEUTRIK XLR FEMALE TO 6.3 MM JACK MONO

Item No.	Length	CONNECTORS:
K5MFP0150	1.5 m	▪ NC3FXX
K5MFP0300	3.0 m	▪ NP2X
K5MFP0500	5.0 m	
K5MFP1000	10.0 m	



# MICROPHONE CABLES



Unbalanced instrument cable for uncompromising road use. Like all cables in the 5-Star series, it is manufactured using high-quality NEUTRIK® components and highly flexible cable. Practical for live use; the ideal choice for transmitting line signals to consoles.

## FEATURES

- High flexible Microphone cable with genuine Neutrk XLR connectors
- Very good shielding and fine stranded wire for superb transmission quality

## SPECIFICATIONS

Product type:	Microphone cable
Colour:	black
Overall diameter:	6,5 mm +/- 0,2 mm
Jacket material:	PVC
AWG:	24
cross section:	0,22 mm <sup>2</sup>
Insulation:	PE 1,4 mm
Composition of conductor:	28 x 0,1mm, bare cooper, OFC
Number of inner conductors:	2
Shielding:	cooper spiral shielding with 80 x 0,10 mm

Conductor resistance:	87 Ω/km
Capacitance Cond./Cond.:	68 pF/m
Capacitance Cond./Shield.:	130 pF/m
Insulation Resistance:	> 1 GΩ
Working Temperature:	-20° to +70°
Surge Impedance:	100 ohm

## K5MYF MICROPHONE CABLE

NEUTRIK XLR FEMALE TO 3.5 MM JACK STEREO

Item No.	Length	CONNECTORS:
K5MYF0150	1.5 m	▪ NC3FXX
K5MYF0300	3.0 m	▪ NP2X



## K5MMP MICROPHONE CABLE

MICROPHONE CABLE NEUTRIK XLR MALE TO 6.3 MM JACK MONO

Item No.	Length	CONNECTORS:
K5MMP0150	1.5 m	▪ NC3MXX
K5MMP0300	3.0 m	▪ NP2X
K5MMP0500	5.0 m	
K5MMP1000	10.0 m	



## BALANCED AUDIO CABLES

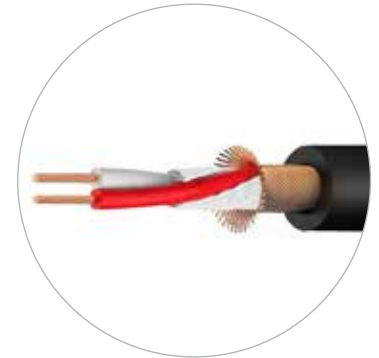

Balanced cable with a male XLR plug and a 6.3 mm stereo TRS plug, developed entirely by NEUTRIK® and manufactured in Europe. Like all cables in the 5-Star series, it is manufactured using only 5.9 mm thick and yet extremely durable and highly flexible cable with outstanding audio characteristics.

### FEATURES

- High flexible Microphone cable with genuine Neutrak XLR connectors
- Very good shielding and fine stranded wire for superb transmission quality

### SPECIFICATIONS

Product type:	Microphone cable
Colour:	black
Overall diameter:	6.5 mm +/- 0.2 mm
Jacket material:	PVC
AWG:	24
cross section:	0.22 mm <sup>2</sup>
Insulation:	PE 1.4 mm
Composition of conductor:	28 x 0,1mm, bare cooper, OFC

Number of inner conductors:	2
Shielding:	cooper spiral shielding with 80 x 0,10 mm
Conductor resistance:	87 Ω/km
Capacitance Cond./Cond.:	68 pF/m
Capacitance Cond./Shield.:	130 pF/m
Insulation Resistance:	> 1 GΩ
Working Temperature:	-20° to +70°
Surge Impedance:	100 ohm

### K5BMV BALANCED AUDIO CABLE NEUTRIK XLR MALE TO 6.3 MM JACK STEREO

Item No.	Length	Item No.	Length
K5BMV0050	0.5 m	K5BMV0300	3.0 m
K5BMV0100	1.0 m	K5BMV0500	5.0 m
K5BMV0150	1.5 m	K5BMV1000	10.0 m

#### CONNECTORS:

- NC3MXX
- NP3X



### K5BFV BALANCED AUDIO CABLE XLR FEMALE TO 6.3 MM JACK STEREO

Item No.	Length	Item No.	Length
K5BFV0050	0.5 m	K5BFV0300	3.0 m
K5BFV0100	1.0 m	K5BFV0500	5.0 m
K5BFV0150	1.5 m	K5BFV1000	10.0 m

#### CONNECTORS:

- NC3FXX
- NP3X



### K5BVV BALANCED AUDIO CABLE PATCH CABLE NEUTRIK 6.3 MM JACK STEREO TO 6.3 MM JACK STEREO

Item No.	Length	Item No.	Length
K5BVV0050	0.5 m	K5BVV0300	3.0 m
K5BVV0100	1.0 m	K5BVV0500	5.0 m
K5BVV0150	1.5 m	K5BVV1000	10.0 m

#### CONNECTORS:

- NP3X



# DMX - AES/EBU CABLES

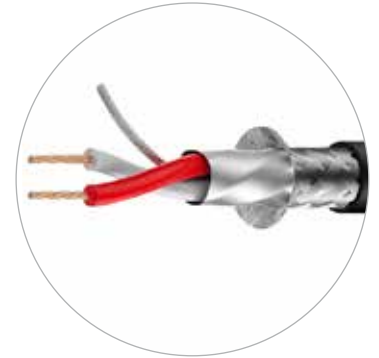

The DMX Cable with X-HD Series XLR cable connector for outdoor use. Dust and water protected according to IP 65 with Gold contacts.

## FEATURES

- Flexible AES/EBU and DMX compliant cable
- High Quality signal transmission due to large conductor cross section and OFC strands

## SPECIFICATIONS

Product type	DMX Cable
Type	DMX AES/EBU Cable
Colour	black
Overall diameter	6,0 mm +/-0,2 mm
Conductor cross-section	2 x 0.34 mm <sup>2</sup>
AWG (American Wire Gauge)	22
Conductor material	copper
Conductor construction	7 x 0.25 mm
Screen material	tinned copper braid
Line surge impedance	<56 Ohm(s)

Impedance	110 Ohm(s)
Capacitance	<42 pF/m
Temperature range	-20
Jacket material	PVC
Manufacturer of connector 1	Neutrik
Dimensions 2 (L x Ø)	69 x 19 mm

## K5DIJ DMX CABLE

5-PIN-HD- NEUTRIK XLR MALE TO XLR FEMALE

Item No.	Length
K5DIJ0150	1.5 m
K5DIJ0300	3 m
K5DIJ0500	5 m
K5DIJ1000	10 m

### CONNECTORS:

- NC3FX-HD
- NC3MX-HD



# DMX - AES/EBU CABLES

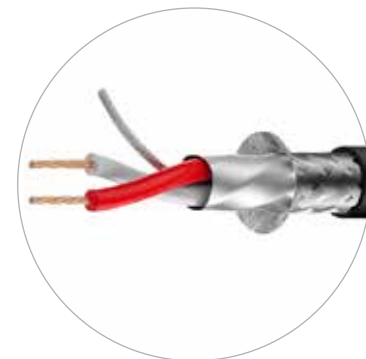

Highly flexible, rugged, and equipped with brand name connectors by NEUTRIK® – just like the audio cables in the 5-Star series, these cables also offer optimum performance. The cable material used complies with the AES/EBU standards for data communications.

## FEATURES

- Flexible AES/EBU and DMX compliant cable
- High Quality signal transmission due to large conductor cross section and OFC strands

## SPECIFICATIONS

Type:	DMX AES/EBU Cable
Color:	black
Overall diameter:	6.4 mm +/- 0.1 mm
Conductor area:	2 x 0.34 mm <sup>2</sup>
AWG (American Wire Gauge):	22
Conductor material:	copper wire screen
Composition of conductor:	19 x 0.15 mm
Screen material:	bare copper, OFC

Screen:	spiral wound
Conductor resistance:	53 Ohm / km
Capacity:	< 63 pF/m
Overall jacket material:	PVC

## DMX - AES/EBU CABLES

NEUTRIK 110 OHM DIGITAL AUDIO  
XLR MALE TO XLR FEMALE 3-PIN

Item No.	Length	Item No.	Length
K5DMF0150	1.5 m	K5DMF2000	20.0 m
K5DMF0300	3.0 m	K5DMF3000	30.0 m
K5DMF0500	5.0 m		
K5DMF1000	10.0 m		
K5DMF1500	15.0 m		

### CONNECTORS:

- NC3FXX
- NC3MXX



## K5DGH DMX - AES/EBU CABLES

NEUTRIK 110 OHM DIGITAL AUDIO XLR  
MALE TO XLR FEMALE 5-PIN

Item No.	Length	CONNECTORS:
K5DGH0150	1.5 m	▪ NC5FXX
K5DGH0300	3.0 m	▪ NC5MXX
K5DGH0500	5.0 m	
K5DGH1000	10.0 m	
K5DGH2000	20.0 m	
K5DGH3000	30.0 m	



# SPEAKER CABLES



Highly flexible speaker cable with a rugged PVC jacket, equipped with NEUTRIK® TRS plugs. Available in two lengths as a patch cable or connection cable.

## FEATURES

- Very durable loudspeaker cable due to the use of special coating
- flexible and easy to roll

## SPECIFICATIONS

Product type:	Speaker cable
Colour:	black
Overall diameter:	7.0 mm +/- 0.2 mm
Jacket material:	PVC
AWG:	16
cross section:	1.5 mm <sup>2</sup>
Composition of conductor:	48 x 0.20 mm, Copper bare, OFC
Number of inner conductors:	2

conductor PVC insulation diameter	2.7 mm
Conductor resistance:	13Ω / km
Working Temperature:	-20° to +70°

### K5S215PP SPEAKER CABLE

2 X 1.5 MM<sup>2</sup> NEUTRIK 6.3 MM JACK  
MONO TO 6.3 MM JACK MONO

Item No.	Length	CONNECTORS:
K5S215PP0150	1.5 m	▪ NP2X
K5S215PP0300	3.0 m	▪ NP2X



### K5S215SS SPEAKER CABLE

2 X 1.5 MM<sup>2</sup> NEUTRIK SPEAKON 2-POLE  
TO SPEAKON 2-POLE 0.5 M

Item No.	Length	CONNECTORS:
K5S215SS0050	0.5 m	▪ NL2FX
K5S215SS0100	1 m	▪ NL2FX
K5S215SS0200	2 m	
K5S215SS0300	3 m	
K5S215SS0500	5 m	
K5S215SS1000	10 m	



## SPEAKER CABLES



Highly flexible speaker cable with the proven KLS225S cable (2 x 2.5 mm<sup>2</sup>) and NEUTRIK® Speakon NL 2 FX plugs for optimal contact. Useable without problems even at high output levels thanks to the enlarged cable cross-section.

### FEATURES

- Very durable loudspeaker cable due to the use of special coating
- flexible and easy to roll

### SPECIFICATIONS

Product type:	Speaker cable
Colour:	black
Overall diameter:	8.0 mm +/- 0.2 mm
Jacket material:	PVC
AWG:	14
cross section:	2.5 mm <sup>2</sup>

Composition of conductor:	80 x 0.20 mm, Copper bare, OFC
Number of inner conductors:	2
conductor PVC insulation diameter	3.1 mm
Conductor resistance:	7.8 Ω / km
Working Temperature:	-20° to +70°

### K5S225SS SPEAKER CABLE

2 X 2.5 MM<sup>2</sup> NEUTRIK SPEAKON 2-POLE TO SPEAKON 2-POLE

Item No.	Length	Item No.	Length
K5S225SS0100	1.0 m	K5S225SS0500	5.0 m
K5S225SS0200	2.0 m	K5S225SS1000	10.0 m
K5S225SS0300	3.0 m	K5S225SS1500	15.0 m

#### CONNECTORS:

- NL2FX
- NL2FX



### K5S225PS SPEAKER CABLE

2 X 2.5 MM<sup>2</sup> NEUTRIK SPEAKON 2-POLE TO 6.3 MM JACK MONO

Item No.	Length	CONNECTORS:
K5S225PS0150	1.5 m	<ul style="list-style-type: none"> <li>▪ NL2FX</li> <li>▪ NP2X</li> </ul>



### K5S225PX SPEAKER CABLE

2 X 2.5 MM<sup>2</sup> NEUTRIK SPEAKON 4-POLE TO 6.3 MM JACK MONO

Item No.	Length	CONNECTORS:
K5S225PX0030	0.3 m	<ul style="list-style-type: none"> <li>▪ NLT4MX</li> <li>▪ NP2X</li> </ul>





# SPEAKER CABLES



Highly flexible speaker cable for high-powered amps. Uses the proven KLS240S cable with a conductor cross-section of 2 x 4 mm<sup>2</sup> as well as NEUTRIK® Speakon NL 4 FC plugs for optimal contact characteristics.

## FEATURES

- Very durable loudspeaker cable due to the use of special coating
- flexible and easy to roll

## SPECIFICATIONS

Product type:	Speaker cable
Colour:	black
Overall diameter:	11.0 mm +/- 0.2 mm
Jacket material:	PVC
AWG:	12
cross section:	4 mm <sup>2</sup>
Composition of conductor:	80 x 0.25 mm, bare cooper, OFC
Number of inner conductors:	2

conductor PVC insulation diameter	4.0 mm
Conductor resistance:	4.5 Ω / km
Working Temperature:	-20° to +70°

## K5S240NN SPEAKER CABLE

2 X 4 MM<sup>2</sup> NEUTRIK SPEAKON 4-POLE TO SPEAKON 4-POLE

Item No.	Length	CONNECTORS:
K5S240NN0200	2.0 m	▪ NL4FX
K5S240NN0300	3.0 m	▪ NL4FX
K5S240NN1000	10.0 m	
K5S240NN1500	15.0 m	
K5S240NN2000	20.0 m	



# SPEAKER CABLES



Four-pin variant with a conductor cross-section of 4 x 2.5 mm<sup>2</sup> and thus perfect for use in active two-way systems. Of course, these cables, too, are made using highly flexible and rugged PVC cable and NEUTRIK® NL 4 FC plugs.

## FEATURES

- Very durable loudspeaker cable due to the use of special coating
- flexible and easy to roll

## SPECIFICATIONS

Product type:	Speaker cable
Colour:	black
Overall diameter:	11.0 mm +/- 0.2 mm
Jacket material:	PVC
AWG:	13
cross section:	2.5 mm <sup>2</sup>
Composition of conductor:	80 x 0.20 mm, bare cooper, OFC
Number of inner conductors:	4

conductor PVC insulation diameter	3.1 mm
Working Temperature:	-20° to +70°

## K5S425NN SPEAKER CABLE

4 X 2.5 MM<sup>2</sup> NEUTRIK SPEAKON 4-POLE TO SPEAKON 4-POLE

Item No.	Length	CONNECTORS:
K5S425NN0040	0.4 m	▪ NL4FX
K5S425NN0300	3.0 m	▪ NL4FX
K5S425NN1000	10.0 m	
K5S425NN1500	15.0 m	
K5S425NN2000	20.0 m	
K5S225SS1500	15.0 m	









# 4STAR

SERIES ★★★★★

PREMIUM  
**QUALITY CABLES**

Our Premium cable series with original REAN® , high reliable Adam Hall or special Yongsheng by Neutrik connectors for everyday professional applications.

## INSTRUMENT CABLES

The instrument cable with the perfect price-performance ratio. Manufactured of highly flexible and rugged, double-shielded cable material with REAN © plugs. Practical for live use, making these cables the ideal choice for all patches and connections. Equipped with straight, unbalanced plugs.



### FEATURES

- Fine stranded wire for high-quality signal transmission with 100% Protection due to double shielding
- Robust and durable REAN instruments plugs

### SPECIFICATIONS

Product type:	Instrument cables
Colour:	black
Overall diameter:	6.1 mm +/- 0.2 mm
Jacket material:	PVC
AWG:	24AWG
cross section:	0.22 mm <sup>2</sup>
Insulation:	PE 1.5mm

Composition of conductor:	7 x 0,20mm, bare cooper, OFC
Number of inner conductors:	1
Shielding:	cooper spiral shielding + semiconductor
Conductor resistance:	80 Ω/km
Capacitance Cond./Shield.:	130 pF/m
Working Temperature:	-20° to +70°

### K4IPP INSTRUMENT CABLE

REAN 6.3 MM JACK MONO TO 6.3 MM JACK MONO

Item No.	Length		
K4IPP0030	0.3 m	K4IPP0450	4.5 m
K4IPP0060	0.6 m	K4IPP0600	6.0 m
K4IPP0090	0.9 m	K4IPP0900	9.0 m
K4IPP0150	1.5 m		
K4IPP0300	3.0 m		

#### CONNECTORS:

- RP2C
- RP2C



### K4IPR INSTRUMENT CABLE

REAN 6.3 MM JACK MONO TO 6.3 MM ANGLED JACK MONO

Item No.	Length		
K4IPR0300	3.0 m		
K4IPR0600	6.0 m		
K4IPR0900	9.0 m		

#### CONNECTORS:

- RP2C
- RP2RC



### K4IRR INSTRUMENT CABLE

REAN 6.3 MM ANGLED JACK MONO TO 6.3 MM ANGLED JACK MONO

Item No.	Length		
K4IRR0015	0.15 m	K4IRR0300	3.0 m
K4IRR0030	0.3 m	K4IRR0450	4.5 m
K4IRR0060	0.6 m	K4IRR0600	6.0 m
K4IRR0090	0.9 m		
K4IRR0150	1.5 m		

#### CONNECTORS:

- RP2RC
- RP2RC



# INSTRUMENT CABLES



For low profile connections, this cable features our 7525 shallow depth 6.35 mm right angle pancake plugs with gold plated tip. The cable used is our flexible #7117 high-end instrument cable with finely stranded 0.75 mm<sup>2</sup> conductor and low capacitance for detailed, uncolored signal transfer and extended frequency response. Dual shielding prevents handling noise and electromagnetic interference.

## FEATURES

- High-end instrument cable with neutral transmission over the whole frequency range
- Rugged, durable structure due to a special high quality PVC jacket

## SPECIFICATIONS

Product type:	Instrument cable
Colour:	black
Overall diameter:	7.0 mm +/- 0.2 mm
Jacket material:	PVC
AWG:	19
cross section:	0.75 mm <sup>2</sup>
Insulation:	PE 3.1 mm
Composition of conductor:	42 x 0.15 mm, tin plated copper, OFC

Number of inner conductors:	1
Shielding:	tin plated copper braided shielding with 128 x 0.10 mm + semiconductor
Conductor resistance:	25 Ω/km
Capacitance Cond./Shield.:	88 pF/m
Insulation Resistance:	> 50 MΩ
Working Temperature:	-20° to +70°

## K4IRRFL SPEAKER CABLE

WITH 6.35 MM FLAT PLUGS, MONO

Item No.	Length	CONNECTORS:
K4IRR0020FL	0.2 m	▪ 7525
K4IRR0030FL	0.3 m	▪ 7525
K4IRR0050FL	0.5 m	
K4IRR0100FL	1.0 m	
K4IRR0300FL	3.0 m	
K4IRR0600FL	6.0 m	





## MICROPHONE CABLES



Unbalanced instrument cable for onstage use. Like all cables in the 4-Star series, it is manufactured using high-quality REAN © components and highly flexible cable material. The tightly braided shielding guarantees optimal audio transmission. Practical for live use; the perfect choice for patching or transmission of line signals onstage.

### FEATURES

- Flexible Microphone cable with genuine high reliable Rean XLR connector
- Very good shielding and fine stranded wire for high-quality transmission

### SPECIFICATIONS

Product type:	Microphone cable
Colour:	black
Overall diameter:	5.8 mm +/- 0.2 mm
Jacket material:	PVC
AWG:	24AWG
cross section:	0.22 mm <sup>2</sup>
Insulation:	PE 1.50mm
Composition of conductor:	28 x 0.10 mm, bare cooper, OFC

Number of inner conductors:	2
Shielding:	cooper spiral shielding
Conductor resistance:	80 Ω/km
Capacitance Cond./Cond.:	<90 pF/m
Capacitance Cond./Shield.:	160 pF/m
Working Temperature:	-20° to +70°
Surge Impedance:	100ohm

### K4MMF MICROPHONE CABLE

REAN XLR MALE TO XLR FEMALE

Item No.	Length		
K4MMF0050	0.5 m	K4MMF0750	7.5 m
K4MMF0100	1.0 m	K4MMF1000	10.0 m
K4MMF0150	1.5 m	K4MMF1500	15.0 m
K4MMF0250	2.5 m	K4MMF2000	20.0 m
K4MMF0500	5.0 m	K4MMF3000	30.0 m

#### CONNECTORS:

- RC3M
- RC3F



### K4MFP MICROPHONE CABLE

REAN XLR FEMALE TO 6.3 MM JACK MONO

Item No.	Length		
K4MFP0030	0.3 m	K4MFP0750	7.5 m
K4MFP0150	1.5 m	K4MFP0900	9.0 m
K4MFP0300	3.0 m	K4MFP1000	10.0 m
K4MFP0500	5.0 m		
K4MFP0600	6.0 m		

#### CONNECTORS:

- RC3F
- RP2C



### K4MMP MICROPHONE CABLE

REAN XLR MALE TO 6.3 MM JACK MONO

Item No.	Length		
K4MMP0150	1.5 m	K4MMP0900	9.0 m
K4MMP0300	3.0 m	K4MMP1000	10.0 m
K4MMP0500	5.0 m	K4IRR0600	6.0 m
K4MMP0600	6.0 m		
K4MMP0750	7.5 m		

#### CONNECTORS:

- RC3M
- RP2C



# MICROPHONE CABLES



This OCC cable made especially for Adam Hall is impressive because of the extremely high degree of purity of the copper structure. In comparison with standard OFC copper cables, this physical property is attained by using larger crystals. The Adam Hall Krystal OCC microphone cable has 2 x 0.22 mm<sup>2</sup> inner conductors and braided shielding (shielding > 98%). With an external diameter of 6.5 mm, it is impressively robust while offering maximum flexibility.

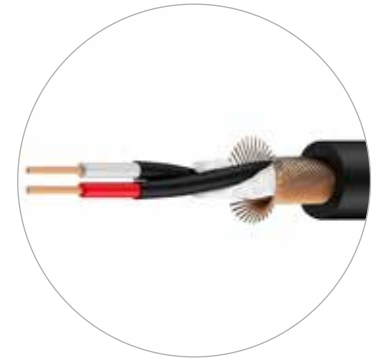

## FEATURES

- High flexible microphone cable with high reliable Yongsheng by Neutrik XLR connectors
- Extremely robust and very thick soft PVC jacket
- Very good shielding and fine stranded wire for high-quality transmission

## SPECIFICATIONS

Product type:	Microphone cable
Colour:	black
Overall diameter:	6.5 mm +/- 0.2 mm
Jacket material:	PVC
AWG:	24
cross section:	0.22 mm <sup>2</sup>
Insulation:	PE 1.4 mm
Composition of conductor:	27 x 0.12 mm, bare cooper, OFC

Number of inner conductors:	2
Shielding:	cooper spiral shielding
Conductor resistance:	64 Ω/km
Capacitance Cond./Cond.:	60/ pF/m
Capacitance Cond./Shield.:	110 pF/m
Insulation Resistance:	> 1GΩ x km
Working Temperature:	-20° to +70°
Surge Impedance:	100 ohm

## K4KMMF MICROPHONE CABLE

OCC XLR FEMALE TO XLR MALE

Item No.	Length		
K4KMMF0050	0.5 m	K4KMMF0750	7.5 m
K4KMMF0100	1.0 m	K4KMMF1000	10.0 m
K4KMMF0150	1.5 m	K4KMMF1500	15.0 m
K4KMMF0250	2.5 m	K4KMMF2000	20.0 m
K4KMMF0500	5.0 m		

### CONNECTORS:

- YS137L-BG
- YS136L-BG



## BALANCED AUDIO CABLES

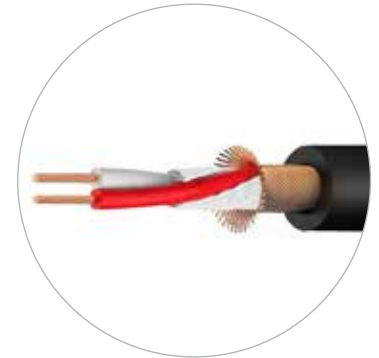

Balanced microphone or signal cable, equipped, like all cables in the K4MFP series, with female XLR plugs and 6.3 mm TRS stereo plugs by REAN® - making it the ideal choice for transmitting microphone signals to the board. The highly flexible cable has a braided shield and thus guarantees interference-free signal transmission.

### FEATURES

- Flexible Microphone cable with genuine high reliable Rean XLR connectors
- Very good shielding and fine stranded wire for high-quality transmission

### SPECIFICATIONS

Product type:	Microphone cable
Colour:	black
Overall diameter:	5,8 mm +/- 0,2 mm
Jacket material:	PVC
AWG:	24AWG
cross section:	0,22 mm <sup>2</sup>
Insulation:	PE 1,50mm
Composition of conductor:	28 x 0,10 mm, bare cooper, OFC

Number of inner conductors:	2
Shielding:	cooper spiral shielding
Conductor resistance:	80 Ω/km
Capacitance Cond./Cond.:	<90 pF/m
Capacitance Cond./Shield:	160 pF/m
Working Temperature:	-20° to +70°
Surge Impedance:	100ohm

### K4BFV BALANCED AUDIO CABLE

REAN XLR FEMALE TO 6.3 MM JACK STEREO

Item No.	Length	K4BFV0600	6.0 m
K4BFV0030	0.3 m	K4BFV0750	7.5 m
K4BFV0060	0.6 m	K4BFV1000	10.0 m
K4BFV0150	1.5 m		
K4BFV0300	3.0 m		
K4BFV0500	5.0 m		

#### CONNECTORS:

- RC3F
- RP3C



### K4BMV BALANCED AUDIO CABLE

REAN XLR MALE TO 6.3 MM JACK STEREO

Item No.	Length	K4BMV0600	6.0 m
K4BMV0030	0.3 m	K4BMV0750	7.5 m
K4BMV0060	0.6 m	K4BMV1000	10.0 m
K4BMV0150	1.5 m		
K4BMV0300	3.0 m		
K4BMV0500	5.0 m		

#### CONNECTORS:

- RC3M
- RP3C



### K4BVV BALANCED AUDIO CABLE

PATCH CABLE REAN 6.3 MM JACK STEREO TO 6.3 MM JACK STEREO

Item No.	Length	K4BVV0300	3.0 m
K4BVV0060	0.6 m	K4BVV0600	6.0 m
K4BVV0090	0.9 m	K4BVV0900	9.0 m
K4BVV0150	1.5 m		

#### CONNECTORS:

- RP3C
- RP3C



# HEADPHONE EXTENSION CABLES

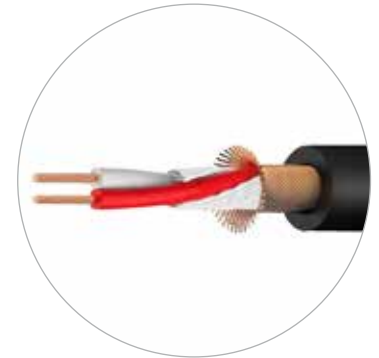

Balanced microphone or signal cable, equipped, like all cables in the K4MFP series, with female XLR plugs and 6.3 mm TRS stereo plugs by REAN® - making it the ideal choice for transmitting microphone signals to the board. The highly flexible cable has a braided shield and thus guarantees interference-free signal transmission.

## FEATURES

- Flexible Microphone cable with genuine high reliable Rean XLR connectors
- Very good shielding and fine stranded wire for high-quality transmission

## SPECIFICATIONS

Product type:	Microphone cable
Colour:	black
Overall diameter:	5.8 mm +/- 0.2 mm
Jacket material:	PVC
AWG:	24AWG
cross section:	0.22 mm <sup>2</sup>
Insulation:	PE 1.50mm
Composition of conductor:	28 x 0.10 mm, bare cooper, OFC

Number of inner conductors:	2
Shielding:	cooper spiral shielding
Conductor resistance:	80 Ω/km
Capacitance Cond./Cond.:	<90 pF/m
Capacitance Cond./Shield.:	160 pF/m
Working Temperature:	-20° to +70°
Surge Impedance:	100ohm

## K4BYV HEADPHONE EXTENSION CABLE

HEADPHONE EXTENSION 3.5 MM JACK STEREO TO 6.3 MM JACK STEREO

Item No.	Length	CONNECTORS:
K4BYV0300	3.0 m	▪ RP3C
K4BYV0600	6.0 m	▪ NRA240-L



## K4BOV HEADPHONE CABLE

HEADPHONE EXTENSION 6.3 MM JACK STEREO TO 6.3 MM JACK STEREO

Item No.	Length	CONNECTORS:
K4BOV0300	3.0 m	▪ RP3C
K4BOV0600	6.0 m	▪ NRA2203-O



## AUDIO CABLES

The combination of high-quality cable material and REAN® plugs results in a durable and rugged cable for live, studio and Hifi applications.

### FEATURES

- High reliable, but still affordable audio cables for the most demanding live, Studio and hi-fi applications



### SPECIFICATIONS

Product type:	Audio cable
Colour:	black
Overall diameter:	4,3 mm +/- 0.2 mm
Jacket material:	PVC
AWG:	24
cross section:	0.22 mm <sup>2</sup>
Insulation:	PE 1.0 mm
Composition of conductor:	28 x 0.10 mm, bare cooper, OFC

Number of inner conductors:	2
Shielding:	cooper spiral shielding
Conductor resistance:	80 Ω/km
Capacitance Cond./Cond.:	90/ pF/m
Capacitance Cond./Shield.:	160 pF/m
Working Temperature:	-20° to +70°
Surge Impedance:	100 ohm

### K4TCC AUDIO CABLE

REAN 2 X RCA MALE TO 2 X RCA MALE

Item No.	Length	CONNECTORS:
K4TCC0030	0.3 m	▪ RF2C-AU-0
K4TCC0060	0.6 m	▪ RF2C-AU-2
K4TCC0090	0.9 m	
K4TCC0150	1.5 m	
K4TCC0300	3.0 m	
K4TCC0600	6.0 m	



### K4TPC MICROPHONE CABLE

AUDIO CABLE REAN 2 X RCA MALE TO 2 X 6.3 MM JACK MONO

Item No.	Length	CONNECTORS:
K4TPC0060	0.6 m	▪ RF2C-AU-0
K4TPC0090	0.9 m	▪ RF2C
K4TPC0150	1.5 m	
K4TPC0300	3.0 m	
K4TPC0600	6.0 m	



# AUDIO CABLES

## K4TPP AUDIO CABLE

REAN 2 X 6.3 MM JACK MONO TO 2 X 6.3 MM JACK MONO

Item No.	Length	CONNECTORS:
K4TPP0090	0.9 m	▪ RP2C
K4TPP0150	1.5 m	▪ RP2C
K4TPP0300	3.0 m	
K4TPP0600	6.0 m	

## K4YVMF AUDIO CABLE

REAN 6.3 MM JACK STEREO TO 1 X XLR MALE AND 1 X XLR FEMALE

Item No.	Length	CONNECTORS:
K4YVMF0180	1.8 m	▪ RC3F
K4YVMF0300	3.0 m	▪ RP3C

## K4YVPP AUDIO CABLE

REAN 6.3 MM JACK STEREO TO 2 X 6.3 MM JACK MONO

Item No.	Length	CONNECTORS:
K4YVPP0090	0.9 m	▪ RP2C
K4YVPP0150	1.5 m	▪ RP3C
K4YVPP0300	3.0 m	
K4YVPP0600	6.0 m	

## K4YWCC AUDIO CABLE

REAN 3.5 MM JACK STEREO TO 2 X RCA MALE

Item No.	Length	CONNECTORS:
K4YWCC0090	0.9 m	▪ RF2C-AU-0
K4YWCC0150	1.5 m	▪ RTP3C
K4YWCC0300	3.0 m	
K4YWCC0600	6.0 m	



## AUDIO CABLES

The combination of high-quality cable material and REAN<sup>®</sup> plugs results in a durable and rugged cable for live, studio and Hifi applications.

### FEATURES

- High reliable, but still affordable audio cables for the most demanding live, Studio and hi-fi applications



### K4YWFF AUDIO CABLE

REAN 3.5 MM JACK STEREO TO 2 X XLR FEMALE

Item No.	Length
K4YWFF0180	1.8 m
K4YWFF0300	3.0 m

#### CONNECTORS:

- Model number connector 1-A & 1-B: RC3F
- RTP3C



### K4YWMM AUDIO CABLE

REAN 3.5 MM JACK STEREO TO 2 X XLR FEMALE

Item No.	Length
K4YWMM0180	1.8 m
K4YWMM0300	3.0 m

#### CONNECTORS:

- Model number connector 1-A & 1-B: RC3M
- RTP3C



### K4YWPP AUDIO CABLE

REAN 3,5 MM JACK STEREO TO 2 X 6.3 MM JACK MONO

Item No.	Length
K4YWPP0090	0.9 m
K4YWPP0150	1.5 m
K4YWPP0300	3.0 m
K4YWPP0600	6.0 m

#### CONNECTORS:

- Model number connector 1-A & 1-B: RP2C
- RTP3C





# DMX - AES/EBU CABLES

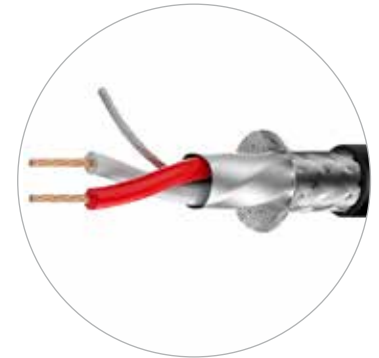

Data cable for transmission of DMX signals or for transmission of digital audio signals in AES/EBU format. Double shielding with spiral copper strands and an additional conductive foil shield for optimum resistance to interference, yet the cable remains highly flexible and rugged. Equipped with 3-pin XLR connectors by REAN ©.

## FEATURES

- High Flexible AES/EBU and DMX-conformant oxygen free cable

## SPECIFICATIONS

Typ:	DMX AES/EBU Cable
Color:	black
Overall diameter:	4,5 mm +/- 0.1mm
Conductor area:	0,22 mm <sup>2</sup>
AWG (American Wire Gauge):	24
Conductor material:	bare copper, OFC
Composition of conductor:	7 x 0,20 mm
Screen material:	copper wire screen

Screen:	spiral wound
Conductor resistance:	68 Ohm / km
Capacity:	< 52 pF/m
Overall jacket material:	PVC mat

## K4DMF DMX CABLE

REAN XLR MALE TO XLR FEMALE

Item No.	Length		
K4DMF0050	0.5 m	K4DMF1500	15.0 m
K4DMF0100	1.5 m	K4DMF2000	20.0 m
K4DMF0300	3.0 m	K4DMF3000	30.0 m
K4DMF0500	5.0 m		
K4DMF1000	10.0 m		

### CONNECTORS:

- RC3F
- RC3M



## DMX - AES/EBU CABLES

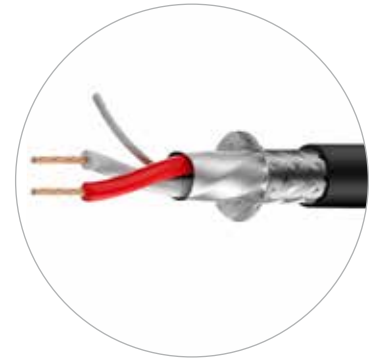

**IP65**

This high-quality cable assembly uses highly flexible AES/EBU & DMX cable with twin OFC conductors, copper spiral plus AL/PT foil shielding and rugged PVC jacket. It is equipped with heavy-duty, IP65 rated male and female XLR connectors that are protected against dust and water ingress.

### FEATURES

- with Professional Heavy-duty connector suitable for outdoor use
- Dust- and waterproof grade IP65

### SPECIFICATIONS

Product type:	AES / EBU & DMX Cable
Colour:	black
Overall diameter:	6.5 mm +/- 0.2 mm
Jacket material:	PVC
AWG:	22
cross section:	0.34 mm <sup>2</sup>
Insulation:	PE 1,7 mm
conductor material:	bare cooper, OFC
Conductor construction:	7x 0.25 mm
Number of inner conductors:	2

Shielding:	cooper spiral shielding with 80 x 0,10 mm + AL/PT-foil + PE filler
Conductor resistance:	53 ohm/km
Capacitance Cond./Cond.:	< 65 pF/m
Capacitance Cond./Shield.:	115pF/m
Insulation Resistance:	> 10 Gohm x km
Working Temperature:	-20° to +70°
Surge Impedance:	110 ohm

### K4DGHIP65 AUDIO CABLE

5-POL XLR MALE TO XLR FEMALE IP65

Item No.	Length		
K4DGH0050IP65	0.5 m	K4DGH1500IP65	15.0 m
K4DGH0150IP65	1.5 m	K4DGH2000IP65	20.0 m
K4DGH0300IP65	3.0 m	K4DGH3000IP65	30.0 m
K4DGH0500IP65	5.0 m		
K4DGH1000IP65	10.0 m		

#### CONNECTORS:

- 7890
- 7891



### K4DMFIP65 DMX CABLE

3-POL XLR MALE TO XLR FEMALE IP65

Item No.	Length		
K4DMF0050IP65	0.5 m	K4DMF1500IP65	15.0 m
K4DMF0150IP65	1.5 m	K4DMF2000IP65	20.0 m
K4DMF0300IP65	3.0 m	K4DMF3000IP65	30.0 m
K4DMF0500IP65	5.0 m		
K4DMF1000IP65	10.0 m		

#### CONNECTORS:

- 7888
- 7889



# SPEAKER CABLES



Professional highly flexible speaker cable with a rugged PVC jacket.  
Conductor cross-section 2 x 1.5 mm<sup>2</sup>, with precisely crafted Adam Hall 7884 Standard Speaker Connectors for optimal contact. Optimal for use as a patch cable or connection cable.

## FEATURES

- Highly durable and flexible Loudspeaker cable with OFC cooper strands to ensure high performance transmission quality
- Equipped with Precisely crafted ah connector for high reliable connectivity

## SPECIFICATIONS

	<b>K4S215SS</b>	<b>K4S225SS</b>	<b>K4S240SS</b>	<b>K4S22425SS</b>
Product type:	Speaker cable	Speaker cable	Speaker cable	Speaker cable
Colour:	black	black	black	black
Overall diameter:	7.0 mm +/- 0.2 mm	8.0 mm +/- 0.2 mm	11.0 mm +/- 0.2 mm	11.0 mm +/- 0.2 mm
Jacket material:	PVC	PVC	PVC	PVC
AWG:	16	14	12	13
cross section:	1.5 mm <sup>2</sup>	2.5 mm <sup>2</sup>	4 mm <sup>2</sup>	2.5 mm <sup>2</sup>
Composition of conductor:	48 x 0.20 mm, Copper bare, OFC	80 x 0.20 mm, Copper bare, OFC	80 x 0.25 mm, bare cooper, OFC	80 x 0.20 mm, bare cooper, OFC
Number of inner conductors:	2	2	2	4
conductor PVC insulation diameter	2.7 mm	3.1 mm	4.0 mm	3.1 mm
Conductor resistance:	13Ω / km	7.8 Ω / km	4.5 Ω / km	7 Ω / km
Working Temperature:	-20° to +70°	-20° to +70°	-20° to +70°	-20° to +70°
Connector:	2 x 7884	2 x 7884	2 x 7884	2 x 7884

### K4S215SS SPEAKER CABLE

2 X 1,5 MM<sup>2</sup> STANDARD SPEAKER CONNECTOR 2-POLE TO STANDARD SPEAKER CONNECTOR 2-POLE

Item No.	Length
K4S215SS0100	1.0
K4S215SS0200	2.0
K4S215SS0300	3.0
K4S215SS0500	5.0
K4S215SS1000	10.0

### K4S225SS SPEAKER CABLE

2 X 2,5 MM<sup>2</sup> STANDARD SPEAKER CONNECTOR 2-POLE TO STANDARD SPEAKER CONNECTOR 2-POLE

Item No.	Length
K4S225SS0100	1.0 m
K4S225SS0200	2.0 m
K4S225SS0500	5.0 m
K4S225SS1000	10.0 m
K4S225SS1500	15.0 m
K4S225SS2000	20.0 m



### K4S240SS SPEAKER CABLE

2 X 4 MM<sup>2</sup> STANDARD SPEAKER CONNECTOR 2-POLE TO STANDARD SPEAKER CONNECTOR 2-POLE

Item No.	Length
K4S240SS0200	2.0 m
K4S240SS0500	5.0 m
K4S240SS1000	10.0 m
K4S240SS1500	15.0 m
K4S240SS2000	20.0 m

### K4S425SS SPEAKER CABLE

4 X 2,5 MM<sup>2</sup> STANDARD SPEAKER CONNECTOR 4-POLE TO STANDARD SPEAKER CONNECTOR 4-POLE

Item No.	Length
K4S425SS0040	0.4 m
K4S425SS0300	3.0 m
K4S425SS1000	10.0 m
K4S425SS1500	15.0 m
K4S425SS2000	20.0 m



## CAT5E DATA CABLES



This EtherSound compatible CAT5e cable uses a highly flexible low smoke zero halogen jacket and braid shield of 128 tinned copper strands with four twisted pairs of conductors. It is terminated with professional RJ45 connectors featuring a removable die-cast shell to enable connection to standard RJ45 sockets.

### FEATURES

- High-flexibility LSZH CAT5e cable
- Professional RJ 45 cable AH connector
- Removable connector shell enables plugging into standard RJ45 socket
- EtherSound compatible, Flame-retardant TPU jacket

### SPECIFICATIONS

Product type:	CAT5e data cable
Colour:	blue
Overall diameter:	6.4 mm +/- 0.2 mm
Jacket material:	TPU
AWG:	26
cross section:	0.15 mm <sup>2</sup>
Insulation:	HDPE
Composition of conductor:	19 x 0.10 mm, bare cooper, OFC
Number of inner conductors:	4x2
Shielding:	tin plated copper braided shielding with 128 x 0.10mm

Conductor resistance:	< 85 Ω/km
Capacitance Cond./Cond.:	60 pF/m
Capacitance Cond./Shield.:	110 pF/m
Insulation Resistance:	> 10 GΩ
Working Temperature:	-40° to +85°
Surge Impedance:	100 ohm
Other features	Flame retardant, Halogen-free

### K4CAT## CABLE CAT5E

RJ45 A RJ45

Item No.	Length		
K4CAT50050	0,5 m	K4CAT51500	15 m
K4CAT50100	1 m	K4CAT52000	20 m
K4CAT50300	3 m	K4CAT55000	50 m
K4CAT50500	5 m	K4CAT57000	70 m
K4CAT51000	10 m		

#### CONNECTORS:

- 7897
- 7897



# CAT5E DATA CABLES



This EtherSound compatible CAT5e cable uses a highly flexible low smoke zero halogen jacket and braid shield of 128 tinned copper strands with four twisted pairs of conductors. It is terminated with rugged industrial grade RJ 45 connectors.

## FEATURES

- High-flexibility LSZH CAT5e
- cable equipped with special RJ 45 Industrial AH Connectors
- EtherSound compatible, Flame-retardant TPU jacket

## SPECIFICATIONS

Product type:	CAT5e data cable
Colour:	blue
Overall diameter:	6.4 mm +/- 0.2 mm
Jacket material:	TPU
AWG:	26
cross section:	0.15 mm <sup>2</sup>
Insulation:	HDPE
Composition of conductor:	19 x 0.10 mm, bare cooper, OFC
Number of inner conductors:	4x2
Shielding:	tin plated copper braided shielding with 128 x 0.10mm

Conductor resistance:	< 85 Ω/km
Capacitance Cond./Cond.:	60 pF/m
Capacitance Cond./Shield.:	110 pF/m
Insulation Resistance:	> 10 GΩ
Working Temperature:	-40° to +85°
Surge Impedance:	100 ohm
Other features	Flame retardant, Halogen-free

## K4CATI CABLE CAT5E

RJ45 A RJ45

Item No.	Length
K4CAT50100I	1 m
K4CAT50300I	3 m
K4CAT50500I	5 m
K4CAT51000I	10 m
K4CAT51500I	15 m
K4CAT52000I	20 m

### CONNECTORS:

- 7887
- 7887

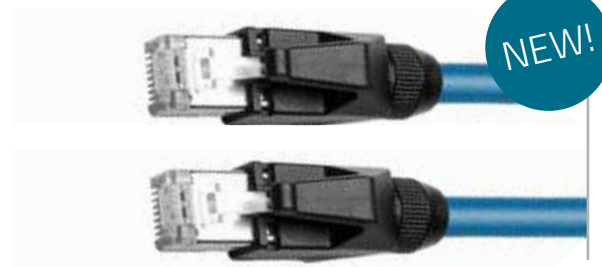







# **3STAR** SERIES ★★ ★

PREMIUM  
**QUALITY CABLES**

Our High-Quality cable series with Adam Hall® quality connectors for reliable connections since 1980.

## INSTRUMENT CABLES

Instrument cable with TRS plugs from Adam Hall - proven since 1980, rugged, and still affordable. This cable guarantees optimal shielding against background noise with spiral shielding and an additional foil shield. Equipped with straight, unbalanced plugs.



### FEATURES

- Instrument Cable with fine stranded wire for high-quality signal transmission
- 100% protected due to double shielding
- High flexibility makes it easy to wind
- Extremely good price-performance ratio

### SPECIFICATIONS

Product type:	Instrument cables
Colour:	black
Overall diameter:	6.0 mm +/- 0.2 mm
Jacket material:	PVC
AWG:	23AWG
cross section:	0.22 mm <sup>2</sup>
Insulation:	PE 1.4mm
Composition of conductor:	20 x 0.12mm, bare cooper, OFC

Number of inner conductors:	1
Shielding:	cooper spiral shielding with 64 x 0,12 mm + semiconductor
Conductor resistance:	90 Ω/km
Capacitance Cond./Shield.:	8 pF/m
Insulation Resistance:	> 1 GΩ x km
Working Temperature:	-20° to +70°

### K3IPP INSTRUMENT CABLE

6.3 MM JACK MONO TO 6.3 MM JACK MONO

Item No.	Length	CONNECTORS:
K3IPP0300	3.0 m	▪ Custom-made
K3IPP0600	6.0 m	▪ Custom-made
K3IPP0900	9.0 m	



### K3IPR INSTRUMENT CABLE

6.3 MM JACK MONO TO 6.3 MM ANGLED JACK MONO

Item No.	Length	CONNECTORS:
K3IPR0300	3.0 m	▪ Custom-made
K3IPR0600	6.0 m	▪ Custom-made
K3IPR0900	9.0 m	



# INSTRUMENT CABLES

## K3IRR INSTRUMENT CABLE

6.3 MM ANGLED JACK MONO TO 6.3 MM ANGLED JACK MONO

Item No.	Length	CONNECTORS:
K3IRR0015	0.15 m	▪ Custom-made
K3IRR0030	0.30 m	▪ Custom-made
K3IRR0060	0.60 m	

## K3IPPP INSTRUMENT CABLE

6.3 MM JACK MONO TO 6.3 MM JACK MONO

Item No.	Length	CONNECTORS:
K3IPPP0300P	3.0 m	▪ Custom-made
K3IPPP0600P	6.0 m	▪ Custom-made
K3IPPP0900P	9.0 m	

## K3IPRP INSTRUMENT CABLE

6.3 MM JACK MONO TO 6.3 MM ANGLED JACK MONO

Item No.	Length	CONNECTORS:
K3IPRP0300P	3.0 m	▪ Custom-made
K3IPRP0600P	6.0 m	▪ Custom-made
K3IPRP0900P	9.0 m	

## K3IPPS INSTRUMENT CABLE

6.3 MM JACK MONO TO 6.3 MM JACK MONO

Item No.	Length	CONNECTORS:
K3IPPS0300S	3.0 m	▪ Custom-made
K3IPPS0600S	6.0 m	▪ Custom-made
K3IPPS0900S	9.0 m	

## K3IPPV VINTAGE INSTRUMENT CABLE

6.3 MM JACK MONO TO 6.3 MM JACK MONO

Item No.	Length	CONNECTORS:
K3IPPV0300V	3.0 m	▪ Custom-made
K3IPPV0600V	6.0 m	▪ Custom-made
K3IPPV0900V	9.0 m	

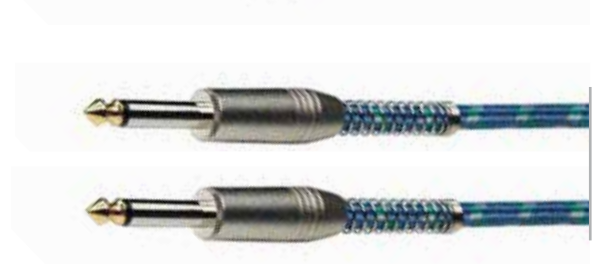

## MICROPHONE CABLES

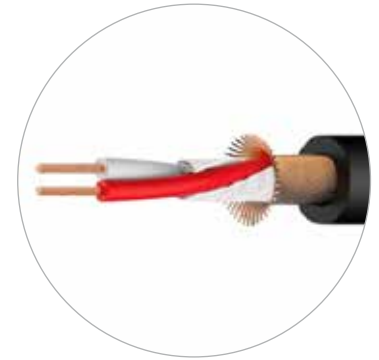

Balanced microphone cable with XLR plugs on both ends. Equipped with Adam Hall plugs and high-quality cable material. Despite the small cable diameter, this cable impresses with high stability and optimal coiling characteristics.

### FEATURES

- Extremely good price-performance ratio high flexible microphone cable with robust AH Connectors

### SPECIFICATIONS

Product type	Microphone cable
Colour:	black
Overall diameter:	6.0 mm +/- 0.2 mm
Jacket material:	PVC
AWG:	22AWG
cross section:	0.31 mm <sup>2</sup>
Insulation:	PE 1.50mm
Composition of conductor:	28 x 0.12 mm, bare cooper, OFC

Number of inner conductors:	2
Shielding:	tin plated cooper spiral shielding with 96 x 0,12 mm
Conductor resistance:	55 Ω/km
Capacitance Cond./Cond.:	<72 pF/m
Capacitance Cond./Shield.:	130 pF/m
Insulation Resistance:	> 1 GΩ
Working Temperature:	-20° to +70°
Surge Impedance:	100ohm

### K3MMF MICROPHONE CABLE XLR FEMALE TO XLR MALE

Item No.	Length	Item No.	Length
K3MMF0050	0.5 m	K3MMF1500	15.0 m
K3MMF0100	1.0 m	K3MMF2000	20.0 m
K3MMF0300	3.0 m	K3MMF3000	30.0 m
K3MMF0600	6.0 m		
K3MMF1000	10.0 m		

#### CONNECTORS:

- Custom-made
- Custom-made



### K3MFP MICROPHONE CABLE XLR FEMALE TO 6.3 MM JACK MONO

Item No.	Length	CONNECTORS:
K3MFP0100	1.0 m	▪ Custom-made
K3MFP0300	3.0 m	▪ Custom-made
K3MFP0600	6.0 m	
K3MFP1000	10.0 m	



### K3MMP MICROPHONE CABLE XLR MALE TO 6.3 MM JACK MONO

Item No.	Length	CONNECTORS:
K3MMP0100	1.0 m	▪ Custom-made
K3MMP0300	3.0 m	▪ Custom-made
K3MMP0600	6.0 m	
K3MMP1000	10.0 m	



# BALANCED AUDIO CABLES

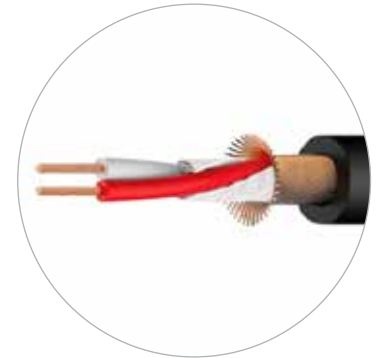

Balanced signal cable with a 6.3 millimetre TRS plug and a female XLR plug, thus suitable for transmission of sensitive microphone signals to the mixing desk or amplifier. Uses original Adam Hall plugs and high-quality cable material.

## FEATURES

- Extremely good price-performance ratio high flexible balanced audio cable with robust AH Connectors

## SPECIFICATIONS

Product type	Microphone cable
Colour:	black
Overall diameter:	6.0 mm +/- 0.2 mm
Jacket material:	PVC
AWG:	22AWG
cross section:	0.31 mm <sup>2</sup>
Insulation:	PE 1.50mm
Composition of conductor:	28 x 0.12 mm, bare cooper, OFC

Number of inner conductors:	2
Shielding:	tin plated cooper spiral shielding with 96 x 0,12 mm
Conductor resistance:	55 Ω/km
Capacitance Cond./Cond.:	<72 pF/m
Capacitance Cond./Shield.:	130 pF/m
Working Temperature:	-20° to +70°
Surge Impedance:	100ohm

## K3BFV BALANCED AUDIO CABLE

XLR FEMALE TO 6.3 MM JACK STEREO

Item No.	Length	CONNECTORS:
K3BFV0100	1.0 m	▪ Custom-made
K3BFV0300	3.0 m	▪ Custom-made
K3BFV0600	6.0 m	
K3BFV01000	10.0 m	



## K3BMV BALANCED AUDIO CABLE

XLR MALE TO 6.3 MM JACK STEREO

Item No.	Length	CONNECTORS:
K3BMV0100	1.0 m	▪ Custom-made
K3BMV0300	3.0 m	▪ Custom-made
K3BMV0600	6.0 m	
K3BMV1000	10.0 m	



## BALANCED AUDIO CABLES

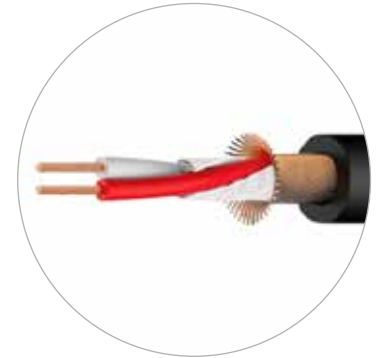

Balanced signal cable with a 6.3 millimetre TRS plug and a female XLR plug, thus suitable for transmission of sensitive microphone signals to the mixing desk or amplifier. Uses original Adam Hall plugs and high-quality cable material.

### FEATURES

- Extremely good price-performance ratio high flexible balanced audio cable with robust AH Connectors

### SPECIFICATIONS

Product type	Microphone cable
Colour:	black
Overall diameter:	6.0 mm +/- 0.2 mm
Jacket material:	PVC
AWG:	22AWG
cross section:	0.31 mm <sup>2</sup>
Insulation:	PE 1.50mm
Composition of conductor:	28 x 0.12 mm, bare cooper, OFC

Number of inner conductors:	2
Shielding:	tin plated cooper spiral shielding with 96 x 0,12 mm
Conductor resistance:	55 Ω/km
Capacitance Cond./Cond.:	<72 pF/m
Capacitance Cond./Shield.:	130 pF/m
Working Temperature:	-20° to +70°
Surge Impedance:	100ohm

### K3BVV AUDIO CABLE

6.3 MM JACK STEREO TO 6.3 MM JACK STEREO

Item No.	Length	Item No.	Length
K3BVV0060	0.6 m	K3BVV0300	3.0 m
K3BVV0090	0.9 m	K3BVV0600	6.0 m
K3BVV0150	1.5 m	K3BVV0900	9.0 m

#### CONNECTORS:

- Custom-made
- Custom-made



### K3BVVECO PATCH CABLE

6.3 MM JACK STEREO TO 6.3 MM JACK STEREO

Item No.	Length	CONNECTORS:
K3BVV0030ECO	0.3 m	▪ Custom-made
K3BVV0060ECO	0.6 m	▪ Custom-made
K3BVV0090ECO	0.9 m	



### K3BVVSET PATCH CABLE

6 CABLES 6.3 MM JACK STEREO TO 6.3 MM JACK STEREO

Item No.	Length	CONNECTORS:
K3BVV0030SET	0.3 m	▪ Custom-made
K3BVV0060SET	0.6 m	▪ Custom-made
K3BVV0090SET	0.9 m	
K3BVV0120SET	1.2 m	





# AUDIO CABLES



High-quality stereo audio cable with all-metal RCA plugs with gold-plated contacts on both ends. Clear identification of the channels with engraved colour rings, spring strain relief, and high-quality cable material round out the features of this cable. Equally suitable for studio or ambitious hi-fi applications.

## SPECIFICATIONS

	K3TCC	K3TPC	K3TPP
Type:	twin audio cable	twin audio cable	twin audio cable
Colour:	black	black	black
Cable diameter:	5.8 mm	5.8 mm	5.8 mm
Center conductor cross section:	0.22 mm <sup>2</sup>	0.22 mm <sup>2</sup>	0.22 mm <sup>2</sup>
Connector 1:	RCA	RCA	6.3 mm Jack
Connector 2:	RCA	6.3 mm Jack	6.3 mm Jack

### K3TCC AUDIO CABLE

2 X RCA MALE TO 2 X RCA MALE

Item No.	Length
K3TCC0100	1.0 m
K3TCC0300	3.0 m
K3TCC0600	6.0 m

### K3TPC AUDIO CABLE

2 X RCA MALE TO 2 X 6.3 MM JACK MONO

Item No.	Length
K3TPC0100	1.0 m
K3TPC0300	3.0 m
K3TPC0600	6.0 m

### K3TPP AUDIO CABLE

2 X 6.3 MM JACK MONO TO 2 X 6.3 MM JACK MONO

Item No.	Length
K3TPP0100	1.0 m
K3TPP0300	3.0 m
K3TPP0600	6.0 m



## AUDIO CABLES



Insert or Y-cable for looping external devices into the signal path or connecting stereo line signals to a mixing desk or amplifier. Cable with moulded-on 6.3 millimetre TRS connectors, two mono, one stereo.

### SPECIFICATIONS

	K3YVPP	K3YWCC	K3YWPP
Type:	Y-cable	Y-cable	Y-cable
Colour:	black	black	black
Cable diameter:	5.8 mm	5.8 mm	5.8 mm
Center conductor cross section:	0.22 mm <sup>2</sup>	0.22 mm <sup>2</sup>	0.22 mm <sup>2</sup>
Connector 1-A:	6.3 mm Jack	RCA	6.3 mm Jack
Connector 1-B:	6.3 mm Jack	RCA	6.3 mm Jack
Connector 2:	6.3 mm Jack	3.5 mm Jack	3.5 mm Jack

### K3YVPP AUDIO CABLE

6.3 MM JACK STEREO TO 2 X 6.3 MM JACK MONO

Item No.	Length
K3YVPP0100	1.0 m
K3YVPP0300	3.0 m
K3YVPP0600	6.0 m



### K3YWCC AUDIO CABLE

3.5 MM JACK STEREO TO 2 X RCA MALE

Item No.	Length
K3YWCC0100	1.0 m
K3YWCC0300	3.0 m
K3YWCC0600	6.0 m



### K3YWPP AUDIO CABLE

3.5 MM JACK STEREO TO 2 X 6.3 MM JACK MONO

Item No.	Length
K3YWPP0100	1.0 m
K3YWPP0300	3.0 m
K3YWPP0600	6.0 m



# DMX - AES/EBU CABLES

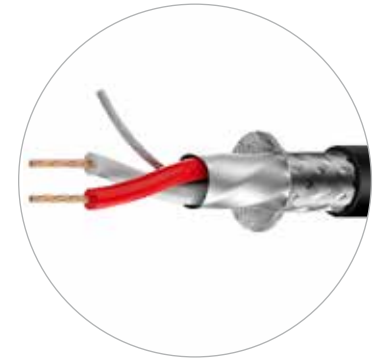

Data cable for transmission of DMX signals for lighting or AES/EBU signals for audio. Equipped with professional XLR connectors by Adam Hall.

## FEATURES

- Highly flexible AES/EBU and DMX compliant cable
- High Quality signal transmission due to large conductor cross section and OFC strands and a very good shielding

## SPECIFICATIONS

Product type:	AES / EBU & DMX Cable
Colour:	black
Overall diameter:	5.8 mm +/- 0.2 mm
Jacket material:	PVC
AWG:	24
cross section:	0.22 mm <sup>2</sup>
Insulation:	PE 1,7 mm
Composition of conductor:	28 x 0.10 mm, bare cooper, OFC
Number of inner conductors:	2
Shielding:	tin plated copper braided shielding with 64 x 0.10mm + AL/PT-Foil + PE filler

Conductor resistance:	53 Ω/km
Capacitance Cond./Cond.:	< 68 pF/m
Capacitance Cond./Shield.:	45pF
Insulation Resistance:	>5 GΩ x km
Working Temperature:	-20° to +70°
Surge Impedance:	110 ohm

## K3DMF DMX CABLE

XLR MALE TO XLR FEMALE

Item No.	Length
K3DMF0050	0.5 m
K3DMF0150	1.5 m
K3DMF0300	3.0 m
K3DMF0600	6.0 m
K3DMF1000	10.0 m
K3DMF1500	15.0 m
K3DMF2000	20.0 m
K3DMF3000	30.0 m

### CONNECTORS:

- 7850
- 7849



## K3DGH DMX CABLE

XLR MALE 5-PIN TO XLR FEMALE 5-PIN

Item No.	Length
K3DGH0050	0.5 m
K3DGH0150	1.5 m
K3DGH0300	3.0 m
K3DGH0600	6.0 m
K3DGH1000	10.0 m

K3DGH1500	15.0 m
K3DGH2000	20.0 m
K3DGH3000	30.0 m

### CONNECTORS:

- 7885
- 7886



## DMX - AES/EBU CABLES

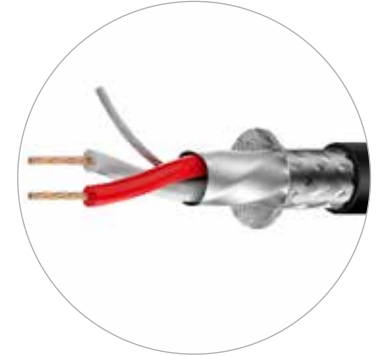

Data cable for transmission of DMX signals for lighting or AES/EBU signals for audio. Equipped with professional XLR connectors by Adam Hall.

### FEATURES

- Highly flexible AES/EBU and DMX compliant cable
- High Quality signal transmission due to large conductor cross section and OFC strands and a very good shielding

### SPECIFICATIONS

Product type:	AES / EBU & DMX Cable
Colour:	black
Overall diameter:	5.8 mm +/- 0.2 mm
Jacket material:	PVC
AWG:	24
cross section:	0.22 mm <sup>2</sup>
Insulation:	PE 1,7 mm
Composition of conductor:	28 x 0.10 mm, bare cooper, OFC
Number of inner conductors:	2
Shielding:	tin plated copper braided shielding with 64 x 0.10mm + AL/PT-Foil + PE filler

Conductor resistance:	53 Ω/km
Capacitance Cond./Cond.:	< 68 pF/m
Capacitance Cond./Shield.:	45pF
Insulation Resistance:	>5 GΩ x km
Working Temperature:	-20° to +70°
Surge Impedance:	110 ohm

### K3DGF DMX ADAPTER

XLR MALE 5-PIN TO XLR FEMALE 3-PIN

Item No.	Length	CONNECTORS:
K3DGF0020	0.2 m	<ul style="list-style-type: none"> <li>▪ 7850</li> <li>▪ 7849</li> </ul>



### K3DHM DMX ADAPTER

XLR FEMALE 5-PIN TO XLR MALE 3-PIN

Item No.	Length	CONNECTORS:
K3DHM0020	0.2 m	<ul style="list-style-type: none"> <li>▪ 7850</li> <li>▪ 7885</li> </ul>



# SPEAKER CABLES



Highly flexible speaker cable in different lengths ranging from one to twenty metres, featuring Speakon compatible connectors and a cable cross-section of 2 x 1.5 mm<sup>2</sup> and 2 x 2.5 mm<sup>2</sup>. Ideal for connection of low-output speaker systems.

## FEATURES

- Durable and flexible Loudspeaker cable with OFC copper strands to ensure high performance transmission quality

## SPECIFICATIONS

	<b>K3S215PP</b>	<b>K3S215SS</b>	<b>K3S225SS</b>
Product type:	Speaker cable	Speaker cable	Speaker cable
Colour:	dark grey	dark grey	dark grey
Overall diameter:	6.8 mm +/- 0.2 mm	6.8 mm +/- 0.2 mm	6.8 mm +/- 0.2 mm
Jacket material:	PVC	PVC	PVC
AWG:	16	16	16
cross section:	1.5 mm <sup>2</sup>	1.5 mm <sup>2</sup>	1.5 mm <sup>2</sup>
Composition of conductor:	30 x 0.25 mm, Copper bare, OFC	30 x 0.25 mm, Copper bare, OFC	30 x 0.25 mm, Copper bare, OFC
Number of inner conductors:	2	2	2
conductor PVC insulation diameter	2.6 mm	2.6 mm	2.6 mm
Conductor resistance:	13Ω / km	13Ω / km	13Ω / km
Working Temperature:	-20° to +70°	-20° to +70°	-20° to +70°
Connector:	2 x Custom-made	2 x Custom-made	2 x Custom-made

### K3S215PP SPEAKER CABLE

2 X 1.5 MM<sup>2</sup> 6.3 MM JACK MONO TO 6.3 MM JACK MONO

Item No.	Length
K3S215PP0150	1.5 m
K3S215PP0300	3.0 m
K3S215PP0500	5.0 m
K3S215PP1000	10.0 m



### K3S215SS SPEAKER CABLE

2 X 1.5 MM<sup>2</sup> STANDARD SPEAKER CONNECTOR 4-POLE TO STANDARD SPEAKER CONNECTOR 4-POLE

Item No.	Length
K3S215SS0200	2.0 m
K3S215SS0500	5.0 m
K3S215SS1000	10.0 m

### K3S225SS SPEAKER CABLE

2 X 2,5 MM<sup>2</sup> STANDARD SPEAKER CONNECTOR 4-POLE TO STANDARD SPEAKER CONNECTOR 4-POLE

Item No.	Length
K3S225SS0200	2.0 m
K3S225SS0500	5.0 m
K3S225SS1000	10.0 m
K3S225SS1500	15.0 m
K3S225SS2000	20.0 m



## MIDI CABLES



Studio- and stage-ready MIDI cable for use with keyboards, expanders or other MIDI equipment. Perfect for patching rack equipment. The four available colours (black, blue, green, red) make rack configurations easy to follow. Moulded-on plugs with additional strain relief at both ends.

### SPECIFICATIONS

	K3MIDI0075	K3MIDI0150	K3MIDI0300	K3MIDIBLK-5	K3MIDI
Type:	midi cable	midi cable	midi cable	midi cable	midi cable
Length:	0.75 m	1.5 m	3.0 m	3.0 m / 6.0 m	6.0 m
Colour:	black /blue/green/red	black /blue/green/red	black /blue/green	black	black/blue/green/red
Cable diameter:	5 mm	5 mm	5 mm	5 mm	5 mm
Center conductor cross section:	0.11 mm <sup>2</sup>	0.11 mm <sup>2</sup>	0.11 mm <sup>2</sup>	0.11 mm <sup>2</sup>	0.11 mm <sup>2</sup>
Connector 1:	DIN 5-pin	DIN 5-pin	DIN 5-pin	DIN 5-pin	DIN 5-pin
Connector 2:	DIN 5-pin	DIN 5-pin	DIN 5-pin	DIN 5-pin	DIN 5-pin

### K3MIDI0075 MIDI CABLE 0.75 M

Item No.	Color
K3MIDI0075BLK	black
K3MIDI0075BLU	blue
K3MIDI0075GRN	green
K3MIDI0075RED	red

### K3MIDI0150 MIDI CABLE 1.5 M

Item No.	Color
K3MIDI0150BLK	black
K3MIDI0150BLU	blue
K3MIDI0150GRN	green
K3MIDI0150RED	red

### K3MIDI0300 MIDI CABLE 3 M

Item No.	Color
K3MIDI0300BLK	black
K3MIDI0300BLU	blue
K3MIDI0300GRN	green

### K3MIDI0600 MIDI CABLE 6 M

Item No.	Color
K3MIDI0600BLK	black
K3MIDI0600BLU	blue
K3MIDI0600GRN	green
K3MIDI0600RED	red

### K3MIDI0300 MIDI CABLE BLACK 5-POLE

Item No.	Length
K3MIDI0300BLK-5	3.0 m
K3MIDI0600BLK-5	6.0 m

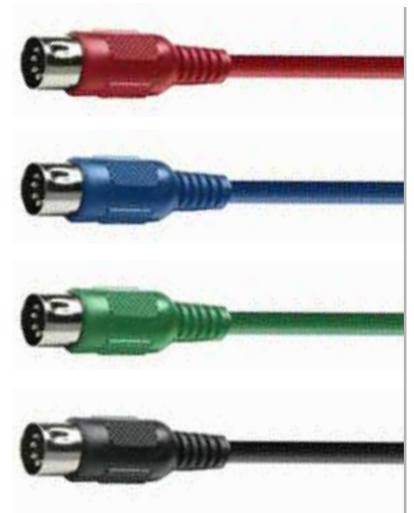



# DIGITAL AUDIO CABLES



TOSLINK is a standardized optical fibre connection system. Toslink optical cable is a fibre optical cable that carries digital audio data in the form of light pulses, rather than using electricity. Using these light pulses has the advantage that you can eliminate some of the distortions caused by imperfections of inductance, capacitance and resistance in some copper based cables. An optical cable is virtually impervious to magnetic or electrical interference.

## SPECIFICATIONS

	K3DTOS2M	K3DTOS4M
Type:	digital TOSLink audio cable	digital TOSLink audio cable
Cable colour:	black	black
Cable diameter:	2.2 mm	4.0 mm
Connector 1:	TOSLink (F05)	TOSLink (F05)
Connector 2:	TOSLink (F05)	TOSLink (F05)

### K3DTOS2M AUDIO CABLE

TOSLINK TO TOSLINK 2.2 MM Ø 0,5 M

Item No.	Length	CONNECTORS:
K3DTOS2M0050	0.5 m	▪ Custom-made
K3DTOS2M0100	1.0 m	▪ Custom-made
K3DTOS2M0200	2.0 m	
K3DTOS2M0500	5.0 m	
K3DTOS2M1000	10.0 m	



### K3DTOS4M AUDIO CABLE

TOSLINK TO TOSLINK 4 MM Ø 0,5 M

Item No.	Length	CONNECTORS:
K3DTOS4M0050	0.5 m	▪ Custom-made
K3DTOS4M0100	1.0 m	▪ Custom-made
K3DTOS4M0200	2.0 m	
K3DTOS4M0500	5.0 m	
K3DTOS4M1000	10.0 m	



## MULTICORE CABLES

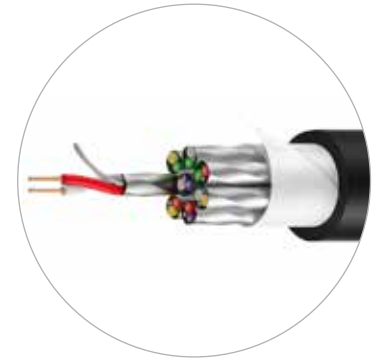

### SPECIFICATIONS

	K3L8CC	K3L8FV	K3L8MF	K3L8PC	K3L8PP	K3L8VP	K3L8VV
Type:	multicore	multicore	multicore	multicore	multicore	multicore	multicore
Channels:	8	8	8	8	8	4	8
Colour:	black	black	black	black	black	black	black
Cable diameter:	12.8 mm	12.8 mm	12.8 mm	12.8 mm	12.8 mm	12.8 mm	12.8 mm
Center conductor cross section:	0.23 mm <sup>2</sup>	0.23 mm <sup>2</sup>	0.23 mm <sup>2</sup>	0.23 mm <sup>2</sup>	0.23 mm <sup>2</sup>	0.23 mm <sup>2</sup>	0.23 mm <sup>2</sup>
Connector 1:	RCA	XLR	XLR	6.3 mm Jack	6.3 mm Jack	6.3 mm Jack	6.3 mm Jack
Connector 2:	RCA	6.3 mm Jack	6.3 mm Jack	RCA	6.3 mm Jack	6.3 mm Jack	6.3 mm Jack

### K3L8CC MULTICORE CABLE

8 X RCA MALE TO 8 X RCA MALE

Item No.	Length
K3L8CC0300	3.0 m
K3L8CC0500	5.0 m

### K3L8FV MULTICORE CABLE

8 X XLR FEMALE TO 8 X 6.3 MM JACK STEREO

Item No.	Length
K3L8FV0300	3.0 m
K3L8FV0500	5.0 m

### K3L8MF MULTICORE CABLE

8 X XLR MALE TO 8 X XLR FEMALE

Item No.	Length
K3L8MF0300	3.0 m
K3L8MF0500	5.0 m



# MULTICORE CABLES

## K3L8MV MULTICORE CABLE

8 X XLR MALE TO 8 X 6.3 MM JACK STEREO

Item No.	Length
K3L8MV0300	3.0 m
K3L8MV0500	5.0 m

## K3L8PC MULTICORE CABLE

8 X 6.3 MM JACK MONO TO 8 X RCA MALE

Item No.	Length
K3L8PC0300	3.0 m
K3L8PC0500	5.0 m

## K3L8PP MULTICORE CABLE

8 X 6.3 MM JACK MONO TO 8 X 6.3 MM JACK MONO

Item No.	Length
K3L8PP0300	3.0 m
K3L8PP0500	5.0 m

## K3L8VP MULTICORE CABLE

4 X 6.3 MM JACK STEREO TO 8 X 6.3 MM JACK MONO

Item No.	Length
K3L8VP0300	3.0 m
K3L8VP0500	5.0 m

## K3L8VV MULTICORE CABLE

8 X 6.3 MM JACK STEREO TO 8 X 6.3 MM JACK STEREO

Item No.	Length
K3L8VV0300	3.0 m
K3L8VV0500	5.0 m

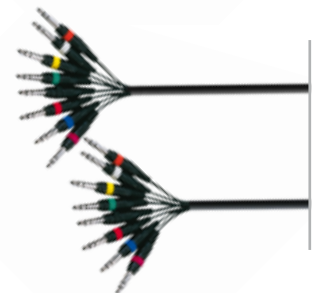
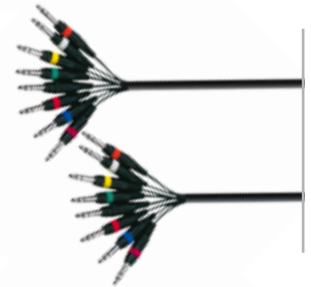
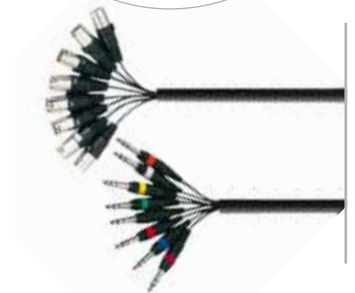
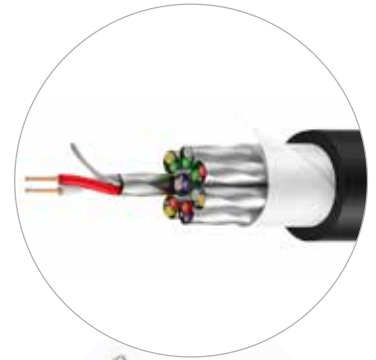

## DMX - AES/EBU CABLE DRUMS

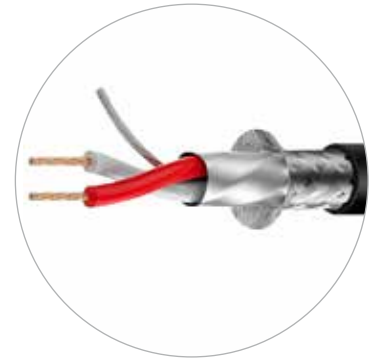

This rugged cable reel features 30 m flexible PVC-jacketed 110 ohm AES/EBU & DMX cable with a copper braid shield and high-quality 3-Pin and 5-PIN XLR connectors.

### FEATURES

- Cable drum with DMX AES/EBU compliant 110 ohm cable
- High-quality 3-Pin and 5-PIN AH connectors

### SPECIFICATIONS

Product type:	AES / EBU & DMX Cable
Colour:	black
Overall diameter:	5.8 mm +/- 0.2 mm
Jacket material:	PVC
AWG:	24
cross section:	0.22 mm <sup>2</sup>
Insulation:	PE 1,7 mm
Composition of conductor:	28 x 0.10 mm, bare cooper, OFC
Number of inner conductors:	2
Shielding:	tin plated copper braided shielding with 64 x 0.10mm + AL/PT-Foil + PE filler

Conductor resistance:	53 Ω/km
Capacitance Cond./Cond.:	< 68 pF/m
Capacitance Cond./Shield.:	45pF
Insulation Resistance:	>5 GΩ x km
Working Temperature:	-20° to +70°
Surge Impedance:	110 ohm

### K3CDDMX3030 3-PIN DMX/AES 30 M



### K3CDDMX5030 5-PIN DMX/AES 30 M



# MULTICORE CABLE DRUMS

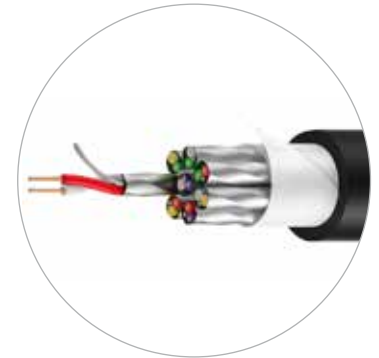

This 3-Star series audio snake features shielded multicore cable with a hardwearing PVC jacket and individually shielded pairs on a compact cable drum with integrated connector panel. The Splice and reel panel come with high quality 3-pin AH Connectors.

## FEATURES

- Cable drum with integrated Stage Box
- Equipped with high quality 3-Pin AH Connectors
- Overall and individually wire shielding

## SPECIFICATIONS

Product type:	Multicore Audio Cable
Colour:	black
Overall diameter:	14 mm +/- 0.2 mm
Jacket material:	PVS
AWG:	26
cross section:	0.14 mm <sup>2</sup>
Insulation:	PE 1,1 mm
Composition of conductor:	18 x 0.10 mm, bare cooper
Number of inner conductors:	8 x 2
Shielding:	AL/PT-foil + drain wire with 7 x 0.18mm tin plated copper

Conductor resistance:	127 Ω/km
Capacitance Cond./Cond.:	52 pF/m
Capacitance Cond./Shield.:	89 pF/m
Insulation Resistance:	> 1 GΩ
Working Temperature:	-20° to +70°
Surge Impedance:	100 ohm

### K3CDMC6215

3-STAR 15 M 6/2-CHANNEL AUDIO SNAKE REEL



### K3CDMC8015

3-STAR 15 M 8/0-CHANNEL AUDIO SNAKE REEL



## CAT5E CABLE DRUM

This EtherSound compatible 30 m CAT5e cable drum uses highly flexible, rugged CAT5e cable. It features a professional RJ 45 connector with removable die-cast shell enabling connection to standard RJ45 sockets. The cable has a flame-retardant TPU jacket

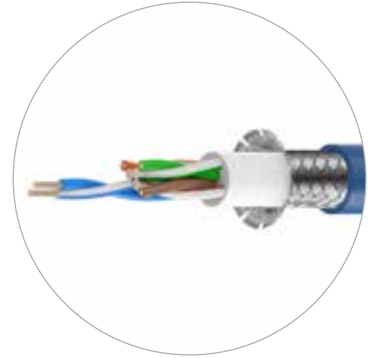

### FEATURES

- Cable drum with High-flexibility LSZH CAT5e cable Professional RJ 45 cable AH connector (D-Type) Removable connector shell enables plugging into standard RJ45 socket Cable length 30m
- Ethersound compliant

### SPECIFICATIONS

Product type:	CAT5e data cable
Colour:	blue
Overall diameter:	6.4 mm +/- 0.2 mm
Jacket material:	TPU
AWG:	26
cross section:	0.15 mm <sup>2</sup>
Insulation:	HDPE
Composition of conductor:	19 x 0.10 mm, bare cooper, OFC
Number of inner conductors:	4x2
Shielding:	tin plated copper braided shielding with 128 x 0.10mm

Conductor resistance:	< 85 Ω/km
Capacitance Cond./Cond.:	60 pF/m
Capacitance Cond./Shield.:	110 pF/m
Insulation Resistance:	> 10 GΩ
Working Temperature:	-40° to +85°
Surge Impedance:	100 ohm

### K3CDCAT5030

CABLE DRUM WITH CAT 5E ETHERNET CABLE 30 M





# “THERE ARE NO PROBLEMS, **ONLY SOLUTIONS!**”

- John Lennon.



**PRESS PATCH BOX 20**  
Press Patch Box 20-channel



**MONICON L**  
Passive Monitor Controller



**AHMCTXL**  
Cable Tester



**PLI 02**  
Line Isolation Box 2 Channel



**PAN 01 PRO**  
Professional DI Box passive



**PLI 04 USB**  
2-Channel USB DI Box and Line Isolator



Starting out as a custom amp and mod shop Palmer has become one of the best known secrets in the music industry. Taking care of their individual needs the close cooperation with local musicians provided valuable insight and hands-on knowledge resulting in highly specialized gear and product improvements unavailable elsewhere.

The professional demands of stage and studio led to the development of the Pro Audio line of equipment. Designed for maximum signal integrity, reliability and intuitive operation it features common usage devices as well as sophisticated units to facilitate more specific sound reinforcement, installation and recording applications. Browse the Palmer Pro Audio product categories for the tools that make a sound guy's job so much easier and much more fun.

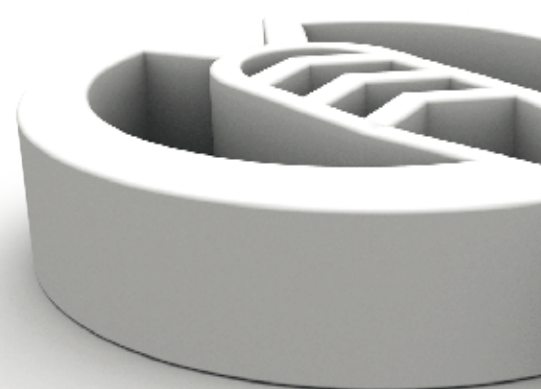





## CONNECTORS & ADAPTERS

Our selection of connectors comprises all major formats including XLR cable and chassis connectors, straight and right-angle  $\frac{1}{4}$ " plugs, RCA, BNC and speaker cable connectors plus a wide range of adapters.

# CONNECTORS



**7510**  
6.3 MM JACK PLUG MONO GOLD

#### SPECIFICATIONS

Product type:	jack
Type:	6.3 mm
Poles:	2
Gender:	male
Cable diameter:	5 mm - 6.5 mm
Contacts:	gold plated
Connection type:	solder contacts
Colour:	silver
Housing:	steel
Strain relief:	metal
Dimensions (Lx Ø):	80 mm x 12.5 mm



**7511**  
6.3 MM JACK PLUG STEREO GOLD

#### SPECIFICATIONS

Product type:	jack
Type:	6.3 mm
Poles:	3
Gender:	male
Cable diameter:	5 mm - 6.5 mm
Contacts:	gold plated
Connection type:	solder contacts
Colour:	silver
Housing:	steel
Strain relief:	metal
Dimensions (Lx Ø):	80 mm x 12.5 mm



**7514**  
6.3 MM JACK PLUG MONO

#### SPECIFICATIONS

Product type:	jack
Type:	6.3 mm
Poles:	3
Gender:	male
Cable diameter:	5 mm - 6.5 mm
Contacts:	nickel-silver
Connection type:	solder contacts
Colour:	silver
Housing:	steel
Strain relief:	metal
Dimensions (Lx Ø):	80 mm x 13 mm



**7515**  
6.3 MM JACK PLUG STEREO

#### SPECIFICATIONS

Product type:	jack
Type:	6.3 mm
Poles:	3
Gender:	male
Cable diameter:	5 mm - 6.5 mm
Contacts:	nickel-silver
Connection type:	solder contacts
Colour:	silver
Housing:	steel
Strain relief:	metal
Dimensions (Lx Ø):	80 mm x 13 mm



**7516**  
6.3 MM JACK PLUG MONO

#### SPECIFICATIONS

Product type:	jack
Type:	6.3 mm
Poles:	2
Gender:	male
Cable diameter:	3.2 mm - 7 mm
Contacts:	nickel-silver
Connection type:	solder contacts
Colour:	silver
Housing:	steel
Strain relief:	metal
Dimensions (Lx Ø):	83 mm x 12 mm



**7520**  
6.3 MM JACK PLUG STEREO CHROME

#### SPECIFICATIONS

Product type:	jack
Type:	6.3 mm
Poles:	3
Gender:	male
Cable diameter:	3.2 mm - 7 mm
Contacts:	nickel-silver
Connection type:	solder contacts
Colour:	silver
Housing:	steel
Strain relief:	metal
Dimensions (Lx Ø):	83 mm x 12 mm

# CONNECTORS



## 7523

6.3 MM JACK PLUG MONO WITH GOLD TIP

### SPECIFICATIONS

Product type:	jack
Type:	6.3 mm
Poles:	2
Gender:	male
Cable diameter:	5 mm - 6 mm
Contacts:	nickel-silver / gold (tip)
Connection type:	solder contacts
Colour:	silver
Housing:	die-cast zinc
Strain relief:	plastic
Dimensions (Lx Ø):	95 mm x 16 mm



## 7524

6.3 MM JACK PLUG STEREO WITH GOLD TIP

### SPECIFICATIONS

Product type:	jack
Type:	6.3 mm
Poles:	3
Gender:	male
Cable diameter:	5 mm - 6 mm
Contacts:	nickel-silver / gold (tip)
Connection type:	solder contacts
Colour:	silver
Housing:	die-cast zinc
Strain relief:	plastic
Dimensions (Lx Ø):	95 mm x 16 mm



## 75192

ANGLED 6.3 MM JACK PLUG MONO

### SPECIFICATIONS

Product type:	Angled Jack Plug
Type:	6.3 mm
Poles:	2
Gender:	male
Cable diameter:	5 mm - 7 mm
Contacts:	nickel-silver
Connection type:	solder contacts
Colour:	silver
Housing:	steel
Strain relief:	metal
Dimensions (Lx Ø):	44 mm x 12 mm



## 7525

ANGLED 6.3 MM JACK PLUG MONO FLAT

### SPECIFICATIONS

Product type:	Angled Jack Plug
Type:	mono
Poles:	2
Gender:	male
Cable diameter:	4 mm - 7 mm
Contacts:	gold plated
Connection type:	solder contacts
Colour:	black, silver
Housing:	die-cast zinc
Dimensions (W x H x D):	40.4 mm x 33.8 mm x 20.7 mm



## 7896

LOCKABLE 6.3 MM STEREO CABLE JACK SOCKET CONNECTOR

### SPECIFICATIONS

Product Type:	stereo cable jack socket connector
No. of Poles:	3
Connector Gender:	female
Cable Diameter:	5-7 mm
Contacts:	silver-plated
Connector Type:	solder cups
Housing:	nickel-plated zinc alloy
Type of Closure:	latch lock with quick release tab



## 7557

3.5 MM JACK PLUG STEREO

### SPECIFICATIONS

Product type:	Jack
Type:	3.5 mm
Poles:	3
Gender:	male
Cable diameter:	5 mm - 6 mm
Contacts:	nickel-silver
Connection type:	solder contacts
Colour:	silver
Housing:	steel
Strain relief:	metal
Dimensions (Lx Ø):	51 mm x 12.5 mm



# CONNECTORS



**7624**  
3.5 MM STEREO JACK PLUG

### SPECIFICATIONS

Product type:	Jack
Type:	3.5 mm
Poles:	3
Gender:	male
Cable diameter:	5 mm - 6 mm
Contacts:	nickel-silver
Connection type:	solder contacts
Colour:	silver
Housing:	steel
Strain relief:	metal
Dimensions (Lx Ø):	52 mm x 13 mm



**7625**  
3.5 MM STEREO JACK PLUG

### SPECIFICATIONS

Product type:	Jack
Type:	3.5 mm
Poles:	3
Gender:	male
Cable diameter:	3 mm - 4 mm
Contacts:	nickel-silver
Connection type:	solder contacts
Colour:	silver
Housing:	steel
Strain relief:	metal
Dimensions (Lx Ø):	58 mm x 10 mm



**7620BLK**  
RCA PLUG BLACK

### SPECIFICATIONS

Product type:	RCA plug
Type:	audio
Poles:	2
Gender:	male
Cable diameter:	5 mm - 6 mm
Colour marker:	black
Contacts:	gold plated
Connection type:	solder contacts
Colour:	silver
Housing:	aluminum
Strain relief:	metal
Dimensions (Lx Ø):	46 mm x 12 mm



**7620RED**  
RCA PLUG RED

### SPECIFICATIONS

Product type:	RCA plug
Type:	audio
Poles:	2
Gender:	male
Cable diameter:	5 mm - 6 mm
Colour marker:	red
Contacts:	gold plated
Connection type:	solder contacts
Colour:	silver
Housing:	aluminum
Strain relief:	metal
Dimensions (Lx Ø):	46 mm x 12 mm



**7622BLK**  
RCA PLUG BLACK

### SPECIFICATIONS

Product type:	RCA plug
Type:	audio
Poles:	2
Gender:	male
Cable diameter:	4 mm - 7 mm
Colour marker:	black
Contacts:	chromium plated
Connection type:	solder contacts
Colour:	silver
Housing:	steel
Strain relief:	metal
Dimensions (Lx Ø):	60 mm x 12 mm



**7622RED**  
RCA PLUG RED

### SPECIFICATIONS

Product type:	RCA plug
Type:	audio
Poles:	2
Gender:	male
Cable diameter:	4 mm - 7 mm
Colour marker:	red
Contacts:	chromium plated
Connection type:	solder contacts
Colour:	silver
Housing:	steel
Strain relief:	metal
Dimensions (Lx Ø):	60 mm x 12 mm



# CONNECTORS



## 7623BLK

RCA PLUG GOLD-PLATED BLACK

### SPECIFICATIONS

Product type:	RCA plug
Type:	audio
Poles:	2
Gender:	male
Cable diameter:	4 mm - 7 mm
Colour marker:	black
Contacts:	gold plated
Connection type:	solder contacts
Colour:	gold
Housing:	steel
Strain relief:	metal
Dimensions (Lx Ø):	60 mm x 12 mm



## 7623RED

RCA PLUG GOLD-PLATED RED

### SPECIFICATIONS

Product type:	Jack
Type:	3.5 mm
Poles:	3
Gender:	male
Cable diameter:	5 mm - 6 mm
Contacts:	nickel-silver
Connection type:	solder contacts
Colour:	silver
Housing:	steel
Strain relief:	metal
Dimensions (Lx Ø):	51 mm x 12.5 mm



## 7635BLK

RCA SOCKET GOLD-PLATED BLACK

### SPECIFICATIONS

Product type:	RCA Socket
Poles:	2
Gender:	female
Colour marker:	black
Contacts:	gold plated
Connection type:	solder contacts
Housing:	without housing
Dimensions (W x H x D):	15 mm x 15 mm x 27 mm



## 7635RED

RCA SOCKET GOLD-PLATED RED

### SPECIFICATIONS

Product type:	RCA Socket
Poles:	2
Gender:	female
Colour marker:	red
Contacts:	gold plated
Connection type:	solder contacts
Housing:	without housing
Dimensions (W x H x D):	15 mm x 15 mm x 27 mm

NEW!



## 7887

RJ45 CAT.5E MALE

### SPECIFICATIONS

Product type:	RJ-45 PLUG
Type:	RJ45 CAT.5e
Poles:	8
Gender:	male
Cable diameter:	max 6.6mm
Contacts:	gold plated
Connection type:	crimp
Colour:	black
Housing:	Metal, Plastic
Strain relief:	metal
Dimensions (Lx Ø):	50,5 mm x 17,3 mm

NEW!



## 7897

RJ45 XLR SHELL

### SPECIFICATIONS

Product type:	XLR connector
Type:	metal shell for RJ45
Gender:	male
Cable diameter:	5 mm - 7 mm
Colour:	silver
Housing:	die-cast zinc
Dimensions (Lx Ø):	67 mm x 19 mm

# CONNECTORS



**7847**  
XLR PLUG FEMALE

### SPECIFICATIONS

Product type:	XLR Connector
Type:	audio
Poles:	3
Gender:	female
Cable diameter:	5 mm - 7 mm
Contacts:	silver plated
Connection type:	solder contacts
Colour:	silver
Housing:	die-cast zinc
Strain relief:	plastic
Dimensions (L x Ø):	70 mm x 18 mm



**7898**  
XLR PLUG FEMALE SILVER

### SPECIFICATIONS

Product type:	XLR Plug
Type:	audio
Poles:	3
Gender:	female
Cable diameter:	5 - 7mm
Contacts:	Silver plated
Connection type:	Solder contact
Colour:	silver
Housing:	die-case zinc
Strain-relief:	plastic
Dimensions (L x Ø):	70,0 x 19,3 mm



**7899**  
XLR PLUG MALE SILVER

### SPECIFICATIONS

Product type:	XLR Plug
Type:	audio
Poles:	3
Gender:	male
Cable diameter:	5 - 7mm
Contacts:	Silver plated
Connection type:	Solder contact
Colour:	silver
Housing:	die-case zinc
Strain-relief:	plastic
Dimensions (L x Ø):	67,0 x 19,3 mm



**7848**  
XLR PLUG MALE

### SPECIFICATIONS

Product type:	XLR Connector
Type:	audio
Poles:	3
Gender:	male
Cable diameter:	5 mm - 7 mm
Contacts:	silver plated
Connection type:	solder contacts
Colour:	silver
Housing:	die-cast zinc
Strain relief:	plastic
Dimensions (L x Ø):	68 mm x 18 mm



**7849**  
XLR PLUG FEMALE BLACK

### SPECIFICATIONS

Product type:	XLR Connector
Type:	audio
Poles:	3
Gender:	female
Cable diameter:	5 mm - 7 mm
Contacts:	silver plated
Connection type:	solder contacts
Colour:	black
Housing:	die-cast zinc
Strain relief:	plastic
Dimensions (L x Ø):	70 mm x 19 mm



**7850**  
XLR PLUG MALE BLACK

### SPECIFICATIONS

Product type:	XLR Connector
Type:	audio
Poles:	3
Gender:	male
Cable diameter:	5 mm - 7 mm
Contacts:	silver plated
Connection type:	solder contacts
Colour:	black
Housing:	die-cast zinc
Strain relief:	plastic
Dimensions (L x Ø):	67 mm x 19 mm

# CONNECTORS



**7885**  
XLR PLUG FEMALE 5-POL BLACK

### SPECIFICATIONS

Product type:	XLR connector
Type:	audio / DMX
Poles:	5
Gender:	female
Cable diameter:	4 mm - 6,5 mm
Contacts:	silver plated
Connection type:	solder contacts
Colour:	black
Housing:	die-cast zinc
Dimensions (L x Ø):	70 mm x 19.3 mm



**7886**  
XLR PLUG MALE 5-POL BLACK

### SPECIFICATIONS

Product type:	XLR connector
Type:	audio / DMX
Poles:	5
Gender:	male
Cable diameter:	4 mm - 6,5 mm
Contacts:	silver plated
Connection type:	solder contacts
Colour:	black
Housing:	die-cast zinc
Dimensions (L x Ø):	67 mm x 19.3 mm

NEW!



**7889**  
XLR CABLE CONNECTOR 3-POLE FEMALE IP65

### SPECIFICATIONS

Product Category:	connector
Type:	XLR
Poles:	3
Gender:	female
Cable Diameter:	3.5 - 8mm
Contacts:	gold plated
Wiring:	solder contacts
Colour:	silver, black + orange
Shell:	diecast zinc
Dimensions (L x Ø):	73.6 mm x 16.8 mm

NEW!



**7888**  
XLR CABLE CONNECTOR 3-PIN MALE IP65

### SPECIFICATIONS

Product Category:	connector
Type:	XLR
Poles:	3
Gender:	male
Cable Diameter:	3.5 - 8 mm
Contacts:	gold plated
Wiring:	solder contacts
Colour:	silver, black orange
Shell:	diecast zinc
Dimensions (L x Ø):	70.8 mm x 18.9 mm

NEW!



**7890**  
XLR CABLE CONNECTOR 5-POLE FEMALE IP65

### SPECIFICATIONS

Product Category:	connector
Type:	XLR
Poles:	5
Gender:	female
Cable Diameter:	3.5 - 8mm
Contacts:	gold plated
Wiring:	solder contacts
Colour:	silver, black + orange
Housing:	diecast zinc
Dimensions (L x Ø):	73.6 mm x 16.8 mm

NEW!



**7891**  
XLR CABLE CONNECTOR 5-PIN MALE IP65

### SPECIFICATIONS

Product Category:	connector
Type:	XLR
Poles:	5
Gender:	male
Cable Diameter:	3.5 - 8mm
Contacts:	gold plated
Wiring:	solder contacts
Colour:	silver, black + orange
Shell:	diecast zinc
Dimensions (L x Ø):	70.8 mm x 18.9 mm

# CONNECTORS



## K3DMXT3

DMX TERMINATOR 3-POLE 120 OHMS

### SPECIFICATIONS

Product type:	XLR connector
Type:	DMX
Poles:	3
Gender:	male
Contacts:	gold plated
Connection type:	solder contacts
Colour:	black
Housing:	die-cast zinc
Strain relief:	plastic
Dimensions (Lx Ø):	77 mm x 20 mm
Additional information:	with 120-ohm terminator



## K3DMXT5

DMX TERMINATOR 5-POLE 120 OHMS

### SPECIFICATIONS

Product type:	XLR connector
Type:	DMX
Poles:	5
Gender:	male
Contacts:	gold-plated
Connection type:	solder contacts
Colour:	black
Housing:	die-cast zinc
Strain relief:	plastic
Dimensions (Lx Ø):	77 mm x 20 mm
Additional information:	with 120-ohm terminator



## 7837

CHASSIS CONNECTOR XLR FEMALE D-TYPE

### SPECIFICATIONS

Product type:	XLR Socket
Poles:	3
Gender:	female
Contacts:	silver plated
Connection type:	solder contacts
Housing:	die-cast zinc
Dimensions (W x H x D):	26 mm x 31 mm x 27 mm
Additional information:	D-size body
Housing:	steel
Strain relief:	metal
Dimensions (Lx Ø):	51 mm x 12.5 mm



## 7838

CHASSIS CONNECTOR XLR MALE D-TYPE

### SPECIFICATIONS

Product type:	XLR Socket
Poles:	3
Gender:	male
Contacts:	silver plated
Connection type:	solder contacts
Housing:	die-cast zinc
Dimensions (W x H x D):	26 mm x 31 mm x 25 mm
Additional information:	D-size body



## 7892

XLR CHASSIS CONNECTOR 5-PIN MALE D-TYPE

### SPECIFICATIONS

Product Type:	XLR chassis connector 5-pin male D-Type
No. of Poles:	5
Connector Gender:	female
Contacts:	silver-plated
Connector Type:	solder / plug-type contact
Housing:	nickel-plated zinc alloy
Dimensions (W x H x D):	26 mm x 31 mm x 34 mm



## 7893

XLR CHASSIS CONNECTOR 5-PIN MALE D-TYPE

### SPECIFICATIONS

Product Type:	XLR chassis connector 5-pin male, D-Type
No. of Poles:	5
Connector Gender:	male
Contacts:	silver-plated
Connector Type:	solder / plug-type contact
Housing:	nickel-plated zinc alloy
Dimensions (W x H x D):	26 mm x 31 mm x 34 mm

# CONNECTORS



**7871**  
STANDARD SPEAKER CONNECTOR 4-POLE

### SPECIFICATIONS

Product type:	loudspeaker connectors
Type:	Standard Speaker Connector
Poles:	4
Gender:	female
Cable diameter:	5 mm - 11 mm
Contacts:	silver plated
Connection type:	screw contact
Colour:	black
Housing:	polyamide
Strain relief:	polyacetal
Dimensions (Lx Ø):	70 mm x 27 mm



**7874**  
STANDARD SPEAKER CONNECTOR 4-POLE

### SPECIFICATIONS

Product type:	loudspeaker connectors
Type:	Standard Speaker Connector
Poles:	4
Gender:	male
Cable diameter:	6 mm - 12 mm
Contacts:	nickel plated
Connection type:	solder contacts
Colour:	blue / black
Housing:	polyamid
Strain relief:	polyacetal
Dimensions (Lx Ø):	91.25 mm x 27.85 mm



**7884**  
STANDARD SPEAKER CONNECTOR 4-POLE

### SPECIFICATIONS

Product type:	loudspeaker connectors
Type:	Standard Speaker Connector
Poles:	4
Gender:	female
Cable diameter:	5mm - 11 mm
Contacts:	silver plated
Connection type:	screws / solder contacts
Colour:	black
Housing:	polyamide
Strain relief:	polyacetal
Dimensions (Lx Ø):	70.8 mm x 26.1 mm



**7875**  
STANDARD SPEAKER CONNECTOR CHASSIS 4-POLE

### SPECIFICATIONS

Product type:	Standard Speaker Connector Chassis
Poles:	4
Gender:	female
Contacts:	silver plated
Connection type:	solder / plug-type contact
Housing:	plastic
Dimensions (W x H x D):	26 mm x 31 mm x 33 mm
Additional information:	metal front plate



**7876**  
STANDARD SPEAKER CONNECTOR CHASSIS 4-POLE

### SPECIFICATIONS

Product type:	Standard Speaker Connector Chassis
Poles:	4
Gender:	female
Contacts:	silver plated
Connection type:	solder / plug-type contact
Housing:	plastic
Dimensions (W x H x D):	26 mm x 31 mm x 33 mm



**KCVCD70**  
BNC SOCKET DOUBLE FEMALE D-TYPE, 75 OHMS

### SPECIFICATIONS

Product type:	BNC Socket
Type:	double female
Poles:	2
Gender:	female
Contacts:	chromium plated
Connection type:	BNC
Housing:	die-cast zinc
Dimensions (W x H x D):	26 mm x 31 mm x 37 mm
Additional information:	in D-type housing

# CONNECTORS



## KCVCD72

BNC SOCKET FEMALE D-TYPE

### SPECIFICATIONS

Product type:	BNC Socket
Poles:	2
Gender:	female
Contacts:	chromium plated
Connection type:	solder contacts
Housing:	die-cast zinc
Dimensions (W x H x D):	26 mm x 31 mm x 28 mm
Additional information:	in D-type housing



## 8101P

IECC POWER PLUG FEMALE

### SPECIFICATIONS

Product type:	IECC plug connector
Type:	Connector
Poles:	3
Gender:	female
Max. current:	6
Cabinet material:	plastic
Colour:	black



## 8102C

IECC POWER PLUG MALE

### SPECIFICATIONS

Product type:	IECC plug connector
Type:	Connector
Poles:	3
Gender:	male
Max. current:	6
Cabinet material:	plastic
Colour:	black



## 8101S

IECC POWER SOCKET MALE

### SPECIFICATIONS

Product type:	IECC plug connector
Type:	Chassis connector
Poles:	3
Gender:	male
Max. current:	6
Cabinet material:	plastic
Colour:	black
Housing:	metal

# ADAPTERS



## 7861

ADAPTER XLR MALE TO XLR MALE

### SPECIFICATIONS

Product type:	Audio Adapter
Connector 1:	XLR
Gender of connector 1:	male
Poles of connector 1:	3
Connector 2:	XLR
Gender of connector 2:	male
Poles of connector 2:	3
Housing:	metal



## 7860

ADAPTER XLR FEMALE TO XLR FEMALE

### SPECIFICATIONS

Product type:	Audio Adapter
Connector 1:	XLR
Gender of connector 1:	female
Poles of connector 1:	3
Connector 2:	XLR
Gender of connector 2:	female
Poles of connector 2:	3
Housing:	metal
Colour:	silver
Housing:	aluminum
Strain relief:	metal
Dimensions (Lx Ø):	46 mm x 12 mm



## 7870

ADAPTER 3-POLE XLR MALE TO 5-POLE XLR FEMALE

### SPECIFICATIONS

Product type:	DMX Adapter
Connector 1:	XLR
Gender of connector 1:	male
Poles of connector 1:	3
Connector 2:	XLR
Gender of connector 2:	female
Poles of connector 2:	5
Housing:	metal



## 7869

ADAPTER 3-POLE XLR FEMALE TO 5-POLE XLR MALE

### SPECIFICATIONS

Product type:	DMX Adapter
Connector 1:	XLR
Gender of connector 1:	female
Poles of connector 1:	3
Connector 2:	XLR
Gender of connector 2:	male
Poles of connector 2:	5
Housing:	metal



## 7853

ADAPTER 6.3 MM JACK STEREO FEMALE TO XLR MALE

### SPECIFICATIONS

Product type:	Audio Adapter
Connector 1:	XLR
Gender of connector 1:	male
Poles of connector 1:	3
Connector 2:	6.3 mm Jack
Gender of connector 2:	female
Poles of connector 2:	3
Housing:	metal



## 7854

ADAPTER 6.3 MM JACK STEREO FEMALE TO XLR FEMALE

### SPECIFICATIONS

Product type:	Audio Adapter
Connector 1:	XLR
Gender of connector 1:	female
Poles of connector 1:	3
Connector 2:	6.3 mm Jack
Gender of connector 2:	female
Poles of connector 2:	3
Housing:	metal



# ADAPTERS



## 7872

ADAPTER XLR MALE TO JACK  
MONO MALE

### SPECIFICATIONS

Product type:	Audio Adapter
Connector 1:	XLR
Gender of connector 1:	male
Poles of connector 1:	3
Connector 2:	6.3 mm Jack
Gender of connector 2:	male
Poles of connector 2:	2
Housing:	metal



## 7873

ADAPTER XLR FEMALE TO JACK  
MONO MALE

### SPECIFICATIONS

Product type:	Audio Adapter
Connector 1:	XLR
Gender of connector 1:	female
Poles of connector 1:	3
Connector 2:	6.3 mm Jack
Gender of connector 2:	male
Poles of connector 2:	2
Housing:	metal



## 7855

ADAPTER 6.3 MM JACK STEREO MALE  
TO XLR MALE

### SPECIFICATIONS

Product type:	Audio Adapter
Connector 1:	XLR
Gender of connector 1:	male
Poles of connector 1:	3
Connector 2:	6.3 mm Jack
Gender of connector 2:	male
Poles of connector 2:	3
Housing:	metal



## 7856

ADAPTER 6.3 MM JACK STEREO MALE TO  
XLR FEMALE

### SPECIFICATIONS

Product type:	Audio Adapter
Connector 1:	XLR
Gender of connector 1:	female
Poles of connector 1:	3
Connector 2:	6.3 mm Jack
Gender of connector 2:	male
Poles of connector 2:	3
Housing:	metal



## 7867

ADAPTER XLR MALE TO RCA MALE

### SPECIFICATIONS

Product type:	Audio Adapter
Connector 1:	XLR
Gender of connector 1:	male
Poles of connector 1:	3
Connector 2:	RCA
Gender of connector 2:	male
Poles of connector 2:	2
Housing:	metal



## 7868

ADAPTER XLR FEMALE TO RCA MALE

### SPECIFICATIONS

Product type:	Audio Adapter
Connector 1:	XLR
Gender of connector 1:	female
Poles of connector 1:	3
Connector 2:	RCA
Gender of connector 2:	male
Poles of connector 2:	2
Housing:	metal

# ADAPTERS



**7857**  
ADAPTER RCA FEMALE TO XLR MALE

### SPECIFICATIONS

Product type:	Audio Adapter
Connector 1:	XLR
Gender of connector 1:	male
Poles of connector 1:	3
Connector 2:	RCA
Gender of connector 2:	female
Poles of connector 2:	2
Housing:	metal



**7858**  
ADAPTER RCA FEMALE TO XLR FEMALE

### SPECIFICATIONS

Product type:	Audio Adapter
Connector 1:	XLR
Gender of connector 1:	female
Poles of connector 1:	3
Connector 2:	RCA
Gender of connector 2:	female
Poles of connector 2:	2
Housing:	metal



**7879**  
ADAPTER 6.3 MM STEREO JACK FEMALE TO 6.3 MM STEREO JACK FEMALE WITH LATCH LOCK

### SPECIFICATIONS

Product type:	Audio Adapter
Connector 1:	6.3 mm Jack
Gender of connector 1:	female
Connector 2:	6.3 mm Jack
Gender of connector 2:	female
Housing:	metal



**7880**  
ADAPTER STANDARD SPEAKER CONNECTOR CHASSIS 4-POLE TO STANDARD SPEAKER CONNECTOR CHASSIS 4-POLE

### SPECIFICATIONS

Product type:	Audio Adapter
Connector 1:	Standard Speaker Connector Chassis
Gender of connector 1:	female
Connector 2:	Standard Speaker Connector Chassis
Gender of connector 2:	female
Housing:	plastic



**7863**  
ADAPTER STANDARD SPEAKER CONNECTOR CHASSIS 4-POLE TO XLR FEMALE

### SPECIFICATIONS

Product type:	Audio Adapter
Connector 1:	Standard Speaker Connector Chassis
Gender of connector 1:	male
Poles of connector 1:	4
Connector 2:	XLR
Gender of connector 2:	female
Poles of connector 2:	3
Housing:	metal
Housing:	die-cast zinc
Strain relief:	plastic
Dimensions (Lx Ø):	70 mm x 18 mm



**7864**  
ADAPTER SPEAKON COMPATIBLE 4-POLE CHASSIS TO XLR MALE

### SPECIFICATIONS

Product type:	Audio Adapter
Connector 1:	Standard Speaker Connector Chassis
Gender of connector 1:	male
Poles of connector 1:	4
Connector 2:	XLR
Gender of connector 2:	male
Poles of connector 2:	3
Housing:	metal

# ADAPTERS



## 7865

ADAPTER STANDARD SPEAKER  
CONNECTOR 4-POLE TO XLR FEMALE

### SPECIFICATIONS

Product type:	Audio Adapter
Connector 1:	Standard Speaker Connector
Gender of connector 1:	female
Poles of connector 1:	4
Connector 2:	XLR
Gender of connector 2:	female
Poles of connector 2:	3
Housing:	metal



## 7866

ADAPTER STANDARD SPEAKER  
CONNECTOR 4-POLE TO XLR MALE

### SPECIFICATIONS

Product type:	Audio Adapter
Connector 1:	Standard Speaker Connector
Gender of connector 1:	female
Poles of connector 1:	4
Connector 2:	XLR
Gender of connector 2:	male
Poles of connector 2:	3
Housing:	metal



## 7882

ADAPTER 6.3 MM MONO JACK MALE  
TO 6.3 MM MONO JACK MALE, OFFSET

### SPECIFICATIONS

Product type:	Audio Adapter
Connector 1:	6.3 mm Jack
Gender of connector 1:	male
Poles of connector 1:	3
Connector 1:	6.3 mm Jack
Gender of connector 1:	male
Poles of connector 1:	3
Housing:	metal



## 7883

ADAPTER 6.3 MM MONO JACK MALE TO  
6.3 MM MONO JACK MALE, STRAIGHT

### SPECIFICATIONS

Product type:	Audio Adapter
Connector 1:	6.3 mm Jack
Gender of connector 1:	male
Poles of connector 1:	3
Connector 1:	6.3 mm Jack
Gender of connector 1:	male
Poles of connector 1:	3
Housing:	metal



## 7540

ADAPTER MONO RCA FEMALE TO 6.3 MM  
MONO JACK MALE

### SPECIFICATIONS

Product type:	Audio Adapter
Connector 1:	RCA
Gender of connector 1:	female
Poles of connector 1:	2
Connector 2:	6.3 mm Jack
Gender of connector 2:	male
Poles of connector 2:	2
Housing:	metal



## 7543G

ADAPTER 3.5 MM STEREO JACK FEMALE TO  
6.3 MM STEREO JACK MALE GOLD PLATED

### SPECIFICATIONS

Product type:	Audio Adapter
Connector 1:	3.5 mm Jack
Gender of connector 1:	female
Poles of connector 1:	3
Connector 2:	6.3 mm Jack
Gender of connector 2:	male
Poles of connector 2:	3
Housing:	gold plated

# ADAPTERS



## 7542

ADAPTER 3.5 MM MONO JACK FEMALE TO 6.3 MM MONO JACK

### SPECIFICATIONS

Connector 1:	6.3 mm Jack
Gender of connector 1:	male
Poles of connector 1:	2
Connector 2:	3.5 mm Jack
Gender of connector 2:	female
Poles of connector 2:	2
Housing:	plastic



## 7543

ADAPTER 3.5 MM STEREO JACK FEMALE TO 6.3 MM STEREO JACK

### SPECIFICATIONS

Product type:	Audio Adapter
Connector 1:	6.3 mm Jack
Gender of connector 1:	male
Poles of connector 1:	3
Connector 2:	3.5 mm Jack
Gender of connector 2:	female
Poles of connector 2:	3
Housing:	plastic



NEW!

## 7894

90° ANGLE ADAPTER 6.3 MM STEREO JACK MALE TO FEMALE

### SPECIFICATIONS

Product Type:	audio adapter
Connector 1:	6.3 mm plug gold-plated
Connector 1 Gender:	female
Connector 1 Number of Pins:	3
Connector 2:	6.3 mm plug gold-plated
Connector 2 Gender:	male
Connector 2 Number of Pins:	3
Housing:	plastic
Dimensions (W x H x D):	61 mm x 15.5 mm x 51 mm



## 7551

ADAPTER 6.3 MM STEREO JACK FEMALE TO 6.3 MM STEREO JACK

### SPECIFICATIONS

Product type:	Audio Adapter
Connector 1:	6.3 mm Jack
Gender of connector 1:	female
Poles of connector 1:	3
Connector 2:	6.3 mm Jack
Gender of connector 2:	female
Poles of connector 2:	3
Housing:	plastic



## 7547

Y-ADAPTER 2 X 6.3 MM MONO JACK FEMALE TO 6.3 MM MONO JACK

### SPECIFICATIONS

Product type:	Audio Adapter
Type:	Y-Adapter
Connector 1:	6.3 mm Jack
Gender of connector 1:	male
Poles of connector 1:	2
Connector 2:	6.3 mm Jack
Gender of connector 2:	female
Poles of connector 2:	2
Housing:	plastic



## 7546

Y-ADAPTER 2 X 6.3 MM STEREO JACK FEMALE TO 6.3 MM STEREO

### SPECIFICATIONS

Product type:	Audio Adapter
Type:	Y-Adapter
Connector 1:	6.3 mm Jack
Gender of connector 1:	male
Poles of connector 1:	3
Connector 2:	6.3 mm Jack
Gender of connector 2:	female
Poles of connector 2:	3
Housing:	plastic

# ADAPTERS



## 7548

Y-ADAPTER 2 X MONO RCA FEMALE  
TO 6.3 MM MONO JACK MALE

### SPECIFICATIONS

Product type:	Audio Adapter
Type:	Y-Adapter
Connector 1:	6.3 mm Jack
Gender of connector 1:	male
Poles of connector 1:	2
Connector 2:	RCA
Gender of connector 2:	female
Poles of connector 2:	2
Housing:	plastic



## 7549

Y-ADAPTER 2 X MONO RCA FEMALE TO  
6.3 MM STEREO JACK MALE

### SPECIFICATIONS

Product type:	Audio Adapter
Type:	Y-Adapter
Connector 1:	6.3 mm Jack
Gender of connector 1:	male
Poles of connector 1:	3
Connector 2:	RCA
Gender of connector 2:	female
Poles of connector 2:	2
Housing:	plastic



## 7554

ADAPTER 6.3 MM MONO JACK FEMALE  
TO 3.5 MM MONO JACK

### SPECIFICATIONS

Product type:	Audio Adapter
Connector 1:	3.5 mm Jack
Gender of connector 1:	male
Poles of connector 1:	2
Connector 2:	6.3 mm Jack
Gender of connector 2:	female
Poles of connector 2:	2
Housing:	plastic



## 7555

ADAPTER 3.5 MM STEREO JACK FEMALE  
TO 3.5 MM MONO JACK

### SPECIFICATIONS

Product type:	Audio Adapter
Connector 1:	3.5 mm Jack
Gender of connector 1:	male
Poles of connector 1:	2
Connector 2:	3.5 mm Jack
Gender of connector 2:	female
Poles of connector 2:	3
Housing:	plastic



## 7556

Y-ADAPTER 2 X STEREO JACK 3.5 MM  
FEMALE TO STEREO JACK 3.5 MM MALE

### SPECIFICATIONS

Product type:	Audio Adapter
Type:	Y-Adapter
Connector 1:	3.5 mm Jack
Gender of connector 1:	male
Poles of connector 1:	3
Connector 2:	3.5 mm Jack
Gender of connector 2:	female
Poles of connector 2:	3
Housing:	plastic



## 7550

Y-ADAPTER 2 X MONO RCA FEMALE  
TO 3.5 MM STEREO JACK MALE

### SPECIFICATIONS

Product type:	Audio Adapter
Type:	Y-Adapter
Connector 1:	3.5 mm Jack
Gender of connector 1:	male
Poles of connector 1:	3
Connector 2:	RCA
Gender of connector 2:	female
Poles of connector 2:	2
Housing:	plastic

# ADAPTERS



## 7552

ADAPTER 2 X MONO RCA FEMALE TO 2 X MONO RCA MALE

### SPECIFICATIONS

Product type:	Audio Adapter
Type:	2-fold
Connector 1:	RCA
Gender of connector 1:	female
Poles of connector 1:	2
Connector 2:	RCA
Gender of connector 2:	female
Poles of connector 2:	2
Housing:	plastic



## 7553

ADAPTER MONO RCA MALE TO MONO RCA MALE

### SPECIFICATIONS

Product type:	Audio Adapter
Connector 1:	RCA
Gender of connector 1:	male
Poles of connector 1:	2
Connector 2:	RCA
Gender of connector 2:	male
Poles of connector 2:	2
Housing:	plastic



## 7544

ADAPTER 6.3 MM STEREO JACK FEMALE TO 3.5 MM STEREO JACK

### SPECIFICATIONS

Product type:	Audio Adapter
Connector 1:	6.3 mm Jack
Gender of connector 1:	female
Poles of connector 1:	3
Connector 2:	3.5 mm Jack
Gender of connector 2:	male
Poles of connector 2:	3
Housing:	plastic



## 7545

Y-ADAPTER 2 X 3.5 MM STEREO JACK FEMALE TO 6.3 MM STEREO

### SPECIFICATIONS

Product type:	Audio Adapter
Type:	Y-Adapter
Connector 1:	6.3 mm Jack
Gender of connector 1:	male
Poles of connector 1:	3
Connector 2:	3.5 mm Jack
Gender of connector 2:	female
Poles of connector 2:	3
Housing:	plastic



## 7541

ADAPTER 6.3 MM MONO JACK FEMALE TO MONO RCA MALE

### SPECIFICATIONS

Product type:	Audio Adapter
Connector 1:	6.3 mm Jack
Gender of connector 1:	female
Poles of connector 1:	2
Connector 2:	RCA
Gender of connector 2:	male
Poles of connector 2:	2
Housing:	metal



### NAC3FCA

POWERCON PLUG BLUE

#### SPECIFICATIONS

Product type:	powerCON jack
Poles:	3
Gender:	female
Colour marker:	blue
Contacts:	nickel plated
Connection type:	Screw terminals
Housing:	polyamide
Width:	26 mm
Height:	26 mm
Depth:	73 mm



### NAC3FCB

POWERCON PLUG GREY

#### SPECIFICATIONS

Product type:	powerCON jack
Poles:	3
Gender:	female
Colour marker:	grey
Contacts:	nickel plated
Connection type:	Screw terminals
Housing:	polyamide
Width:	26 mm
Height:	26 mm
Depth:	73 mm



### NAC3MPA-1

POWERCON SOCKET BLUE

#### SPECIFICATIONS

Product type:	powerCON jack
Poles:	3
Gender:	female
Contacts:	Bronze
Connection type:	Flat tabs
Housing:	polyamide
Width:	26 mm
Height:	31 mm
Depth:	37 mm
Additional information:	in D-type housing



### NAC3MPB-1

POWERCON SOCKET GREY

#### SPECIFICATIONS

Product type:	powerCON jack
Poles:	3
Gender:	female
Contacts:	Bronze
Connection type:	Flat tabs
Housing:	polyamide
Width:	26 mm
Height:	31 mm
Depth:	37 mm
Additional information:	in D-type housing



### NC3MX / BAG

XLR PLUG MALE

#### SPECIFICATIONS

Product type:	XLR connector
Type:	audio
Poles:	3
Gender:	male
Cable diameter:	3.5 - 8 mm
Contacts:	silver plated
Connection type:	solder contact
Housing:	die-cast zinc
Strain relief:	polyacetal
Length:	69 mm
Diameter:	19 mm



### NC3FX / BAG

XLR PLUG FEMALE

#### SPECIFICATIONS

Product type:	XLR Socket
Poles:	3
Gender:	female
Contacts:	Bronze
Connection type:	solder contacts
Housing:	die-cast zinc
Width:	19 mm
Height:	19 mm
Depth:	72 mm





### NC3MXX / BAG

XLR PLUG MALE SILVER / BLACK

#### SPECIFICATIONS

Product type:	XLR connector
Type:	audio
Poles:	3
Gender:	male
Cable diameter:	3.5 - 8 mm
Contacts:	silver plated
Connection type:	solder contact
Colour:	silver / black
Housing:	die-cast zinc
Strain relief:	polyacetal
Length:	69 mm
Diameter:	19 mm



### NC3FXX / BAG

XLR PLUG FEMALE

#### SPECIFICATIONS

Product type:	XLR Socket
Poles:	3
Gender:	female
Contacts:	Bronze / silver plated
Connection type:	solder contacts
Housing:	die-cast zinc
Width:	19.2 mm
Height:	19.2 mm
Depth:	73.5 mm



### NC3MDL1BAG

XLR CHASSIS CONNECTOR MALE  
BLACK

#### SPECIFICATIONS

Product type:	XLR Socket
Poles:	3
Gender:	male
Contacts:	silver plated
Connection type:	solder contacts
Housing:	die-cast zinc
Width:	26 mm
Height:	31 mm
Depth:	21 mm
Additional information:	in D-type housing



### NC3FDL1 / BAG

XLR CHASSIS CONNECTOR FEMALE /  
BLACK

#### SPECIFICATIONS

Product type:	XLR Socket
Poles:	3
Gender:	female
Contacts:	silver plated
Connection type:	solder contacts
Housing:	die-cast zinc
Width:	26 mm
Height:	31 mm
Depth:	24 mm
Additional information:	in D-type housing



### NL2FX

SPEAKON PLUG 2-POLE

#### SPECIFICATIONS

Product type:	loudspeaker connectors
Type:	speaKON
Poles:	2
Gender:	female
Cable diameter:	6 mm
Contacts:	gold plated
Connection type:	screws/solder contacts
Colour:	blue
Housing:	PBTP 20 % GR
Strain relief:	polyacetal
Length:	68.8 mm
Diameter:	23.7 mm



### NL4FC

SPEAKON PLUG 4-POLE

#### SPECIFICATIONS

Product type:	loudspeaker connectors
Type:	speaKON
Poles:	4
Gender:	female
Cable diameter:	6 - 11 mm
Contacts:	nickel plated
Connection type:	screws/solder contacts
Colour:	blue
Housing:	polyamide
Strain relief:	polyacetal
Length:	73 mm
Diameter:	26 mm



### NL4FX

SPEAKON PLUG 4-POLE

#### SPECIFICATIONS

Product type:	loudspeaker connectors
Type:	speakON
Poles:	4
Gender:	female
Cable diameter:	7 - 14.5 mm
Colour marker:	blue
Contacts:	nickel plated
Connection type:	screws/solder contacts
Colour:	darl grey
Housing:	die-cast zinc
Strain relief:	polyacetal
Length:	76.5 mm
Diameter:	26 mm



### NL8FC

SPEAKON PLUG 8-POLE

#### SPECIFICATIONS

Product type:	loudspeaker connectors
Type:	speakON
Poles:	8
Gender:	female
Cable diameter:	8 - 20 mm
Contacts:	nickel plated
Connection type:	screws/solder contacts
Colour:	blue
Housing:	polyamide
Strain relief:	polyacetal
Length:	85 mm
Diameter:	36.2 mm



### NL4MMX

ADAPTER SPEAKON 2/4-POLE TO SPEAKON 2/4-POLE

#### SPECIFICATIONS

Product type:	Speaker Adapter
Connector 1:	speakON
Gender of connector 1:	male
Poles of connector 1:	4
Connector 2:	speakON
Gender of connector 2:	male
Poles of connector 2:	4
Housing:	polyamide
Depth:	72 mm



### NL4MP

SPEAKON CHASSIS CONNECTOR

#### SPECIFICATIONS

Product type:	speakON socket
Poles:	4
Gender:	male
Contacts:	Bronze
Connection type:	Flat tabs
Housing:	polyamide
Width:	26 mm
Height:	31 mm
Depth:	35 mm
Additional information:	in D-type housing



### NL4MPR

SPEAKON CHASSIS CONNECTOR ROUND

#### SPECIFICATIONS

Product type:	speakON socket
Poles:	4
Gender:	male
Contacts:	Bronze
Connection type:	Flat tabs
Housing:	polyamide
Width:	51 mm
Height:	51 mm
Depth:	35 mm



### NE8FDPB

RJ45 FEEDTHROUGH RECEPTACLE

#### SPECIFICATIONS

Product type:	RJ45 Feedthrough Receptacle
Poles:	8
Gender:	female
Contacts:	Bronze
Connection type:	RJ45 plug
Housing:	die-cast zinc
Width:	26 mm
Height:	31 mm
Depth:	39 mm
Additional information:	in D-type housing, mounting screws included



### NA3FF

ADAPTER XLR FEMALE TO XLR FEMALE

#### SPECIFICATIONS

Product type:	DMX Adapter
Connector 1:	XLR
Gender of connector 1:	female
Poles of connector 1:	3
Connector 2:	XLR
Gender of connector 2:	female
Poles of connector 2:	3
Housing:	die-cast zinc



### NA3MM

ADAPTER XLR MALE TO XLR MALE

#### SPECIFICATIONS

Product type:	DMX Adapter
Connector 1:	XLR
Gender of connector 1:	male
Poles of connector 1:	3
Connector 2:	XLR
Gender of connector 2:	male
Poles of connector 2:	3
Housing:	die-cast zinc

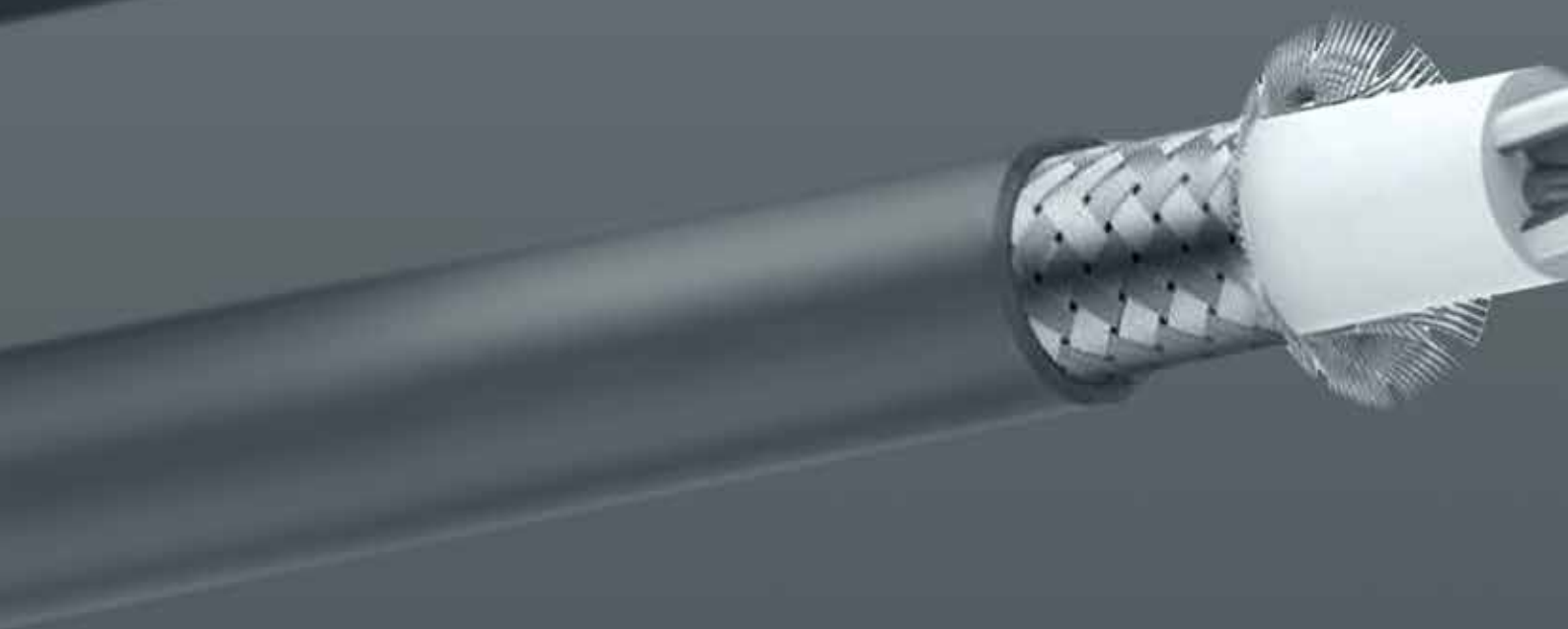
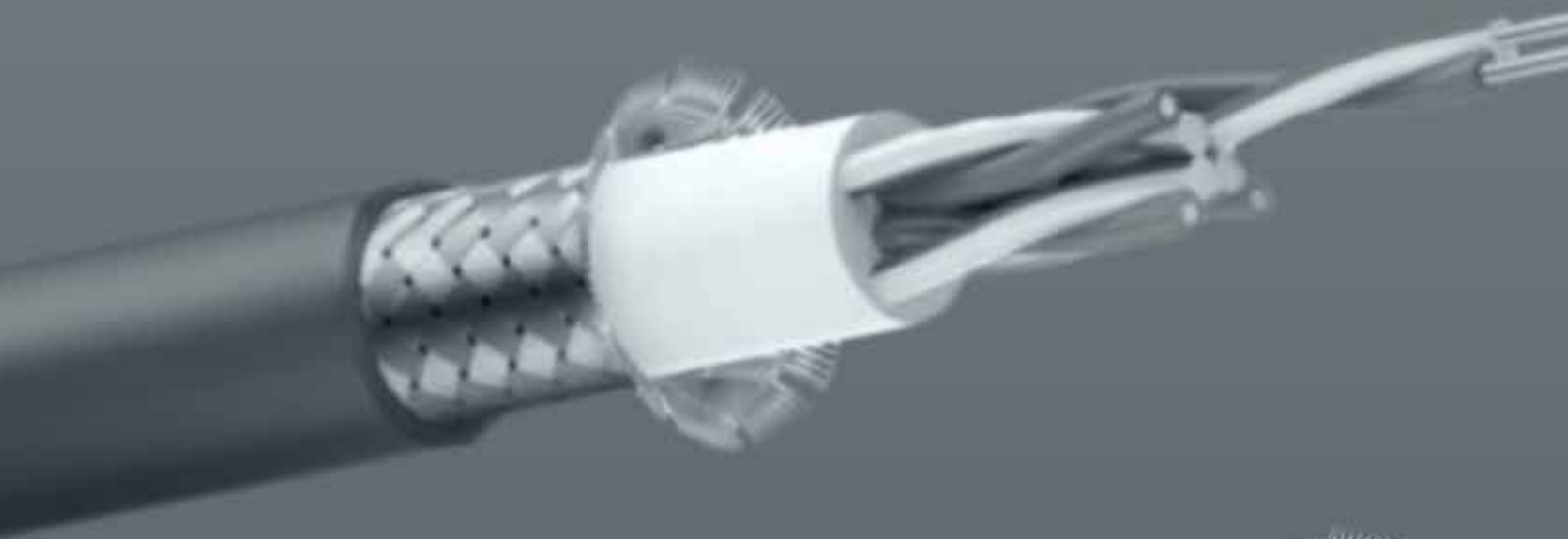

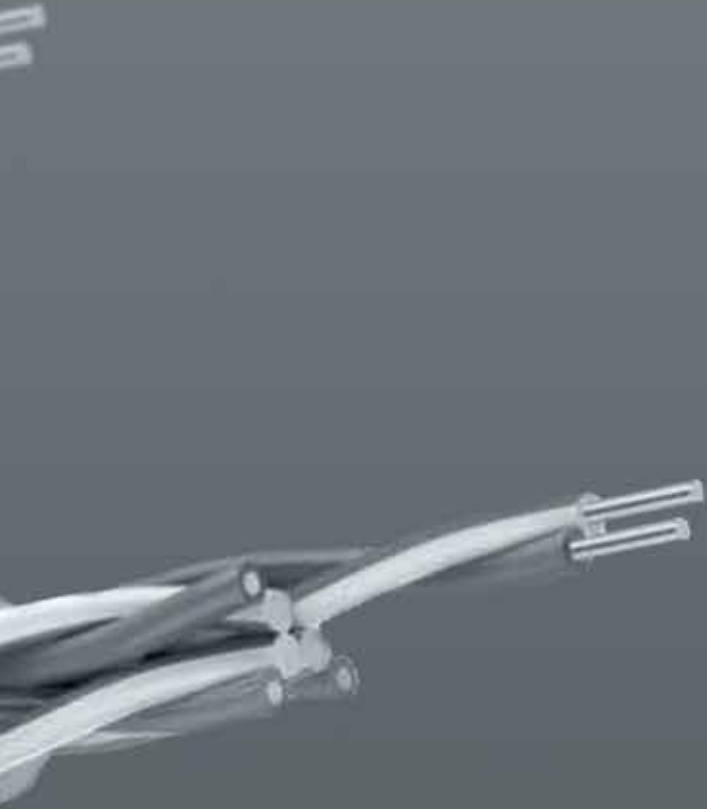

## **BULK CABLES**

We stock a wide variety of bulk cable for all professional applications including microphone, instrument and speaker cable, CAT5, DMX, video and multicore cable or combination signal and power cable.

# BULK CABLES

## 7114

MICROPHONE CABLE

### SPECIFICATIONS

Product type:	Microphone cable
Colour:	black
Overall diameter:	6.0 mm +/- 0.2 mm
Jacket material:	PVC
AWG:	22AWG
cross section:	0.31 mm <sup>2</sup>
Insulation:	PE 1.50mm
Composition of conductor:	28 x 0.12 mm, bare cooper, OFC
Number of inner conductors:	2
Shielding:	tin plated cooper spiral shielding with 96 x 0,12 mm
Conductor resistance:	55 Ω/km
Capacitance Cond./Cond.:	<72 pF/m

## 7116

MICROPHONE CABLE

### SPECIFICATIONS

Product type:	Microphone cable
Colour:	black
Overall diameter:	6.5 mm +/- 0.2 mm
Jacket material:	PVC
AWG:	24
cross section:	0.22 mm <sup>2</sup>
Insulation:	PE 1.4 mm
Composition of conductor:	28 x 0,1mm, bare cooper, OFC
Number of inner conductors:	2
Shielding:	cooper spiral shielding with 80 x 0,10 mm
Conductor resistance:	87 Ω/km
Capacitance Cond./Cond.:	68 pF/m

## 7118

MICROPHONE CABLE

### SPECIFICATIONS

Product type:	Microphone cable
Colour:	black
Overall diameter:	6.8 mm +/- 0.2 mm
Jacket material:	PVC
AWG:	24
cross section:	0.22 mm <sup>2</sup>
Insulation:	PE 1.4 mm
Composition of conductor:	28 x 0.10 mm, bare cooper, OFC
Number of inner conductors:	2
Shielding:	cooper spiral shielding with 80x0.10 mm + semiconductor
Conductor resistance:	53 Ω/km
Capacitance Cond./Cond.:	68/ pF/m



Capacitance Cond./Shield.:	130 pF/m
Insulation Resistance:	> 1 GΩ
Working Temperature:	-20° to +70°
Surge Impedance:	100ohm

### FEATURES

- Fine stranded wire for high-quality signal transmission
- High flexibility makes it easy to reel e.g excelent for cable drums
- Extremely good price-performance ratio



Capacitance Cond./Shield.:	130 pF/m
Insulation Resistance:	> 1 GΩ
Working Temperature:	-20° to +70°
Surge Impedance:	100 ohm

### FEATURES

- Fine stranded wire for high-quality signal transmission
- Very robust and thick soft PVC jacket
- Good shielding by dense helical copper spirial shielding
- High flexibility makes it easy to reel e.g excelent for cable drums
- Extremely good price-performance ratio



Capacitance Cond./Shield.:	130 pF/m
Insulation Resistance:	> 1 GΩ x km
Working Temperature:	-20° to +70°
Surge Impedance:	100 ohm

### FEATURES

- Fine stranded wire for high-quality signal transmission
- Extremely robust and very thick soft PVC jacket
- 100% shielding due dense copper spiral shielding and semiconductor
- High flexibility makes it easy to reel e.g. excellent for cable drums

# BULK CABLES

## 7119

MICROPHONE CABLE

### SPECIFICATIONS

Product type:	Microphone cable
Colour:	black
Overall diameter:	6.5 mm +/- 0.2 mm
Jacket material:	PVC
AWG:	22
cross section:	0.3 mm <sup>2</sup>
Insulation:	PE 1.5 mm
Composition of conductor:	38 x 0.10 mm, bare cooper, OFC
Number of inner conductors:	2
Shielding:	tin plated copper braided shielding with 128 x 0.10 mm
Conductor resistance:	53 Ω/km
Capacitance Cond./Cond.:	60 pF/m



Capacitance Cond./Shield.:	120 pF/m
Insulation Resistance:	> 1 GΩ x km
Working Temperature:	-20° to +70°
Surge Impedance:	100 ohm

### FEATURES

- High Quality signal transmission thanks to OFC stranding
- Very low capacity due to PE insulation
- Very good protection due to the copper braided shielding
- High flexibility makes it easy to reel e.g. excellent for cable drums

## 7120

MICROPHONE CABLE

### SPECIFICATIONS

Product type:	Microphone Cable
Colour:	black
Overall diameter:	6,8mm +/- 0.2 mm
Jacket material:	PVC
AWG:	20AWG
cross section:	0,50 mm <sup>2</sup>
Insulation:	PE 1.65 mm
Composition of conductor:	28 x 0.15 mm, bare cooper, OFC
Number of inner conductors:	2
Shielding:	tin plated cooper spiral shielding 80x0.10mm with additional AL fleece
Conductor resistance:	37 Ω/km
Capacitance Cond./Cond.:	80 pF



Capacitance Cond./Shield.:	145 pF/m
Insulation Resistance:	> 1 GΩ
Working Temperature:	-20° to +70°
Surge Impedance:	110 Ω

### FEATURES

- Optimum transmission quality even for long length due to large diameter
- 100% cooper spiral shielding and additional AL fleece
- High durability due to a thick PVC jacket

## KMK222#

MICROPHONE CABLE 2 X 0.34 MM<sup>2</sup>

### SPECIFICATIONS

Product type:	Microphone cable
Overall diameter:	6.2 mm
Center conductor cross section:	0.32 mm <sup>2</sup>
Center conductor material:	copper
Center conductor construction:	19 x 0.15 mm
Number of internal conductors:	2
Shield material:	Copper, OFC
Shield:	Spiral shielding
Line resistance:	<53 Ohm(s)
Capacitance:	< 58 pF/m
Jacket material:	PVC



Article No.	Color
KMK222S	Black
KMK222B	Blue
KMK222R	Red



# BULK CABLES

## KMK222ST#

MICROPHONE CABLE 2 X 0.22 MM<sup>2</sup>

### SPECIFICATIONS

Product type:	Mic
Colour:	black
Overall diameter:	6.4 mm
Center conductor cross section:	0.22 mm <sup>2</sup>
Center conductor material:	copper
Center conductor construction:	28 x 0.1 mm
Number of internal conductors:	2
Shield material:	Copper, OFC
Shield:	Spiral shielding
Line resistance:	<87 Ohm(s)
Capacitance:	<68 pF/m
Jacket material:	PVC



Article No.	Color
KMK222STS	Black
KMK222STB	Blue
KMK222STG	Grey
KMK222STGR	Green
KMK222STV	Violet
KMK222STY	Yellow
KMK222STR	Red

## KMKP222#

MICROPHONE CABLE 2 X 0.22 MM<sup>2</sup>

### SPECIFICATIONS

Product type:	Microphone cable
Colour:	black
Overall diameter:	6.5 mm
Center conductor cross section:	0.22 mm <sup>2</sup>
Center conductor material:	copper
Center conductor construction:	32 x 0.1 mm
Number of internal conductors:	2
Shield material:	Copper / aluminium foil
Shield:	Braided / wound shielding
Line resistance:	<80 Ohm(s)
Capacitance:	60 pF/m
Jacket material:	PVC



Article No.	Color
KMKP222S	Black
KMKP222B	Blue
KMKP222R	Red

## KMK250S

MICROPHONE CABLE 2 X 0.50 MM<sup>2</sup>

### SPECIFICATIONS

Product type:	Microphone cable
Colour:	black
Overall diameter:	6.7 mm
Center conductor cross section:	0.5 mm <sup>2</sup>
Center conductor material:	copper
Center conductor construction:	28 x 0.15 mm
Number of internal conductors:	2
Shield material:	Copper tin-plated / aluminium fleece
Shield:	Braided / wound shielding
Line resistance:	37 Ohm(s)
Capacitance:	80 pF/m
Jacket material:	PVC



# BULK CABLES

## 7115

INSTRUMENT CABLE BLUE

### SPECIFICATIONS

Product type:	Instrument cables
Colour:	black
Overall diameter:	6.0 mm +/- 0.2 mm
Jacket material:	PVC
AWG:	23AWG
cross section:	0.22 mm <sup>2</sup>
Insulation:	PE 1.4mm
Composition of conductor:	20 x 0,12mm, bare cooper, OFC
Number of inner conductors:	1
Shielding:	cooper spiral shielding with 64 x 0,12 mm + semiconductor

## 7117

HIGH-END INSTRUMENT CABLE

### SPECIFICATIONS

Product type:	Instrument cable
Colour:	black
Overall diameter:	7.0 mm +/- 0.2 mm
Jacket material:	PVC
AWG:	19
cross section:	0.75 mm <sup>2</sup>
Insulation:	PE 3.1 mm
Composition of conductor:	42 x 0.15 mm, tin plated copper, OFC
Number of inner conductors:	1
Shielding:	tin plated copper braided shielding with 128 x 0.10 mm + semiconductor
Conductor resistance:	25 Ω/km
Capacitance Cond./Shield.:	88 pF/m
Insulation Resistance:	> 50 MΩ
Working Temperature:	-20° to +70°

## KIK150

INSTRUMENT CABLE 1 X 0.50 MM<sup>2</sup>

### SPECIFICATIONS

Product type:	instrument cables
Colour:	black
Overall diameter:	7 mm
Center conductor cross section:	0.5 mm <sup>2</sup>
Center conductor material:	copper
Center conductor construction:	28 x 0.15 mmm
Number of internal conductors:	1
Shield material:	Copper, tin-plated
Shield:	Braided shielding
Line resistance:	<90 Ohm(s)
Capacitance:	<85 pF/m
Jacket material:	PVC



Conductor resistance:	90 Ω/km
Capacitance Cond./Shield.:	8 pF/m
Insulation Resistance:	> 1 GΩ x km
Working Temperature:	-20° to +70°

### FEATURES

- Fine stranded wire for high-quality signal transmission
- 100% protected due to double shielding
- High flexibility makes it easy to wind
- Extremely good price-performance ratio



### FEATURES

- Professional high-end instrument cable
- For all electrical instruments such as guitars, basses, keyboards, effects pedals
- Neutral transmission over the whole frequency range
- For the most demanding live, Studio and hi-fi applications
- Double shielded against impact noise and EMI
- Rugged, durable structure due to a special high quality PVC jacket
- very flexible and easy to wind due to fine individual stranding



# BULK CABLES

## K3DMXAES

AES/EBU AND DMX CABLE 110-OHM DIGITAL BLACK

### SPECIFICATIONS

Type:	DMX AES/EBU Cable
Color:	black
Overall diameter:	5.8 mm +/- 0.2 mm
Conductor area:	0.22 mm <sup>2</sup>
Conductor material:	bare copper, OFC
Composition of conductor:	28 x 0.1 mm
Number of Conductors:	2
Screen material:	copper
Screen:	Braided wound
Conductor resistance:	53 Ohm / km
Capacity:	68 pF/m
Jacket material:	PVC



## 7121

AES/EBU AND DMX CABLE 110-OHM BLACK

### SPECIFICATIONS

Product type:	AES / EBU & DMX Cable
Colour:	black
Overall diameter:	6.5 mm +/- 0.2 mm
Jacket material:	PVC
AWG:	22
cross section:	0.34 mm <sup>2</sup>
Insulation:	PE 1,7 mm
Composition of conductor:	7x 0.25 mm, bare cooper, OFC
Number of inner conductors:	2
Shielding:	cooper spiral shielding with 80 x 0,10 mm + AL/PT-foil + PE filler
Conductor resistance:	53 Ω/km
Capacitance Cond./Cond.:	< 65 pF/m



Capacitance Cond./Shield.:	115pF/m
Insulation Resistance:	> 10 GΩ x km
Working Temperature:	-20° to +70°
Surge Impedance:	110 ohm

### FEATURES

- AES/EBU and DMX compliant cable
- highly flexible
- very good shielding
- High Quality signal transmission due to large conductor cross section and OFC strands

## 7122

110 OHM AES/EBU AND DMX 2-PAIR DIGITAL CABLE

### SPECIFICATIONS

Product type:	AES / EBU & DMX Cable
Colour:	black
Overall diameter:	6.5 mm +/- 0.2 mm
Jacket material:	PVC
AWG:	26
cross section:	0.12 mm <sup>2</sup>
Insulation:	PE 1.5 mm
Composition of conductor:	10 x 0.12 mm, Copper, tin-plated, OFC
Number of inner conductors:	4
Shielding:	tin plated copper braided shielding with 96x 0.12mm + AL/PT-Foil + PE filler
Conductor resistance:	140Ω/KM
Capacitance Cond./Cond.:	40pF/M



Capacitance Cond./Shield.:	80pF/M
Insulation Resistance:	1GΩ/KM
Working Temperature:	-20° to +70°
Surge Impedance:	110 ohm

### FEATURES

- 110 ohm 2-pair digital cable
- For DMX full duplex, AES-EBU, analog and digital audio, MIDI and data
- Durable and flexible construction
- Dual shielding for 100% EMI protection

# BULK CABLES

## KCDMX30

DMX CABLE 2 X 0.23 MM<sup>2</sup>

### SPECIFICATIONS

Product type:	DMX Cable
Colour:	black
Overall diameter:	6 mm
Center conductor cross section:	0.23 mm <sup>2</sup>
Center conductor material:	copper
Center conductor construction:	20 x 0.12 mm
Number of internal conductors:	2
Shield material:	copper
Shield:	Braided shielding
Line surge impedance:	110 Ohm(s)
Jacket material:	PVC



## KMK234AES#

AES/EBU AND DMX CABLE 110-OHM DIGITAL BLUE

### SPECIFICATIONS

Product type:	AES / EBU & DMX Cable
Overall diameter:	6.4 mm
Center conductor cross section:	0.34 mm <sup>2</sup>
Center conductor material:	copper
Center conductor construction:	19 x 0.15 vv
Number of internal conductors:	2
Shield material:	Copper / aluminium fleece
Shield:	Braided / wound shielding
Line surge impedance:	110 Ohm(s)
Line resistance:	<53 Ohm(s)
Capacitance:	65 pF/m
Jacket material:	PVC



Article No.	Color
KMK234AES	Black
KMK234AEB	Blue

## KCCXV107

COAX VIDEO CABLE 0.54 MM<sup>2</sup> GREEN

### SPECIFICATIONS

Product type:	Coaxial Video Cable
Colour:	green
Overall diameter:	7 mm
Center conductor cross section:	0.54 mm <sup>2</sup>
Center conductor material:	copper
Center conductor construction:	48 x 0.12 mm
Number of internal conductors:	1
Shield material:	copper
Shield:	Braided shielding
Line surge impedance:	75 Ohm(s)
Line resistance:	4 Ohm(s)
Capacitance:	58 pF/m
Jacket material:	PVC



# BULK CABLES

## 7123

LOW SMOKE ZERO HALOGEN CAT5E CABLE

### SPECIFICATIONS

Product type:	CAT5e data cable
Colour:	blue
Overall diameter:	6.4 mm +/- 0.2 mm
Jacket material:	TPU
AWG:	26
cross section:	0.15 mm <sup>2</sup>
Insulation:	HDPE
Composition of conductor:	19 x 0.10 mm, bare cooper, OFC
Number of inner conductors:	4x2
Shielding:	tin plated copper braided shielding with 128 x 0,10mm
Conductor resistance:	< 85 Ω/km
Capacitance Cond./Cond.:	60 pF/m



Capacitance Cond./Shield.:	110 pF/m
Insulation Resistance:	> 10 GΩ
Working Temperature:	-40° to +85°
Surge Impedance:	100 ohm

### FEATURES

- Highly flexible LSZH Cat5e cable
- Braid shield with 4 unshielded twisted pairs (S/UTP)
- Flame-retardant TPU jacket
- EtherSound compatible up to 70 m

## 7124

OFC TWIN CABLE

### SPECIFICATIONS

Product type:	Twin cable
Colour:	black
Overall diameter:	4 x 8 mm +/- 0.2 mm
Jacket material:	PVC
AWG:	26AWG
cross section:	0.14 mm <sup>2</sup>
Insulation:	PE 1.4 mm
Composition of conductor:	18 x 0.10 mm, bare cooper, OFC
Number of inner conductors:	2
Shielding:	copper spiral shielding with 36 x 0,10mm
Conductor resistance:	125 Ω/km
Capacitance Cond./Shield.:	250 pF/m



Insulation Resistance:	> 1 GΩ
Working Temperature:	-20° to +70°

### FEATURES

- very flexible due to fine stranding
- individually shielded conductors
- small diameter for perfekt match with RCA and jack connectors

## 7125

OFC TWIN STEREO CABLE

### SPECIFICATIONS

Product type:	Twin cable stereo
Colour:	black
Overall diameter:	4 x 8 mm +/- 0.2 mm
Jacket material:	PVC
AWG:	26AWG
cross section:	0.14 mm <sup>2</sup>
Insulation:	PE 1.3mm
Composition of conductor:	18 x 0.10 mm bare cooper, OFC
Number of inner conductors:	2x2
Shielding:	copper spiral shielding with 58 x 0.10 mm
Conductor resistance:	125 Ω/km
Capacitance Cond./Cond.:	145 pF



Capacitance Cond./Shield.:	250 pF/m
Insulation Resistance:	> 1 GΩ
Working Temperature:	-20° to +70°
Surge Impedance:	110 Ω

### FEATURES

- very flexible due to fine stranding
- individually shielded conductors
- small diameter for perfekt match with RCA and jack connectors

# BULK CABLES

## 7126

OFC TWIN STEREO CABLE

### SPECIFICATIONS

Product type:	Twin cable stereo
Colour:	black
Overall diameter:	5 x 10 mm +/- 0.2 mm
Jacket material:	PVC
AWG:	24 AWG
cross section:	0.22 mm <sup>2</sup>
Insulation:	PE 1.4mm
Composition of conductor:	28 x 0.10 mm bare cooper, OFC
Number of inner conductors:	2x2
Shielding:	AL fleece
Conductor resistance:	85 Ω/km
Capacitance Cond./Cond.:	75 pF
Capacitance Cond./Shield.:	120 pF/m



Insulation Resistance:	> 10 GΩ
Working Temperature:	-20° to +70°
Surge Impedance:	100 Ω

### FEATURES

- High Quality transmission due to large conductor cross section
- Excelent shielding provided by AL fleece and drain wire
- small diameter for perfekt match with XLR, RCA and jack connectors

## KCSIG48

TWIN CABLE 2 X 0.16 MM<sup>2</sup>

### SPECIFICATIONS

Product type:	Stereo Signal Cable
Colour:	black
Overall diameter:	2 x 4,0 mm
Center conductor cross section:	0.16 mm <sup>2</sup>
Center conductor material:	copper
Center conductor construction:	14 x 0.12 mm
Number of internal conductors:	2
Shield material:	Copper tin-plated
Shield:	Spiral shielding
Line resistance:	16 Ohm(s)
Capacitance:	98 pF/m
Jacket material:	PVC



## KCSIG58

TWIN CABLE STEREO 4 X 0.16 MM<sup>2</sup>

### SPECIFICATIONS

Product type:	Stereo Signal Cable
Colour:	black
Overall diameter:	2 x 4.0 mm
Center conductor cross section:	0.16 mm <sup>2</sup>
Center conductor material:	copper
Center conductor construction:	14 x 0.12 mm
Number of internal conductors:	4
Shield material:	Copper tin-plated
Shield:	Spiral shielding
Line resistance:	16 Ohm(s)
Capacitance:	98 pF/m
Jacket material:	PVC
Additional information:	twisted in pairs



# BULK CABLES

## KIK125T

TWIN CABLE 2 X 0.25 MM<sup>2</sup>

### SPECIFICATIONS

Product type:	Twin Instrument Cable
Colour:	black
Overall diameter:	2 x 3.8 mm
Center conductor cross section:	0.25 mm <sup>2</sup>
Center conductor material:	copper
Center conductor construction:	32 x 0.1 mm
Number of internal conductors:	2
Shield material:	Copper, OFC
Shield:	Spiral shielding
Line resistance:	<115 Ohm(s)
Capacitance:	<60 pF/m
Jacket material:	PVC



## KCPC3G15

POWER CABLE 3 X 1.5 MM<sup>2</sup>

### SPECIFICATIONS

Product type:	Power cord
Colour:	black
Overall diameter:	8 mm
Center conductor cross section:	1.5 mm <sup>2</sup>
Center conductor material:	copper
Center conductor construction:	48 x 0.2 mm
Number of internal conductors:	3
Line resistance:	1.2 Ohm(s)
Jacket material:	PVC



## KCPAC50

AUDIO AND POWER CABLE 2 X 0.125 MM<sup>2</sup> + 3 X 1 MM<sup>2</sup>

### SPECIFICATIONS

Product type:	Audio / Power Cable
Colour:	black
Overall diameter:	14 mm
Jacket material:	PVC
HEADLINE 1:	Inner conductor 1
Inner conductor type:	Audio cable
Conductor cross-section:	0.125 mm <sup>2</sup>
Conductor material:	Copper tin-plated
Conductor construction:	7 x 0.15 mm
Number of conductors:	2
Shielding material:	Copper tin-plated
Shield:	spiral
Line resistance:	13.75 Ohm(s)
Capacitance:	54 pF/m



HEADLINE 2:	Inner conductor 2
Inner conductor 2 type:	Mains supply line
Inner conductor 2 cross-section:	1 mm <sup>2</sup>
Inner conductor 2 material:	bare copper
Inner conductor 2 construction:	58 x 0.15 mm
Number of inner conductors 2:	3
Line resistance inner conductor 2:	1.35 Ohm(s)
Other features:	max. 450 V / 10 A



# BULK CABLES

## KLP1

AES/EBU POWER COMBINATION CABLE 2 X 0.14 MM<sup>2</sup> + 3 X 1.5 MM<sup>2</sup>

### SPECIFICATIONS

Product type:	AES/EBU / Power Cable
Colour:	black
Overall diameter:	12 mm
Jacket material:	PVC
HEADLINE 1:	Inner conductor 1
Inner conductor type:	Mains supply line
Conductor cross-section:	1.5 mm <sup>2</sup>
Conductor material:	bare copper
Conductor construction:	48 x 0.2 mm
Number of conductors:	3
HEADLINE 2:	Inner conductor 2
Inner conductor 2 type:	audio/DMX
Inner conductor 2 cross-section:	0.14 mm <sup>2</sup>
Inner conductor 2 material:	bare copper

## KLP2

AES/EBU POWER COMBINATION CABLE 4 X 0.14 MM<sup>2</sup> + 3 X 1.5 MM<sup>2</sup>

### SPECIFICATIONS

Product type:	AES/EBU / Power Cable
Colour:	black
Overall diameter:	12.3 mm
Jacket material:	PVC
HEADLINE 1:	Inner conductor 1
Inner conductor type:	Mains supply line
Conductor cross-section:	1.5 mm <sup>2</sup>
Conductor material:	bare copper
Conductor construction:	48 x 0.2 mm
Number of conductors:	3
HEADLINE 2:	Inner conductor 2
Inner conductor 2 type:	audio/DMX

## KLP4

AES/EBU POWER COMBINATION CABLE 8 X 0.14 MM<sup>2</sup> + 3 X 1.5 MM<sup>2</sup>

### SPECIFICATIONS

Product type:	AES/EBU / Power Cable
Colour:	black
Overall diameter:	13.2 mm
Jacket material:	PVC
HEADLINE 1:	Inner conductor 1
Inner conductor type:	Mains supply line
Conductor cross-section:	1.5 mm <sup>2</sup>
Conductor material:	bare copper
Conductor construction:	48 x 0.2 mm
Number of conductors:	3
HEADLINE 2:	Inner conductor 2
Inner conductor 2 type:	audio/DMX



Inner conductor 2 construction:	36 x 0.07 mm
Number of inner conductors 2:	2
Inner conductor 2 shielding material:	Copper tin-plated
Inner conductor 2 shielding:	spiral
Characteristic impedance inner conductor 2:	110 Ohm(s)
Line resistance inner conductor 2:	< 80 Ohm(s)
Inner conductor 2 capacitance:	52 pF/m
Other features:	DMX line shielded and insulated in pairs



Inner conductor 2 cross-section:	0.14 mm <sup>2</sup>
Inner conductor 2 material:	bare copper
Inner conductor 2 construction:	36 x 0.07 mm
Number of inner conductors 2:	4
Inner conductor 2 shielding material:	Copper tin-plated
Inner conductor 2 shielding:	spiral
Characteristic impedance inner conductor 2:	110 Ohm(s)
Line resistance inner conductor 2:	< 80 Ohm(s)
Inner conductor 2 capacitance:	52 pF/m
Other features:	DMX line shielded and insulated in pairs



Inner conductor 2 cross-section:	0.14 mm <sup>2</sup>
Inner conductor 2 material:	bare copper
Inner conductor 2 construction:	36 x 0.07 mm
Number of inner conductors 2:	8
Inner conductor 2 shielding material:	Copper tin-plated
Inner conductor 2 shielding:	spiral
Characteristic impedance inner conductor 2:	110 Ohm(s)
Line resistance inner conductor 2:	< 80 Ohm(s)
Inner conductor 2 capacitance:	52 pF/m

# BULK CABLES

## KLS215

SPEAKER CABLE 2 X 1.5 MM<sup>2</sup>

### SPECIFICATIONS

Product type:	Speaker cable
Colour:	dark grey
Overall diameter:	6.8 mm +/- 0.2 mm
Jacket material:	PVC
AWG:	16
cross section:	1.5 mm <sup>2</sup>
Composition of conductor:	30 x 0.25 mm, Copper bare, OFC
Number of inner conductors:	2
conductor PVC insulation diameter	2.6 mm
Conductor resistance:	13Ω / km
Working Temperature:	-20° to +70°



### FEATURES

- Speaker cable 2 x 1.5 mm<sup>2</sup>
- Especially designed for connecting loudspeakers
- Low-oxygen copper strands ensure better transmission quality
- Long lifespan
- Very flexible and well-suited for use with cable drums

## KLS215TC

SPEAKER CABLE 2 X 1.5 MM<sup>2</sup> TRANSPARENT

### SPECIFICATIONS

Product type:	Speaker Cables
Colour:	transparent
Overall diameter:	6.5 x 2.8 mm
Center conductor cross section:	1.5 mm <sup>2</sup>
Center conductor material:	copper
Center conductor construction:	84 x 0.15 mm
Number of internal conductors:	2
Capacitance:	67 pF/m
Jacket material:	PVC



## KCLS215W

SPEAKER CABLE 2 X 1.5 MM<sup>2</sup> WHITE

### SPECIFICATIONS

Product type:	Speaker Cables
Colour:	white
Overall diameter:	8 mm
Center conductor cross section:	1.5 mm <sup>2</sup>
Center conductor material:	copper
Center conductor construction:	20 x 7 x 0.12 mm
Number of internal conductors:	2
Line resistance:	1.2 Ohm(s)
Capacitance:	95 pF/m
Jacket material:	PVC



### FEATURES

- Especially designed for connecting loudspeakers
- Low-oxygen copper strands ensure better transmission quality
- Long lifespan
- Very flexible and well-suited for use with cable drums

# BULK CABLES

## KLS225

SPEAKER CABLE 2 X 2.5 MM<sup>2</sup>

### SPECIFICATIONS

Product type:	Speaker cable
Colour:	dark grey
Overall diameter:	7.8 mm +/- 0.2 mm
Jacket material:	PVC
AWG:	14
cross section:	2.5 mm <sup>2</sup>
Composition of conductor:	50 x 0.25 mm, Copper bare, OFC
Number of inner conductors:	2
conductor PVC insulation diameter	3.0 mm
Conductor resistance:	7.8 Ω / km
Working Temperature:	-20° to +70°



### FEATURES

- Speaker cable 2 x 2.5 mm<sup>2</sup>
- Especially designed for connecting loudspeakers
- Low-oxygen copper strands ensure better transmission quality
- Long lifespan
- Very flexible and well-suited for use with cable drums

## K4LS240

SPEAKER CABLE 2 X 4.0 MM<sup>2</sup> BLACK

### SPECIFICATIONS

Product type:	Speaker cable
Colour:	black
Overall diameter:	11.0 mm +/- 0.2 mm
Jacket material:	PVC
AWG:	12
cross section:	4 mm <sup>2</sup>
Composition of conductor:	80 x 0.25 mm, bare cooper, OFC
Number of inner conductors:	2
conductor PVC insulation diameter	4.0 mm
Conductor resistance:	4.5 Ω / km
Working Temperature:	-20° to +70°



### FEATURES

- Speaker cable 2 x 4.0 mm<sup>2</sup>
- Especially designed for connecting loudspeakers
- Low-oxygen copper strands ensure better transmission quality
- Long lifespan
- Very flexible and well-suited for use with cable drums

## K4LS425

SPEAKER CABLE 4 X 2.5 MM<sup>2</sup> BLACK

### SPECIFICATIONS

Product type:	Speaker cable
Colour:	black
Overall diameter:	11.0 mm +/- 0.2 mm
Jacket material:	PVC
AWG:	13
cross section:	2.5 mm <sup>2</sup>
Composition of conductor:	80 x 0.20 mm, bare cooper, OFC
Number of inner conductors:	4
conductor PVC insulation diameter	3.1 mm
Conductor resistance:	7 Ω / km
Working Temperature:	-20° to +70°



### FEATURES

- Speaker cable 4 x 2.5 mm<sup>2</sup>
- Especially designed for connecting loudspeakers
- Low-oxygen copper strands ensure better transmission quality
- Long lifespan
- Very flexible and well-suited for use with cable drums

# BULK CABLES

## K4LS440

SPEAKER CABLE 4 X 4.0 MM<sup>2</sup> BLACK

### SPECIFICATIONS

Product type:	Speaker cable
Colour:	black
Overall diameter:	13.2 mm +/- 0.2 mm
Jacket material:	PVC
AWG:	11
cross section:	4.0 mm <sup>2</sup>
Composition of conductor:	80 x 0.25 mm, bare cooper, OFC
Number of inner conductors:	4
conductor PVC insulation diameter	4.0 mm
Conductor resistance:	4.5 Ω / km
Working Temperature:	-20° to +70°



### FEATURES

- Speaker cable 4 x 4.0 mm<sup>2</sup>
- Especially designed for connecting loudspeakers
- Low-oxygen copper strands ensure better transmission quality
- Long lifespan
- Very flexible and well-suited for use with cable drums

## K4LS825

SPEAKER CABLE 8 X 2.5 MM<sup>2</sup> BLACK

### SPECIFICATIONS

Product type:	Speaker cable
Colour:	black
Overall diameter:	14.0 mm +/- 0.2 mm
Jacket material:	PVC
AWG:	13
cross section:	2.5 mm <sup>2</sup>
Composition of conductor:	80 x 0.20 mm, bare cooper, OFC
Number of inner conductors:	8
conductor PVC insulation diameter	3.1 mm
Conductor resistance:	7 Ω / km
Working Temperature:	-20° to +70°



### FEATURES

- Speaker cable 8 x 2.5 mm<sup>2</sup>
- Especially designed for connecting loudspeakers
- Low-oxygen copper strands ensure better transmission quality
- Long lifespan
- Very flexible and well-suited for use with cable drums

## KLS2#

SPEAKER CABLE

### SPECIFICATIONS

	KLS207FLB, KLS207FLW	KLS215FLB	KLS225FLB	KLS240FLB
Product type:	Speaker cable	Speaker cable	Speaker cable	Speaker cable
Colour:	black or white	black	black	black
Overall diameter:	3 x 6 mm +/- 0.2 mm	3,5 x 7 mm +/- 0.2 mm	4 x 8 mm +/- 0.2 mm	5 x 10 mm +/- 0.2 mm
Jacket material:	PVC	PVC	PVC	PVC
AWG:	19	16	14	12
cross section:	0,75 mm <sup>2</sup>	1,5 mm <sup>2</sup>	2,5 mm <sup>2</sup>	4 mm <sup>2</sup>
Composition of conductor:	24 x 0.20 mm, bare cooper, OFC	48 x 0.20 mm, bare cooper, OFC	80 x 0.20 mm, bare cooper, OFC	80 x 0.25 mm, bare cooper, OFC
Number of inner conductors:	2	2	2	2
Working Temperature:	-20° to +70°	-20° to +70°	-20° to +70°	-20° to +70°

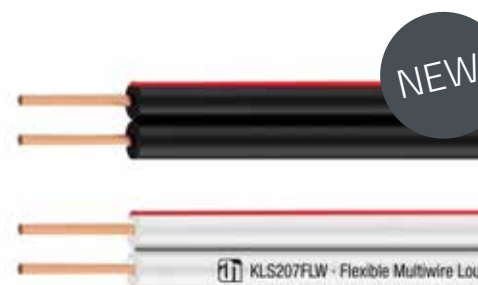

### FEATURES

- Flat Speaker cable
- Perfect for fixed installations

# BULK CABLES



## KQMC##

MULTICORE CABLE

Model name:	KQMC02	KQMC04	KQMC08	KQMC10	KQMC12	KQMC16
Product type:	Multicore cable	Multicore cable	Multicore cable	Multicore cable	Multicore cable	Multicore cable
Colour:	black	black	black	black	black	black
Overall diameter:	8.5 mm	10.2 mm	13.8 mm	14.6 mm	16 mm	17.5 mm
Center conductor cross section:	0.14 mm <sup>2</sup>	0.14 mm <sup>2</sup>	0.14 mm <sup>2</sup>	0.14 mm <sup>2</sup>	0.14 mm <sup>2</sup>	0.14 mm <sup>2</sup>
Center conductor material:	copper	copper	copper	copper	copper	copper
Center conductor construction:	36 x 0.07 mm	36 x 0.07 mm	36 x 0.07 mm	36 x 0.07 mm	36 x 0.07 mm	36 x 0.07 mm
Number of internal conductors:	4	8	16	20	24	32
Shield material:	copper	copper	copper	copper	copper	copper
Shield:	Spiral shielding	Spiral shielding	Spiral shielding	Spiral shielding	Spiral shielding	Spiral shielding
Line resistance:	<90 Ohm(s)	<90 Ohm(s)	<90 Ohm(s)	<90 Ohm(s)	<90 Ohm(s)	<90 Ohm(s)
Capacitance:	45 pF/m	45 pF/m	45 pF/m	45 pF/m	45 pF/m	45 pF/m
Jacket material:	PVC	PVC	PVC	PVC	PVC	PVC
Additional information:	Inner conductors shielded in pairs, AES/EBU-compliant	Inner conductors shielded in pairs, AES/EBU-compliant	Inner conductors shielded in pairs, AES/EBU-compliant	Inner conductors shielded in pairs, AES/EBU-compliant	Inner conductors shielded in pairs, AES/EBU-compliant	Inner conductors shielded in pairs, AES/EBU-compliant

Model name:	KQMC20	KQMC24	KQMC32	KQMC40	KQMC48
Product type:	Multicore cable	Multicore cable	Multicore cable	Multicore cable	Multicore cable
Colour:	black	black	black	black	black
Overall diameter:	19.5 mm	21.5 mm	24 mm	27.5 mm	29 mm
Center conductor cross section:	0.14 mm <sup>2</sup>	0.14 mm <sup>2</sup>	0.14 mm <sup>2</sup>	0.14 mm <sup>2</sup>	0.14 mm <sup>2</sup>
Center conductor material:	copper	copper	copper	copper	copper
Center conductor construction:	36 x 0.07 mm	36 x 0.07 mm	36 x 0.07 mm	36 x 0.07 mm	36 x 0.07 mm
Number of internal conductors:	40	48	64	80	96
Shield material:	copper	copper	copper	copper	copper
Shield:	Spiral shielding	Spiral shielding	Spiral shielding	Spiral shielding	Spiral shielding
Line resistance:	<90 Ohm(s)	<90 Ohm(s)	<90 Ohm(s)	<90 Ohm(s)	<90 Ohm(s)
Capacitance:	45 pF/m	45 pF/m	45 pF/m	45 pF/m	45 pF/m
Jacket material:	PVC	PVC	PVC	PVC	PVC
Additional information:	Inner conductors shielded in pairs, AES/EBU-compliant	Inner conductors shielded in pairs, AES/EBU-compliant	Inner conductors shielded in pairs, AES/EBU-compliant	Inner conductors shielded in pairs, AES/EBU-compliant	Inner conductors shielded in pairs, AES/EBU-compliant

# BULK CABLES



## KSC##

### MULTICORE CABLE

Model name:	KSC04	KSC08	KSC12	KSC16	KSC20
Product type:	Multicore cable	Multicore cable	Multicore cable	Multicore cable	Multicore cable
Colour:	black	black	black	black	black
Overall diameter:	11.3 mm	14.8 mm	17.9 mm	20.1 mm	22.3 mm
Center conductor cross section:	0.22 mm <sup>2</sup>	0.22 mm <sup>2</sup>	0.22 mm <sup>2</sup>	0.22 mm <sup>2</sup>	0.22 mm <sup>2</sup>
Center conductor material:	Copper, tin-plated	Copper, tin-plated	Copper, tin-plated	Copper, tin-plated	Copper, tin-plated
Center conductor construction:	7 x 0.2 mm	7 x 0.2 mm	7 x 0.2 mm	7 x 0.2 mm	7 x 0.2 mm
Number of internal conductors:	8	16	24	32	40
Shield material:	Aluminium foil	Aluminium foil	Aluminium foil	Aluminium foil	Aluminium foil
Shield:	Wound shielding	Wound shielding	Wound shielding	Wound shielding	Wound shielding
Line resistance:	<87 Ohm(s)	<87 Ohm(s)	<87 Ohm(s)	<87 Ohm(s)	<87 Ohm(s)
Capacitance:	65 pF/m	65 pF/m	65 pF/m	65 pF/m	65 pF/m
Jacket material:	PVC	PVC	PVC	PVC	PVC
Additional information:	Inner conductors shielded in pairs, AES/EBU-compliant				

Model name:	KSC24	KSC32
Product type:	Multicore cable	Multicore cable
Colour:	black	black
Overall diameter:	24.9 mm	28.8 mm
Center conductor cross section:	0.22 mm <sup>2</sup>	0.22 mm <sup>2</sup>
Center conductor material:	Copper, tin-plated	Copper, tin-plated
Center conductor construction:	7 x 0.2 mm	7 x 0.2 mm
Number of internal conductors:	48	64
Shield material:	Aluminium foil	Aluminium foil
Shield:	Wound shielding	Wound shielding
Line resistance:	<87 Ohm(s)	<87 Ohm(s)
Capacitance:	65 pF/m	65 pF/m
Jacket material:	PVC	PVC
Additional information:		









## **CABLE DRUMS**

Our range of cable drums includes professional heavy-duty models made of powder coated steel and lightweight versions of unbreakable plastic with a large selection of pre-punched connector panels.

# CABLE DRUMS

NEW!

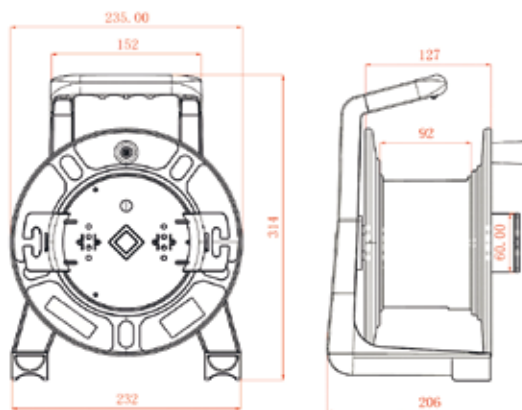

## 70224

RUGGED, LIGHTWEIGHT PROFESSIONAL CABLE DRUM

The AH 70224 cable drum is made of indestructible environmentally friendly plastic and ensures professional transport and storage of cables of all kinds. The sturdy, smooth-running design with ergonomic handle is equipped with a removable cable guide and parking brake and weighs only 1.2 kg.

## SPECIFICATIONS

Product type	Cable drum
Frame material	PC
Drum material	PE
Pedestal material	PP
Colour	black
Capacity	15 mm $\phi$ = 11 m
Capacity	3.0 mm $\phi$ = 317 m
Capacity	7.0 mm $\phi$ = 57 m
Weight	1,2 kg

# CABLE DRUMS



## 70224D1

ADAM HALL CABLES 70224 D 1 -  
FRONT PANEL FOR CABLE DRUM  
70224 WITH 1 X D-TYPE HOLE

Front panel made of black  
powder-coated metal for cable drum  
70224 with 1 x D-type hole.

- Product Type: front panel for cable drum
- Number of D-type Holes: 1
- Material: metal
- Surface: powder-coated
- Colour: black

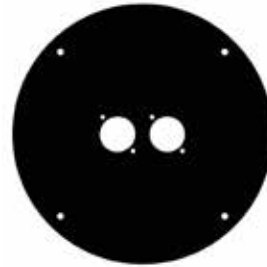

## 70224D2

ADAM HALL CABLES 70224 D 2 -  
FRONT PANEL FOR CABLE DRUM  
70224 WITH 2 X D-TYPE HOLE

Front panel made of black  
powder-coated metal for cable drum  
70224 with 2 x D-type hole.

- Product Type: front panel for cable drum
- Number of D-type Holes: 2
- Material: metal
- Surface: powder-coated
- Colour: black



**US**



**EU**



# CABLE DRUMS

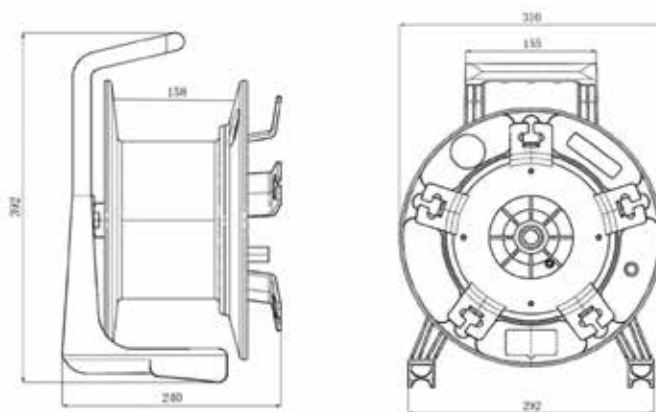

## 70225

RUGGED, LIGHTWEIGHT PROFESSIONAL CABLE DRUM

The AH 70225 cable drum is made of indestructible, environmentally friendly plastic and ensures regular, professional transport and storage of cables of all kinds. The sturdy, smooth-running design with ergonomic handle is equipped with a removable cable guide and parking brake and weighs only 1.8 kg.

## SPECIFICATIONS

Product type:	Cable drum
Frame material:	PC
Drum material:	PE
Pedestal material:	PP
Colour:	black
Capacity:	10 mm $\phi$ = 64 m
Capacity:	12 mm $\phi$ = 39 m
Capacity:	8 mm $\phi$ = 90 m
Capacity:	14 mm $\phi$ = 32 m
Capacity:	6.0 mm $\phi$ = 170 m
Capacity:	6.5 mm $\phi$ = 140 m

# CABLE DRUMS



## 70225D1

FRONT PANEL FOR CABLE DRUM 70225  
WITH 1 X D-TYPE HOLE

### SPECIFICATIONS

Product type:	front panel for cable drum
Number of D-type Holes:	1
Material:	metal
Surface:	powder coated
Colour:	black

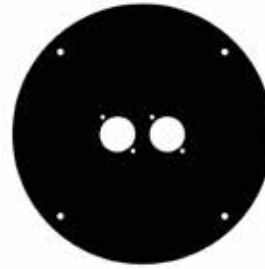

## 70225D2

FRONT PANEL FOR CABLE DRUM 70225  
WITH 2 X D-TYPE HOLES

### SPECIFICATIONS

Product type:	front panel for cable drum
Number of D-type Holes:	2
Material:	metal
Surface:	powder coated
Colour:	black

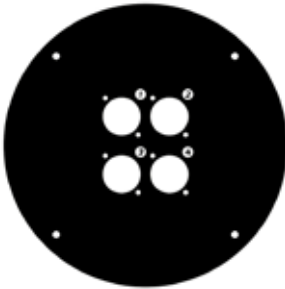

## 70225D4

FRONT PANEL FOR CABLE DRUM 70225  
WITH 4 X D-TYPE HOLES

### SPECIFICATIONS

Product type:	front panel for cable drum
Number of D-type Holes:	4
Material:	metal
Surface:	powder coated
Colour:	black

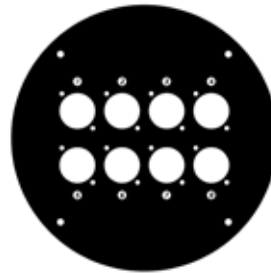

## 70225D8

FRONT PANEL FOR CABLE DRUM 70225  
WITH 8 X D-TYPE HOLES

### SPECIFICATIONS

Product type:	front panel for cable drum
Number of D-type Holes:	8
Material:	metal
Surface:	black
Colour:	black

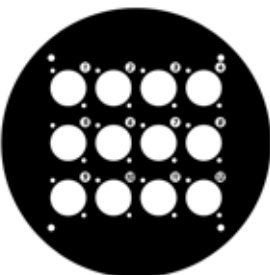

## 70225D12

FRONT PANEL FOR CABLE DRUM 70225  
WITH 12 X D-TYPE HOLE

### SPECIFICATIONS

Product type:	front panel for cable drum
Number of D-type Holes:	12
Material:	metal
Surface:	powder coated
Colour:	black

# CABLE DRUMS

NEW!

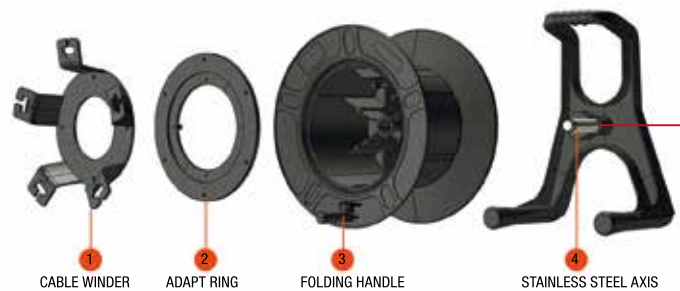
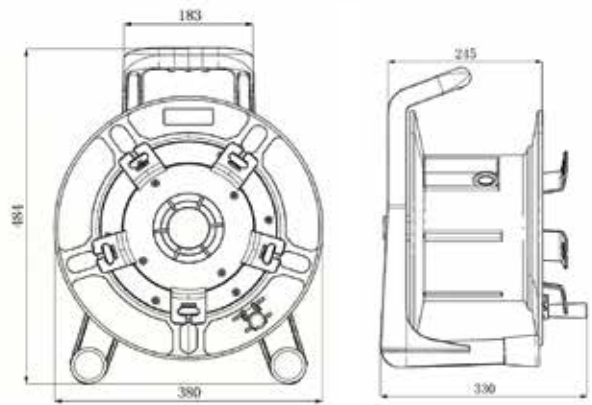

## 70226

RUGGED, LIGHTWEIGHT PROFESSIONAL CABLE DRUM

The AH 70226 cable drum is made of indestructible environmentally friendly plastic and ensures regular, professional transport and storage of cables of all kinds. The sturdy, smooth-running design with ergonomic handle is equipped with a removable cable guide and parking brake and weighs only 4.0 kg.

## SPECIFICATIONS

Product type	Cable drum
Frame material	PC
Drum material	PE
Pedestal material	PP
Colour	black
Capacity	15 mm $\phi$ = 43 m
Capacity	7.0 mm $\phi$ = 237 m
Capacity	3.0 mm $\phi$ = 1313 m
Weight	4 kg



# CABLE DRUMS

## ALSO FITTING

70225D1



70225D2



70225D4

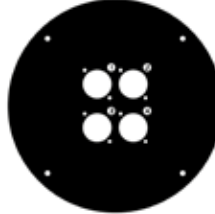

70225D8

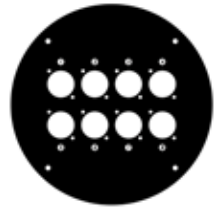

70225D12

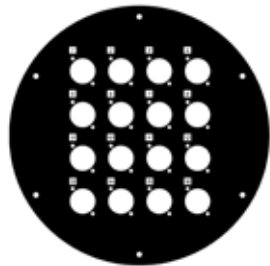
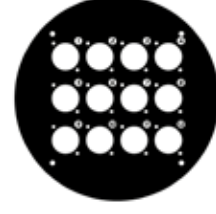

### 70226D16

FRONT PANEL MADE OF BLACK POWDER-COATED METAL FOR CABLE DRUM 70226 WITH 16 X D-TYPE HOLE.

#### SPECIFICATIONS

Product type	front panel for cable drum
Number of D-type Holes	16
Material	metal
Surface	powder coated
Colour	black

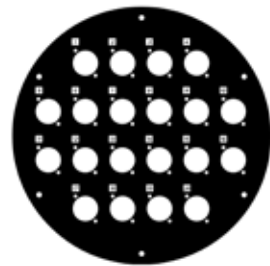

### 70226D20

FRONT PANEL MADE OF BLACK POWDER-COATED METAL FOR CABLE DRUM 70226 WITH 20 X D-TYPE HOLE.

#### SPECIFICATIONS

Product type	front panel for cable drum
Number of D-type Holes	20
Material	metal
Surface	powder coated
Colour	black

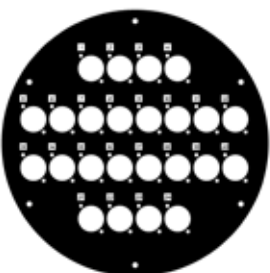

### 70226D24

FRONT PANEL MADE OF BLACK POWDER-COATED METAL FOR CABLE DRUM 70226 WITH 24 X D-TYPE HOLE.

#### SPECIFICATIONS

Product type	front panel for cable drum
Number of D-type Holes	24
Material	metal
Surface	powder coated
Colour	black

# CABLE DRUMS



## 70220

CABLE DRUM SMALL PLASTIC

### SPECIFICATIONS

Product type:	Cable drum	Removable crank:	no
Frame material:	steel	Total dimensions	
Frame surface:	powder coated	Width:	280 mm
Frame colour:	red	Height:	365 mm
Castor Wheels:	no	Depth:	180 mm
Drum material:	plastic	Additional information:	Soft plastic handle cover
Drum surface:	nature		
Drum colour:	black		
∅ drum core:	114 mm		
∅ drum max.:	270 mm		
Drum width:	90 - 120 mm		
Drum brake:	yes		



## 70230

CABLE DRUM IDENTICAL TO K28C30D

### SPECIFICATIONS

Product type:	Cable drum	Removable crank:	yes
Frame material:	steel	Total dimensions	
Frame surface:	powder coated	Width:	65 mm
Frame colour:	black	Height:	45 mm
Castor Wheels:	yes	Depth:	66 mm
Drum material:	steel	Additional information:	Including dummy plate and punched connector panel (24/8)
Drum surface:	powder coated		
Drum colour:	black		
∅ drum core:	250 mm		
∅ drum max.:	450 mm		
Drum width:	290 mm		
Drum brake:	yes		



## 70250

CABLE DRUM BLACK

### SPECIFICATIONS

Product type:	Cable drum	Removable crank:	yes
Frame material:	steel	Total dimensions	
Frame surface:	powder coated	Width:	540 mm
Frame colour:	black	Height:	460 mm
Castor Wheels:	no	Depth:	450 mm
Drum material:	steel	Additional information:	with divided drum
Drum surface:	powder coated		
Drum colour:	black		
∅ drum core:	150 mm		
∅ drum max.:	395 mm		
Drum width:	350/90 mm		
Drum brake:	yes		

# CABLE DRUMS



## 70260

CABLE DRUM BLACK

### SPECIFICATIONS

Product type:	Cable drum	Removable crank:	yes
Frame material:	steel	Total dimensions	
Frame surface:	powder coated	Width:	680 mm
Frame colour:	black	Height:	460 mm
Castor Wheels:	no	Depth:	450 mm
Drum material:	steel	Additional information:	with divided drum
Drum surface:	powder coated		
Drum colour:	black		
Ø drum core:	150 mm		
Ø drum max.:	395 mm		
Drum width:	490/90 mm		
Drum brake:	yes		



- 1
- 2
- 3
- 4
- 5
- 6
- 7
- 8
- 9
- 10
- 11
- 12



## **MULTICORE SYSTEMS**

Our ready-made multicore cable assemblies come in a wide variety of configurations and lengths up to 50 m. They are available on heavy-duty cable reels with connector panels or with stage box and fan ends.

# MULTICORE SYSTEMS

## K12C10

MULTICORE WITH STAGE BOX 12/0 10 M

### SPECIFICATIONS

Product type:	Multicore to stage box
Channels:	12
Length:	10 m
Colour:	black
Cable diameter:	14.6 mm
Conductor cross-section:	0.314 mm <sup>2</sup>
Connector 1 (built into drum / stage box):	XLR
Number of connectors connector 1:	12
Gender of connector 1:	female
Poles of connector 1:	3
Connector 2 (splice):	XLR
Number of connectors connector 2:	12
Gender of connector 2:	male
Poles of connector 2:	3
Model number connector 2:	Custom-made
Width:	235 mm
Height:	90 mm



## K20C15

MULTICORE WITH STAGE BOX 16/4 15 M

### SPECIFICATIONS

Product type:	Multicore to stage box
Channels:	20
Pin-out:	16/4
Length:	15 m
Colour:	black
Cable diameter:	20.2 mm
Conductor cross-section:	0.314 mm <sup>2</sup>
Connector 1-A (built into drum / stage box):	XLR
Number of connectors connector 1-A:	16
Gender of connector 1-A:	female
Poles of connector 1-A:	3
Contacts of connector 1-A:	Nickel-silver
Manufacturer of connector 1-A:	Adam Hall
Model number connector 1-A:	Custom-made
Connector 1-B (built into drum / stage box):	XLR
Number of connectors connector 1-B:	4
Gender of connector 1-B:	male
Poles of connector 1-B:	3
Contacts of connector 1-B:	Nickel-silver
Manufacturer of connector 1-B:	Adam Hall

Model number connector 1-B:	Custom-made
Connector 2-A (splice):	XLR
Number of connectors connector 2-A:	16
Gender of connector 2-A:	male
Poles of connector 2-A:	3
Contacts of connector 2-A:	Nickel-silver
Manufacturer of connector 2-A:	Adam Hall
Model number connector 2-A:	Custom-made
Connector 2-B (splice):	XLR
Number of connectors connector 2-B:	4
Gender of connector 2-B:	female
Poles of connector 2-B:	3
Contacts of connector 2-B:	Nickel-silver
Manufacturer of connector 2-B:	Adam Hall
Model number connector 2-B:	Custom-made
Width:	180 mm
Height:	75 mm
Depth:	335 mm



# MULTICORE SYSTEMS

## K20C30

MULTICORE WITH STAGE BOX 16/4 30 M

### SPECIFICATIONS

Product type:	Multicore to stage box
Channels:	20
Pin-out:	16/4
Length:	30 m
Colour:	black
Cable diameter:	19.8 m
Conductor cross-section:	0.314 mm <sup>2</sup>
Connector 1-A (built into drum / stage box):	XLR
Number of connectors connector 1-A:	16
Gender of connector 1-A:	female
Poles of connector 1-A:	3
Contacts of connector 1-A:	Nickel-silver
Manufacturer of connector 1-A:	Adam Hall
Model number connector 1-A:	Custom-made
Connector 1-B (built into drum / stage box):	XLR
Number of connectors connector 1-B:	4
Gender of connector 1-B:	male
Poles of connector 1-B:	3

Contacts of connector 1-B:	Nickel-silver
Manufacturer of connector 1-B:	Adam Hall
Model number connector 1-B:	Custom-made
Connector 2-A (splice):	XLR
Number of connectors connector 2-A:	16
Gender of connector 2-A:	male
Poles of connector 2-A:	3
Contacts of connector 2-A:	Nickel-silver
Manufacturer of connector 2-A:	Adam Hall
Model number connector 2-A:	Custom-made
Connector 2-B (splice):	XLR
Number of connectors connector 2-B:	4
Gender of connector 2-B:	female
Poles of connector 2-B:	3
Contacts of connector 2-B:	Nickel-silver
Manufacturer of connector 2-B:	Adam Hall
Model number connector 2-B:	Custom-made
Width:	180 mm
Height:	90 mm
Depth:	335 mm



## K20C30D

MULTICORE ON DRUM WITH STAGE BOX 16/4 30 M

### SPECIFICATIONS

Product type:	Multicore on Drum
Channels:	20
Pin-out:	16/4
Length:	30 m
Colour:	black
Cable diameter:	20.4 mm
Conductor cross-section:	0.314 mm <sup>2</sup>
Connector 1-A (built into drum / stage box):	XLR
Number of connectors connector 1-A:	16
Gender of connector 1-A:	female
Poles of connector 1-A:	3
Contacts of connector 1-A:	Nickel-silver
Manufacturer of connector 1-A:	Adam Hall
Model number connector 1-A:	Custom-made
Connector 1-B (built into drum / stage box):	XLR
Number of connectors connector 1-B:	4
Gender of connector 1-B:	male
Poles of connector 1-B:	3
Contacts of connector 1-B:	Nickel-silver
Manufacturer of connector 1-B:	Adam Hall

Model number connector 1-B:	Custom-made
Connector 2-A (splice):	XLR
Number of connectors connector 2-A:	16
Gender of connector 2-A:	male
Poles of connector 2-A:	3
Contacts of connector 2-A:	Nickel-silver
Manufacturer of connector 2-A:	Adam Hall
Model number connector 2-A:	Custom-made
Connector 2-B (splice):	XLR
Number of connectors connector 2-B:	4
Gender of connector 2-B:	female
Poles of connector 2-B:	3
Contacts of connector 2-B:	Nickel-silver
Manufacturer of connector 2-B:	Adam Hall
Model number connector 2-B:	Custom-made
Width:	630 mm
Height:	550 mm
Depth:	400 mm
Other features:	Castors for cable drum included





# MULTICORE SYSTEMS

## K20C50

MULTICORE WITH STAGE BOX 16/4 50 M

### SPECIFICATIONS

Product type:	Multicore to stage box
Channels:	20
Pin-out:	16/4
Length:	50 m
Colour:	black
Cable diameter:	20.2 mm
Conductor cross-section:	0.314 mm <sup>2</sup>
Connector 1-A (built into drum / stage box):	XLR
Number of connectors connector 1-A:	16
Gender of connector 1-A:	female
Poles of connector 1-A:	3
Contacts of connector 1-A:	Nickel-silver
Manufacturer of connector 1-A:	Adam Hall
Model number connector 1-A:	Custom-made
Connector 1-B (built into drum / stage box):	XLR
Number of connectors connector 1-B:	4
Gender of connector 1-B:	male
Poles of connector 1-B:	3

Contacts of connector 1-B:	Nickel-silver
Manufacturer of connector 1-B:	Adam Hall
Model number connector 1-B:	Custom-made
Connector 2-A (splice):	XLR
Number of connectors connector 2-A:	16
Gender of connector 2-A:	male
Poles of connector 2-A:	3
Contacts of connector 2-A:	Nickel-silver
Manufacturer of connector 2-A:	Adam Hall
Model number connector 2-A:	Custom-made
Connector 2-B (splice):	XLR
Number of connectors connector 2-B:	4
Gender of connector 2-B:	female
Poles of connector 2-B:	3
Contacts of connector 2-B:	Nickel-silver
Manufacturer of connector 2-B:	Adam Hall
Model number connector 2-B:	Custom-made
Width:	180 mm
Height:	75 mm
Depth:	335 mm



## K20C50D

MULTICORE ON DRUM WITH STAGE BOX 16/4 50 M

### SPECIFICATIONS

Product type	Multicore on Drum
Channels	20
Pin-out	16/4
Length	50 m
Colour	black
Cable diameter	20.2 mm
Conductor cross-section	0.314 mm <sup>2</sup>
Connector 1-A (built into drum / stage box)	XLR
Number of connectors connector 1-A	16
Gender of connector 1-A	female
Poles of connector 1-A	3
Contacts of connector 1-A	Nickel-silver
Manufacturer of connector 1-A	Adam Hall
Model number connector 1-A	Custom-made
Connector 1-B (built into drum / stage box)	XLR
Number of connectors connector 1-B	4
Gender of connector 1-B	male
Poles of connector 1-B	3
Contacts of connector 1-B	Nickel-silver
Manufacturer of connector 1-B	Adam Hall

Model number connector 1-B	Custom-made
Connector 2-A (splice)	XLR
Number of connectors connector 2-A	16
Gender of connector 2-A	male
Poles of connector 2-A	3
Contacts of connector 2-A	Nickel-silver
Manufacturer of connector 2-A	Adam Hall
Model number connector 2-A	Custom-made
Connector 2-B (splice)	XLR
Number of connectors connector 2-B	4
Gender of connector 2-B	female
Poles of connector 2-B	3
Contacts of connector 2-B	Nickel-silver
Manufacturer of connector 2-B	Adam Hall
Model number connector 2-B	Custom-made
Width	545 mm
Height	620 mm
Depth	390 mm
Other features	Castors for cable drum included



# MULTICORE SYSTEMS

## K28C30

MULTICORE WITH STAGE BOX 24/4 30 M

### SPECIFICATIONS

Product type:	Multicore to stage box
Channels:	28
Pin-out:	24/4
Length:	30 m
Colour:	black
Cable diameter:	23.6 mm
Conductor cross-section:	0.314 mm <sup>2</sup>
Connector 1-A (built into drum / stage box):	XLR
Number of connectors connector 1-A:	24
Gender of connector 1-A:	female
Poles of connector 1-A:	3
Contacts of connector 1-A:	Nickel-silver
Manufacturer of connector 1-A:	Adam Hall
Model number connector 1-A:	Custom-made
Connector 1-B (built into drum / stage box):	XLR
Number of connectors connector 1-B:	4
Gender of connector 1-B:	male
Poles of connector 1-B:	3

Contacts of connector 1-B:	Nickel-silver
Manufacturer of connector 1-B:	Adam Hall
Model number connector 1-B:	Custom-made
Connector 2-A (splice):	XLR
Number of connectors connector 2-A:	24
Gender of connector 2-A:	male
Poles of connector 2-A:	3
Contacts of connector 2-A:	Nickel-silver
Manufacturer of connector 2-A:	Adam Hall
Model number connector 2-A:	Custom-made
Connector 2-B (splice):	XLR
Number of connectors connector 2-B:	4
Gender of connector 2-B:	female
Poles of connector 2-B:	3
Contacts of connector 2-B:	Nickel-silver
Manufacturer of connector 2-B:	Adam Hall
Model number connector 2-B:	Custom-made
Width:	180 mm
Height:	90 mm
Depth:	385 mm



## K28C30D

MULTICORE ON DRUM WITH STAGE BOX 24/4 30 M

### SPECIFICATIONS

Product type:	Multicore on Drum
Channels:	28
Pin-out:	24/4
Length:	30 m
Colour:	black
Cable diameter:	23.8 mm
Conductor cross-section:	0.314 mm <sup>2</sup>
Connector 1-A (built into drum / stage box):	XLR
Number of connectors connector 1-A:	24
Gender of connector 1-A:	female
Poles of connector 1-A:	3
Contacts of connector 1-A:	Nickel-silver
Manufacturer of connector 1-A:	Adam Hall
Model number connector 1-A:	Custom-made
Connector 1-B (built into drum / stage box):	XLR
Number of connectors connector 1-B:	4
Gender of connector 1-B:	male
Poles of connector 1-B:	3
Contacts of connector 1-B:	Nickel-silver
Manufacturer of connector 1-B:	Adam Hall

Model number connector 1-B:	Custom-made
Connector 2-A (splice):	XLR
Number of connectors connector 2-A:	24
Gender of connector 2-A:	male
Poles of connector 2-A:	3
Contacts of connector 2-A:	Nickel-silver
Manufacturer of connector 2-A:	Adam Hall
Model number connector 2-A:	Custom-made
Connector 2-B (splice):	XLR
Number of connectors connector 2-B:	4
Gender of connector 2-B:	female
Poles of connector 2-B:	3
Contacts of connector 2-B:	Nickel-silver
Manufacturer of connector 2-B:	Adam Hall
Model number connector 2-B:	Custom-made
Width:	630 mm
Height:	550 mm
Depth:	400 mm
Other features:	Castors for cable drum included



# MULTICORE SYSTEMS

## K28C50

MULTICORE WITH STAGE BOX 24/4 50 M

### SPECIFICATIONS

Product type:	Multicore to stage box
Channels:	28
Pin-out:	24/4
Length:	50 m
Colour:	black
Cable diameter:	23.2 mm
Conductor cross-section:	0.314 mm <sup>2</sup>
Connector 1-A (built into drum / stage box):	XLR
Number of connectors connector 1-A:	24
Gender of connector 1-A:	female
Poles of connector 1-A:	3
Contacts of connector 1-A:	Nickel-silver
Manufacturer of connector 1-A:	Adam Hall
Model number connector 1-A:	Custom-made
Connector 1-B (built into drum / stage box):	XLR
Number of connectors connector 1-B:	4
Gender of connector 1-B:	male
Poles of connector 1-B:	3

Contacts of connector 1-B:	Nickel-silver
Manufacturer of connector 1-B:	Adam Hall
Model number connector 1-B:	Custom-made
Connector 2-A (splice):	XLR
Number of connectors connector 2-A:	24
Gender of connector 2-A:	male
Poles of connector 2-A:	3
Contacts of connector 2-A:	Nickel-silver
Manufacturer of connector 2-A:	Adam Hall
Model number connector 2-A:	Custom-made
Connector 2-B (splice):	XLR
Number of connectors connector 2-B:	4
Gender of connector 2-B:	female
Poles of connector 2-B:	3
Contacts of connector 2-B:	Nickel-silver
Manufacturer of connector 2-B:	Adam Hall
Model number connector 2-B:	Custom-made
Width:	180 mm
Height:	75 mm
Depth:	385 mm



## K28C50D

MULTICORE ON DRUM WITH STAGE BOX 24/4 50 M

### SPECIFICATIONS

Product type:	Multicore on Drum
Channels:	28
Pin-out:	24/4
Length:	50 m
Colour:	black
Cable diameter:	23.2 mm
Conductor cross-section:	0.314 mm <sup>2</sup>
Connector 1-A (built into drum / stage box):	XLR
Number of connectors connector 1-A:	24
Gender of connector 1-A:	female
Poles of connector 1-A:	3
Contacts of connector 1-A:	Nickel-silver
Manufacturer of connector 1-A:	Adam Hall
Model number connector 1-A:	Custom-made
Connector 1-B (built into drum / stage box):	XLR
Number of connectors connector 1-B:	4
Gender of connector 1-B:	male
Poles of connector 1-B:	3
Contacts of connector 1-B:	Nickel-silver
Manufacturer of connector 1-B:	Adam Hall

Model number connector 1-B:	Custom-made
Connector 2-A (splice):	XLR
Number of connectors connector 2-A:	24
Gender of connector 2-A:	male
Poles of connector 2-A:	3
Contacts of connector 2-A:	Nickel-silver
Manufacturer of connector 2-A:	Adam Hall
Model number connector 2-A:	Custom-made
Connector 2-B (splice):	XLR
Number of connectors connector 2-B:	4
Gender of connector 2-B:	female
Poles of connector 2-B:	3
Contacts of connector 2-B:	Nickel-silver
Manufacturer of connector 2-B:	Adam Hall
Model number connector 2-B:	Custom-made
Width:	545 mm
Height:	620 mm
Depth:	390 mm
Other features:	Castors for cable drum included



# MULTICORE SYSTEMS

## K32C30

MULTICORE WITH STAGE BOX 24/8 30 M

### SPECIFICATIONS

Product type:	Multicore to stage box
Channels:	32
Pin-out:	24/8
Length:	30 m
Colour:	black
Cable diameter:	24.7 mm
Conductor cross-section:	0.314 mm <sup>2</sup>
Connector 1-A (built into drum / stage box):	XLR
Number of connectors connector 1-A:	24
Gender of connector 1-A:	female
Poles of connector 1-A:	3
Contacts of connector 1-A:	Nickel-silver
Manufacturer of connector 1-A:	Adam Hall
Model number connector 1-A:	Custom-made
Connector 1-B (built into drum / stage box):	XLR
Number of connectors connector 1-B:	8
Gender of connector 1-B:	male
Poles of connector 1-B:	3

Contacts of connector 1-B:	Nickel-silver
Manufacturer of connector 1-B:	Adam Hall
Model number connector 1-B:	Custom-made
Connector 2-A (splice):	XLR
Number of connectors connector 2-A:	24
Gender of connector 2-A:	male
Poles of connector 2-A:	3
Contacts of connector 2-A:	Nickel-silver
Manufacturer of connector 2-A:	Adam Hall
Model number connector 2-A:	Custom-made
Connector 2-B (splice):	XLR
Number of connectors connector 2-B:	8
Gender of connector 2-B:	female
Poles of connector 2-B:	3
Contacts of connector 2-B:	Nickel-silver
Manufacturer of connector 2-B:	Adam Hall
Model number connector 2-B:	Custom-made
Width:	180 mm
Height:	90 mm
Depth:	385 mm



## K32C30D

MULTICORE ON DRUM WITH STAGE BOX 24/8 30 M

### SPECIFICATIONS

Product type:	Multicore on Drum
Channels:	32
Pin-out:	24/8
Length:	30 m
Colour:	black
Cable diameter:	25.2 mm
Conductor cross-section:	0.314 mm <sup>2</sup>
Connector 1-A (built into drum / stage box):	XLR
Number of connectors connector 1-A:	24
Gender of connector 1-A:	female
Poles of connector 1-A:	3
Contacts of connector 1-A:	Nickel-silver
Manufacturer of connector 1-A:	Adam Hall
Model number connector 1-A:	Custom-made
Connector 1-B (built into drum / stage box):	XLR
Number of connectors connector 1-B:	8
Gender of connector 1-B:	male
Poles of connector 1-B:	3
Contacts of connector 1-B:	Nickel-silver
Manufacturer of connector 1-B:	Adam Hall

Model number connector 1-B:	Custom-made
Connector 2-A (splice):	XLR
Number of connectors connector 2-A:	24
Gender of connector 2-A:	male
Poles of connector 2-A:	3
Contacts of connector 2-A:	Nickel-silver
Manufacturer of connector 2-A:	Adam Hall
Model number connector 2-A:	Custom-made
Connector 2-B (splice):	XLR
Number of connectors connector 2-B:	8
Gender of connector 2-B:	female
Poles of connector 2-B:	3
Contacts of connector 2-B:	Nickel-silver
Manufacturer of connector 2-B:	Adam Hall
Model number connector 2-B:	Custom-made
Width:	630 mm
Height:	550 mm
Depth:	400 mm
Other features:	Castors for cable drum included



# MULTICORE SYSTEMS

## K32C50

MULTICORE WITH STAGE BOX 24/8 50 M

### SPECIFICATIONS

Product type:	Multicore to stage box
Channels:	32
Pin-out:	24/8
Length:	50 m
Colour:	black
Cable diameter:	26 mm
Conductor cross-section:	0.314 mm <sup>2</sup>
Connector 1-A (built into drum / stage box):	XLR
Number of connectors connector 1-A:	24
Gender of connector 1-A:	male
Poles of connector 1-A:	3
Contacts of connector 1-A:	Nickel-silver
Manufacturer of connector 1-A:	Adam Hall
Model number connector 1-A:	Custom-made
Connector 1-B (built into drum / stage box):	XLR
Number of connectors connector 1-B:	8
Gender of connector 1-B:	male
Poles of connector 1-B:	3

Contacts of connector 1-B:	Nickel-silver
Manufacturer of connector 1-B:	Adam Hall
Model number connector 1-B:	Custom-made
Connector 2-A (splice):	XLR
Number of connectors connector 2-A:	24
Gender of connector 2-A:	male
Poles of connector 2-A:	3
Contacts of connector 2-A:	Nickel-silver
Manufacturer of connector 2-A:	Neutrik
Model number connector 2-A:	Custom-made
Connector 2-B (splice):	XLR
Number of connectors connector 2-B:	8
Gender of connector 2-B:	female
Poles of connector 2-B:	3
Contacts of connector 2-B:	Nickel-silver
Manufacturer of connector 2-B:	Adam Hall
Model number connector 2-B:	Custom-made
Width:	385 mm
Height:	75 mm
Depth:	180 mm



## K32C50D

MULTICORE ON DRUM WITH STAGE BOX 24/8 50 M

### SPECIFICATIONS

Product type:	Multicore to stage box
Channels:	32
Pin-out:	24/8
Length:	50 m
Colour:	black
Cable diameter:	24.7 mm
Conductor cross-section:	0.314 mm <sup>2</sup>
Connector 1-A (built into drum / stage box):	XLR
Number of connectors connector 1-A:	24
Gender of connector 1-A:	female
Poles of connector 1-A:	3
Contacts of connector 1-A:	Nickel-silver
Manufacturer of connector 1-A:	Adam Hall
Model number connector 1-A:	Custom-made
Connector 1-B (built into drum / stage box):	XLR
Number of connectors connector 1-B:	8
Gender of connector 1-B:	male
Poles of connector 1-B:	3
Contacts of connector 1-B:	Nickel-silver
Manufacturer of connector 1-B:	Adam Hall

Model number connector 1-B:	Custom-made
Connector 2-A (splice):	XLR
Number of connectors connector 2-A:	24
Gender of connector 2-A:	female
Poles of connector 2-A:	3
Contacts of connector 2-A:	Nickel-silver
Manufacturer of connector 2-A:	Adam Hall
Model number connector 2-A:	Custom-made
Connector 2-B (splice):	XLR
Number of connectors connector 2-B:	8
Gender of connector 2-B:	female
Poles of connector 2-B:	3
Contacts of connector 2-B:	Nickel-silver
Manufacturer of connector 2-B:	Adam Hall
Model number connector 2-B:	Custom-made
Width:	630 mm
Height:	400 mm
Depth:	550 mm
Other features:	Castors for cable drum included



# MULTICORE SYSTEMS

## K40C30

MULTICORE WITH STAGE BOX 32/8 30 M

### SPECIFICATIONS

Product type:	Multicore to stage box
Channels:	40
Pin-out:	32/8
Length:	30 m
Colour:	black
Cable diameter:	28 mm
Conductor cross-section:	0.314 mm <sup>2</sup>
Connector 1-A (built into drum / stage box):	XLR
Number of connectors connector 1-A:	32
Gender of connector 1-A:	male
Poles of connector 1-A:	3
Contacts of connector 1-A:	Nickel-silver
Manufacturer of connector 1-A:	Adam Hall
Model number connector 1-A:	Custom-made
Connector 1-B (built into drum / stage box):	XLR
Number of connectors connector 1-B:	8
Gender of connector 1-B:	female
Poles of connector 1-B:	3

Contacts of connector 1-B:	Nickel-silver
Manufacturer of connector 1-B:	Adam Hall
Model number connector 1-B:	Custom-made
Connector 2-A (splice):	XLR
Number of connectors connector 2-A:	32
Gender of connector 2-A:	female
Poles of connector 2-A:	3
Contacts of connector 2-A:	Nickel-silver
Manufacturer of connector 2-A:	Adam Hall
Model number connector 2-A:	Custom-made
Connector 2-B (splice):	XLR
Number of connectors connector 2-B:	8
Gender of connector 2-B:	male
Poles of connector 2-B:	3
Contacts of connector 2-B:	Nickel-silver
Manufacturer of connector 2-B:	Adam Hall
Model number connector 2-B:	Custom-made
Width:	460 mm
Height:	75 mm
Depth:	180 mm

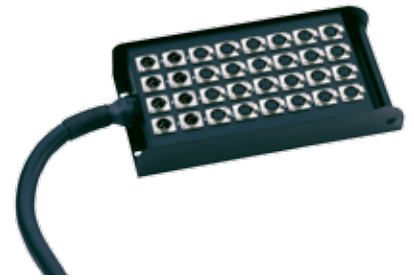

## K40C50

MULTICORE WITH STAGE BOX 32/8 50 M

### SPECIFICATIONS

Product type:	Multicore to stage box
Channels:	40
Pin-out:	32/8
Length:	50 m
Colour:	black
Cable diameter:	28 mm
Conductor cross-section:	0.314 mm <sup>2</sup>
Connector 1-A (built into drum / stage box):	XLR
Number of connectors connector 1-A:	32
Gender of connector 1-A:	male
Poles of connector 1-A:	3
Contacts of connector 1-A:	Nickel-silver
Manufacturer of connector 1-A:	Adam Hall
Model number connector 1-A:	Custom-made
Connector 1-B (built into drum / stage box):	XLR
Number of connectors connector 1-B:	8
Gender of connector 1-B:	female
Poles of connector 1-B:	3
Contacts of connector 1-B:	Nickel-silver
Manufacturer of connector 1-B:	Adam Hall

Model number connector 1-B:	Custom-made
Connector 2-A (splice):	XLR
Number of connectors connector 2-A:	32
Gender of connector 2-A:	female
Poles of connector 2-A:	3
Contacts of connector 2-A:	Nickel-silver
Manufacturer of connector 2-A:	Adam Hall
Model number connector 2-A:	Custom-made
Connector 2-B (splice):	XLR
Number of connectors connector 2-B:	8
Gender of connector 2-B:	male
Poles of connector 2-B:	3
Contacts of connector 2-B:	Nickel-silver
Manufacturer of connector 2-B:	Adam Hall
Model number connector 2-B:	Custom-made
Width:	460 mm
Height:	75 mm
Depth:	180 mm





# MULTICORE SYSTEMS

## K40C50D

MULTICORE ON DRUM WITH STAGE BOX 32/8 50 M

### SPECIFICATIONS

Product type:	Multicore on Drum
Channels:	40
Pin-out:	32/8
Length:	50 m
Colour:	black
Cable diameter:	28 mm
Conductor cross-section:	0.314 mm <sup>2</sup>
Connector 1-A (built into drum / stage box):	XLR
Number of connectors connector 1-A:	32
Gender of connector 1-A:	female
Poles of connector 1-A:	3
Contacts of connector 1-A:	Nickel-silver
Manufacturer of connector 1-A:	Adam Hall
Model number connector 1-A:	Custom-made
Connector 1-B (built into drum / stage box):	XLR
Number of connectors connector 1-B:	8
Gender of connector 1-B:	male
Poles of connector 1-B:	3
Contacts of connector 1-B:	Nickel-silver

Manufacturer of connector 1-B:	Adam Hall
Model number connector 1-B:	Custom-made
Connector 2-A (splice):	XLR
Number of connectors connector 2-A:	32
Gender of connector 2-A:	male
Poles of connector 2-A:	3
Contacts of connector 2-A:	Nickel-silver
Manufacturer of connector 2-A:	Adam Hall
Model number connector 2-A:	Custom-made
Connector 2-B (splice):	XLR
Number of connectors connector 2-B:	8
Gender of connector 2-B:	female
Poles of connector 2-B:	3
Contacts of connector 2-B:	Nickel-silver
Manufacturer of connector 2-B:	Adam Hall
Model number connector 2-B:	Custom-made
Width:	630 mm
Height:	550 mm
Depth:	400 mm
Other features:	Castors for cable drum included



## K8C10

STAGE BOX 8/0 10 M

### SPECIFICATIONS

Product type:	Multicore to stage box
Channels:	8
Length:	10 m
Colour:	black
Cable diameter:	13 mm
Conductor cross-section:	0.314 mm <sup>2</sup>
Connector 1 (built into drum / stage box):	XLR
Number of connectors connector 1:	8
Gender of connector 1:	female
Poles of connector 1:	3
Connector 2 (splice):	XLR
Number of connectors connector 2:	8
Gender of connector 2:	male
Poles of connector 2:	3
Model number connector 2:	Custom-made
Width:	100 mm
Height:	90 mm
Depth:	325 mm





# MULTICORE SYSTEMS

## K40C30

MULTICORE WITH STAGE BOX 32/8 30 M

### SPECIFICATIONS

Product type:	Multicore to stage box
Channels:	40
Pin-out:	32/8
Length:	30 m
Colour:	black
Cable diameter:	28 mm
Conductor cross-section:	0.314 mm <sup>2</sup>
Connector 1-A (built into drum / stage box):	XLR
Number of connectors connector 1-A:	32
Gender of connector 1-A:	male
Poles of connector 1-A:	3
Contacts of connector 1-A:	Nickel-silver
Manufacturer of connector 1-A:	Adam Hall
Model number connector 1-A:	Custom-made
Connector 1-B (built into drum / stage box):	XLR
Number of connectors connector 1-B:	8
Gender of connector 1-B:	female
Poles of connector 1-B:	3

Contacts of connector 1-B:	Nickel-silver
Manufacturer of connector 1-B:	Adam Hall
Model number connector 1-B:	Custom-made
Connector 2-A (splice):	XLR
Number of connectors connector 2-A:	32
Gender of connector 2-A:	female
Poles of connector 2-A:	3
Contacts of connector 2-A:	Nickel-silver
Manufacturer of connector 2-A:	Adam Hall
Model number connector 2-A:	Custom-made
Connector 2-B (splice):	XLR
Number of connectors connector 2-B:	8
Gender of connector 2-B:	male
Poles of connector 2-B:	3
Contacts of connector 2-B:	Nickel-silver
Manufacturer of connector 2-B:	Adam Hall
Model number connector 2-B:	Custom-made
Width:	460 mm
Height:	75 mm
Depth:	180 mm

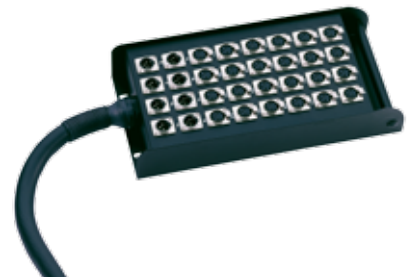

## K40C50

MULTICORE WITH STAGE BOX 32/8 50 M

### SPECIFICATIONS

Product type:	Multicore to stage box
Channels:	40
Pin-out:	32/8
Length:	50 m
Colour:	black
Cable diameter:	28 mm
Conductor cross-section:	0.314 mm <sup>2</sup>
Connector 1-A (built into drum / stage box):	XLR
Number of connectors connector 1-A:	32
Gender of connector 1-A:	male
Poles of connector 1-A:	3
Contacts of connector 1-A:	Nickel-silver
Manufacturer of connector 1-A:	Adam Hall
Model number connector 1-A:	Custom-made
Connector 1-B (built into drum / stage box):	XLR
Number of connectors connector 1-B:	8
Gender of connector 1-B:	female
Poles of connector 1-B:	3
Contacts of connector 1-B:	Nickel-silver
Manufacturer of connector 1-B:	Adam Hall

Model number connector 1-B:	Custom-made
Connector 2-A (splice):	XLR
Number of connectors connector 2-A:	32
Gender of connector 2-A:	female
Poles of connector 2-A:	3
Contacts of connector 2-A:	Nickel-silver
Manufacturer of connector 2-A:	Adam Hall
Model number connector 2-A:	Custom-made
Connector 2-B (splice):	XLR
Number of connectors connector 2-B:	8
Gender of connector 2-B:	male
Poles of connector 2-B:	3
Contacts of connector 2-B:	Nickel-silver
Manufacturer of connector 2-B:	Adam Hall
Model number connector 2-B:	Custom-made
Width:	460 mm
Height:	75 mm
Depth:	180 mm



# MULTICORE SYSTEMS

## K8C15P

STAGE BOX 8/0 15 M

### SPECIFICATIONS

Product type:	Multicore to stage box
Channels:	8
Length:	15 m
Colour:	black
Cable diameter:	13 mm
Conductor cross-section:	0.314 mm <sup>2</sup>
Connector 1 (built into drum / stage box):	XLR
Number of connectors connector 1:	8
Gender of connector 1:	female
Poles of connector 1:	3
Connector 2 (splice):	XLR
Number of connectors connector 2:	8
Gender of connector 2:	male
Poles of connector 2:	3
Model number connector 2:	Custom-made
Width:	140 mm
Height:	80 mm
Depth:	130 mm



## K40C50D

MULTICORE ON DRUM WITH STAGE BOX 32/8 50 M

### SPECIFICATIONS

Product type:	Multicore on Drum
Channels:	40
Pin-out:	32/8
Length:	50 m
Colour:	black
Cable diameter:	28 mm
Conductor cross-section:	0.314 mm <sup>2</sup>
Connector 1-A (built into drum / stage box):	XLR
Number of connectors connector 1-A:	32
Gender of connector 1-A:	female
Poles of connector 1-A:	3
Contacts of connector 1-A:	Nickel-silver
Manufacturer of connector 1-A:	Adam Hall
Model number connector 1-A:	Custom-made
Connector 1-B (built into drum / stage box):	XLR
Number of connectors connector 1-B:	8
Gender of connector 1-B:	male
Poles of connector 1-B:	3
Contacts of connector 1-B:	Nickel-silver
Manufacturer of connector 1-B:	Adam Hall

Model number connector 1-B:	Custom-made
Connector 2-A (splice):	XLR
Number of connectors connector 2-A:	32
Gender of connector 2-A:	male
Poles of connector 2-A:	3
Contacts of connector 2-A:	Nickel-silver
Manufacturer of connector 2-A:	Adam Hall
Model number connector 2-A:	Custom-made
Connector 2-B (splice):	XLR
Number of connectors connector 2-B:	8
Gender of connector 2-B:	female
Poles of connector 2-B:	3
Contacts of connector 2-B:	Nickel-silver
Manufacturer of connector 2-B:	Adam Hall
Model number connector 2-B:	Custom-made
Width:	630 mm
Height:	550 mm
Depth:	400 mm
Other features:	Castors for cable drum included

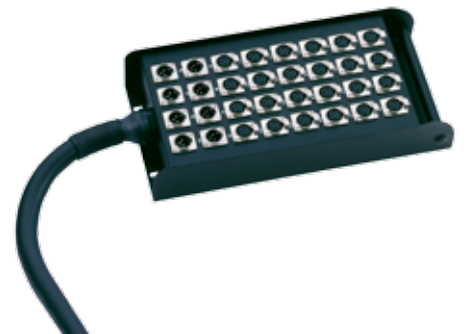

## K3CDMC8015

3-STAR 15 M 8/0-CHANNEL AUDIO SNAKE REEL

### SPECIFICATIONS

Product type:	Multicore Audio Cable
Colour:	black
Overall diameter:	14 mm +/- 0.2 mm
Jacket material:	PVS
AWG:	26
cross section:	0.14 mm <sup>2</sup>
Insulation:	PE 1,1 mm
Composition of conductor:	18 x 0.10 mm, bare cooper
Number of inner conductors:	8 x 2
Shielding:	AL/PT-foil + drain wire with 7 x 0,18mm tin plated copper
Conductor resistance:	127 Ω/km
Capacitance Cond./Cond.:	52 pF/m
Capacitance Cond./Shield.:	89 pF/m
Insulation Resistance:	> 1 GΩ
Working Temperature:	-20° to +70°
Surge Impedance:	100 ohm



## K3CDMC6215

3-STAR 15 M 6/2-CHANNEL AUDIO SNAKE REEL

### SPECIFICATIONS

Product type:	Multicore Audio Cable
Colour:	black
Overall diameter:	14 mm +/- 0.2 mm
Jacket material:	PVS
AWG:	26
cross section:	0.14 mm <sup>2</sup>
Insulation:	PE 1,1 mm
Composition of conductor:	18 x 0.10 mm, bare cooper
Number of inner conductors:	8 x 2
Shielding:	AL/PT-foil + drain wire with 7 x 0,18mm tin plated copper
Conductor resistance:	127 Ω/km
Capacitance Cond./Cond.:	52 pF/m
Capacitance Cond./Shield.:	89 pF/m
Insulation Resistance:	> 1 GΩ
Working Temperature:	-20° to +70°
Surge Impedance:	100 ohm







## **POWER CORDS & EXTENSIONS**

This section includes our range of standard IEC power cords, extension cords from 50 cm to 10 m length, IP44 rated extension cords, powerCON link cables and combination power and 3-pin XLR audio cables.

# POWER CORDS & EXTENSIONS

## 8101KA##

POWER CORD CEE 7/7 - C13

### SPECIFICATIONS

Product type:	Power cord
Type:	Power Cord
Colour:	black
Cable type:	H05VV-F
Center conductor cross section:	3 x 0.75 mm <sup>2</sup>
Connector 1:	CEE 7/7
Connector 2:	C13

Article No.	Length
8101KA0050	0.5 m
8101KA0100	1 m
8101KA0200	2 m
8101KA0300	3 m
8101KA0500	5 m



## 8101KB1000

POWER CORD CEE 7/7 - C13 10 M

### SPECIFICATIONS

Product type:	Power cord
Type:	Power Cord
Length:	10 m
Colour:	black
Cable type:	H05VV-F
Center conductor cross section:	3 x 1.5 mm <sup>2</sup>
Connector 2:	CEE 7/7
Length:	C13



## 8101KB##GB

POWER CORD BS1363/A (UK) - C13

### SPECIFICATIONS

Product type:	Power cord
Type:	Power Cord
Colour:	black
Cable type:	H05VV-F
Center conductor cross section:	3 x 1.0 mm <sup>2</sup>
Connector 2:	C13
Length:	3 m

Article No.	Length
8101KB0200GB	2 m
8101KB0300GB	3 m



# POWER CORDS & EXTENSIONS

## 8101KC##

EXTENSION CABLE C13 - C14

### SPECIFICATIONS

Product type:	Power cord
Type:	Extension Cable
Colour:	black
Cable type:	H05VV-F
Center conductor cross section:	3 x 0.75 mm <sup>2</sup>
Connector 1:	C13
Connector 2:	C14

Article No.	Lenght
8101KC0050	0.5 m
8101KC0100	1 m
8101KC0300	3 m
8101KC0500	5 m



## 8101KD##

EXTENSION CABLE C13 - C14

### SPECIFICATIONS

Product type:	Power cord
Type:	Extension Cable
Colour:	black
Cable type:	H05VV-F
Center conductor cross section:	3 x 1.0 mm <sup>2</sup>
Connector 1:	C13
Connector 2:	C14

Article No.	Lenght
8101KD0100	1 m
8101KD0300	3 m
8101KD0500	5 m



## 8101KF##

EXTENSION CABLE CEE 7/7 IP44 - CEE 7 IP44

### SPECIFICATIONS

Product type:	Power cord
Type:	Extension Cable
Colour:	black
Cable type:	H07RNF
Center conductor cross section:	3 x 1.5 mm <sup>2</sup>
Connector 1:	CEE 7/7 (IP44)
Connector 2:	CEE 7/7 (IP44)

Article No.	Lenght
8101KF0150	1.5 m
8101KF0300	3 m
8101KF0500	5 m
8101KF1000	10 m
8101KF1500	15 m
8101KF2000	20 m





# POWER CORDS & EXTENSIONS

## 8101KG##

EXTENSION CABLE CEE 7/7 IP44 - CEE 7 IP44

### SPECIFICATIONS

Product type:	Power cord	<b>Article No.</b>	<b>Lenght</b>
Type:	Extension Cable	8101KG0300	3 m
Colour:	black	8101KG0500	5 m
Cable type:	H07RNF	8101KG1000	10 m
Center conductor cross section:	3 x 2.5 mm <sup>2</sup>	8101KG1500	15 m
Connector 1:	CEE 7/7 (IP44)	8101KG2000	20 m
Connector 2:	CEE 7/7 (IP44)		



## 8101KI##

POWER CORD CEE 7 IP44 - C14

### SPECIFICATIONS

Product type:	Power cord	<b>Article No.</b>	<b>Lenght</b>
Type:	Power Cord	8101KI0050	0.5 m
Colour:	black	8101KI0100	1 m
Cable type:	H05VV-F		
Center conductor cross section:	3 x 1.0 mm <sup>2</sup>		
Connector 1:	CEE 7/7 (IP44)		
Connector 2:	C13		



## KSCP3

CONVERTER SAFETY PLUG /UK BLACK 13 A

### SPECIFICATIONS

Product type:	Converter plug
Colour:	black
Connector 1:	13 A UK Plug
Connector 2:	CEE Safety Plug
Voltage:	240 V / 50 Hz
Current:	13 A
Max load:	3000 W
Fuse:	3, 5, 10 & 13 A BS1362
Material:	Thermoplastic polypropylene cadmium-free
Diameter:	26 mm



# POWER CORDS & EXTENSIONS

## KSFCP

CONVERTER PLUG EURO/UK BLACK 5 A

### SPECIFICATIONS

Product type:	Converter plug
Colour:	black
Connector 1:	5 A UK Plug
Connector 2:	CEE 7 Euro Plug
Voltage:	250 V / 50 Hz
Current:	8 A
Max load:	2000 W
Fuse:	3, 5, 10 A BSI362
Material:	Thermoplastic Polypropylene



## KCCAB400##

POWER AND MICROPHONE CABLE EARTHING CONTACT & XLR FEMALE TO EURO POWER & XLR MALE

### SPECIFICATIONS

Product type:	Combination Cable	Article No.	Lenght
Cable designation:	KCPAC50	KCCAB4005	5 m
Colour:	black	KCCAB40010	10 m
Overall diameter:	14 mm	KCCAB40015	15 m
Jacket material:	PVC	KCCAB40020	20 m
Connector 1-A:	Earthing contact Type E+F (CEE 7/7)		
Gender of connector 1-A:	male		
Poles of connector 1-A:	3		
Connector 1-B:	XLR		
Gender of connector 1-B:	female		
Poles of connector 1-B:	3		
Connector 2-A:	Non-heating appliances		
Gender of connector 2-A:	female		
Poles of connector 2-A:	3		
Connector 2-B:	XLR		
Gender of connector 2-B:	male		
Poles of connector 2-B:	3		
Inner conductor 1 cross-section:	1 mm <sup>2</sup>		
Inner conductor 1 material:	copper		
Inner conductor 1 construction:	58 x 0.15 mm		
Number of inner conductors 1:	3		
Inner conductor 2 cross-section:	0.125 mm <sup>2</sup>		
Inner conductor 2 material:	copper		
Inner conductor 2 construction:	7 x 0.15 mm		
Number of inner conductors 2:	2		
Additional information:	450 V / 10 A		



# POWER CORDS & EXTENSIONS

## KCCAB4055

POWER AND MICROPHONE CABLE SCHUKO POWER & XLR FEMALE TO EURO POWER & XLR MALE 5 M



### SPECIFICATIONS

Product type:	Combination Cable
Cable designation:	KCPAC55
Length:	5 m
Colour:	black
Overall diameter:	17 mm
Jacket material:	PVC
Connector 1-A:	Earthing contact Type E+F (CEE 7/7)
Gender of connector 1-A:	male
Poles of connector 1-A:	3
Connector 1-B:	XLR
Gender of connector 1-B:	female
Poles of connector 1-B:	3
Connector 1-C:	XLR
Gender of connector 1-C:	female
Poles of connector 1-C:	3
Connector 2-A:	Non-heating appliances
Gender of connector 2-A:	female
Poles of connector 2-A:	3
Connector 2-B:	XLR
Gender of connector 2-B:	male
Poles of connector 2-B:	3
Connector 2-C:	XLR
Gender of connector 2-C:	male
Poles of connector 2-C:	3
Inner conductor 1 cross-section:	1.5 mm <sup>2</sup>
Inner conductor 1 material:	copper
Inner conductor 1 construction:	30 x 0.25 mm
Number of inner conductors 1:	3
Inner conductor 2 cross-section:	0.16 mm <sup>2</sup>
Inner conductor 2 material:	copper
Inner conductor 2 construction:	14 x 0.12 mm
Number of inner conductors 2:	4
Additional information:	450 V / 16 A

# POWER CORDS & EXTENSIONS

## KCCAB405##

POWER AND MICROPHONE CABLE EARTHING CONTACT & XLR FEMALE TO EURO  
POWER & XLR MALE



### SPECIFICATIONS

Product type:	Combination Cable
Cable designation:	KCPAC55
Colour:	black
Overall diameter:	17 mm
Jacket material:	PVC
Connector 1-A:	Earthing contact Type E+F (CEE 7/7)
Gender of connector 1-A:	male
Poles of connector 1-A:	3
Connector 1-B:	XLR
Gender of connector 1-B:	female
Poles of connector 1-B:	3
Connector 1-C:	XLR
Gender of connector 1-C:	female
Poles of connector 1-C:	3
Connector 2-A:	Non-heating appliances
Gender of connector 2-A:	female
Poles of connector 2-A:	3
Connector 2-B:	XLR
Gender of connector 2-B:	male
Poles of connector 2-B:	3
Connector 2-C:	XLR
Gender of connector 2-C:	male
Poles of connector 2-C:	3
Inner conductor 1 cross-section:	1.5 mm <sup>2</sup>
Inner conductor 1 material:	copper
Inner conductor 1 construction:	30 x 0.25 mm
Number of inner conductors 1:	3
Inner conductor 2 cross-section:	0.16 mm <sup>2</sup>
Inner conductor 2 material:	copper
Inner conductor 2 construction:	14 x 0.12 mm
Number of inner conductors 2:	4
Additional information:	450 V / 16 A

Article No.	Length
KCCAB40515	15 m
KCCAB40520	20 m

# POWER CORDS & EXTENSIONS

## 8101KP0135GB

POWER CORD BS1363/A (UK) – POWERCON NAC3FCA 1,35 M

### SPECIFICATIONS

Type:	Power cord
Length:	1,35 m
Colour:	black
Cable diameter:	5.8 mm
Cable type:	H05VV-F
Center conductor cross section:	3 x 1.5 mm <sup>2</sup>
Connectors:	BS1363/A, NAC3FCA



## 8101PCONL

POWERCON LINK CABLE

### SPECIFICATIONS

Product type	Power cord
Type	Power Extension Cable
Length:	1,5 m
Colour:	black
Cable type:	H07RN-F
Center conductor cross section:	3 x 1.5 mm <sup>2</sup>
Connectors:	2 x NL4FX



NEW!

Item No.	Length
8101PCONL0300	3 m
8101PCONL0500	5 m
8101PCONL1000	10 m

## 8101TCONL

POWERCON TRUE1 LINK CABLE IP65

### SPECIFICATIONS

Product type	Power cord
Type	Power Extension Cable
Length:	1,5 m
Colour:	black
Cable type:	H07RN-F
Center conductor cross section:	3 x 1.5 mm <sup>2</sup>
Connectors:	1 x NAC3FX-W, 1 x NAC3MX-W



NEW!

Item No.	Length
8101TCONL0300	3 m
8101TCONL0500	5 m
8101TCONL1000	10 m

# POWER CORDS & EXTENSIONS

## KCCAB##

POWER CABLE BLUE POWERCON TO GREY POWERCON

### SPECIFICATIONS

Product type:	Power cord	<b>Article No.</b>	<b>Length</b>
Type:	powerCON	KCCAB440150	1.5 m
Colour:	black	KCCAB440300	3 m
Cable type:	3G2.5 / HO7RN-F	KCCAB440500	5 m
Connector 1:	powerCON		
Connector 2:	powerCON		



## KCCAB442150

POWER CABLE BLUE POWERCON TO EARTHING CONTACT MALE 1.5 M

### SPECIFICATIONS

Product type:	Power cord
Type:	Adapter cable
Length:	1.5 m
Colour:	black
Cable Type:	3G2.5 / HO78RN-F
Cable diameter:	12.5 mm
Center conductor cross section:	2.5 mm <sup>2</sup>
Connector 1:	Earthing contact Type E+F (CEE 7/7)
Gender of connector 1:	male
Poles of connector 1:	3
Connector 2:	powerCON
Gender of connector 2:	female
Poles of connector 2:	3



## KCCAB448150G

POWER CABLE GREY POWERCON TO EARTHING CONTACT FEMALE GERMANY 1.5 M

### SPECIFICATIONS

Product type:	Power cord
Type:	Adapter cable
Length:	1.5 m
Colour:	black
Cable Type:	3G2.5 / HO7RN-F
Center conductor cross section:	2.5 mm <sup>2</sup>
Connector 1:	Earthing contact Type F (CEE 7/4)
Gender of connector 1:	female
Poles of connector 1:	3
Connector 2:	powerCON
Gender of connector 2:	grey / power-out
Poles of connector 2:	3
Other features:	German earthing contact coupling









# PROCAB

PREMIUM  
**QUALITY CABLES**

With gold plated plugs and contacts for corrosion resistance and maximum signal transfer, the Procab line includes adapter and specialty cables that are designed for professional performance.

# PROCAB CABLES

## KCREF61##

AUDIO CABLE 3.5 MM JACK STEREO TO 3.5 MM JACK STEREO

### SPECIFICATIONS

Product type:	Twin Cable
Type:	Audio cable
Colour:	black
Cable diameter:	2 x 4 mm
Center conductor cross section:	0.16 mm <sup>2</sup>
Conductor material:	Copper tin-plated
Conductor construction:	14 x 0.12 mm
Shield material:	Copper tin-plated
Shield:	Spiral shielding
Jacket material:	PVC
Connector 1-A:	3.5 mm jack
Gender of connector 1-A:	male
Poles of connector 1-A:	3
Contacts of connector 1-A:	gold plated
Manufacturer of connector 1-A:	Procab
Connector 2-A:	3.5 mm jack
Gender of connector 2-A:	male
Poles of connector 2-A:	3
Contacts of connector 2-A:	gold plated
Manufacturer of connector 2-A:	Procab

Article No.	Length
KCREF612150	1.5 m
KCREF6123	3 m
KCREF6125	5 m



## KCREF63##

AUDIO CABLE 2 X 6.3 MM JACK MONO TO 2 X RCA MALE

### SPECIFICATIONS

Product type:	Twin Cable
Type:	Audio cable
Colour:	black
Cable diameter:	2 x 4 mm
Center conductor cross section:	0.16 mm <sup>2</sup>
Conductor material:	Copper tin-plated
Conductor construction:	14 x 0.12 mm
Shield material:	Copper tin-plated
Shield:	Spiral shielding
Jacket material:	PVC

Article No.	Length
KCREF631150	1.5 m
KCREF6313	3 m
KCREF6315	5 m



# PROCAB CABLES

## KCREF701##

AUDIO CABLE 2 X XLR MALE TO 2 X RCA MALE

### SPECIFICATIONS

Product type:	Twin Cable
Type:	Audio cable
Colour:	black
Cable diameter:	2 x 4 mm
Center conductor cross section:	0.16 mm <sup>2</sup>
Conductor material:	Copper tin-plated
Conductor construction:	14 x 0.12 mm
Shield material:	Copper tin-plated / aluminium foil
Shield:	Braided / spiral shielding
Jacket material:	PVC
Connector 1-A:	XLR
Gender of connector 1-A:	male
Poles of connector 1-A:	3
Contacts of connector 1-A:	gold plated
Manufacturer of connector 1-A:	Procab
Connector 1-B:	XLR

Gender of connector 1-B:	male
Poles of connector 1-B:	3
Contacts of connector 1-B:	gold plated
Manufacturer of connector 1-B:	Procab
Connector 2-A:	RCA
Gender of connector 2-A:	male
Poles of connector 2-A:	2
Contacts of connector 2-A:	gold plated
Manufacturer of connector 2-A:	Procab
Connector 2-B:	RCA
Gender of connector 2-B:	male
Poles of connector 2-B:	2
Contacts of connector 2-B:	gold plated
Manufacturer of connector 2-B:	Procab

Article No.	Lenght
KCREF701150	1.5 m
KCREF7013	3 m



## KCREF703##

AUDIO CABLE XLR MALE TO 2 X RCA MALE

### SPECIFICATIONS

Product type:	Twin Cable
Type:	Audio cable
Colour:	black
Cable diameter:	2 x 4 mm
Center conductor cross section:	0.16 mm <sup>2</sup>
Conductor material:	Copper tin-plated
Conductor construction:	14 x 0.12 mm
Shield material:	Copper tin-plated / aluminium foil
Shield:	Braided / spiral shielding
Jacket material:	PVC
Connector 1-A:	XLR
Gender of connector 1-A:	male
Poles of connector 1-A:	3
Contacts of connector 1-A:	gold plated

Manufacturer of connector 1-A:	Procab
Connector 2-A:	RCA
Gender of connector 2-A:	male
Poles of connector 2-A:	2
Contacts of connector 2-A:	gold plated
Manufacturer of connector 2-A:	Procab
Connector 2-B:	RCA
Gender of connector 2-B:	male
Poles of connector 2-B:	2
Contacts of connector 2-B:	gold plated
Manufacturer of connector 2-B:	Procab

Article No.	Lenght
KCREF703150	1.5 m
KCREF7033	3 m



# PROCAB CABLES

## KCREF704150

AUDIO CABLE XLR FEMALE TO 2 X RCA MALE

### SPECIFICATIONS

Product type	Twin Cable
Type	Audio cable
Length	1.5 m
Colour	black
Cable diameter	2 x 4 mm
Center conductor cross section	0.16 mm <sup>2</sup>
Conductor material	Copper tin-plated
Conductor construction	14 x 0.12 mm
Shield material	Copper tin-plated / aluminium foil
Shield	Braided / spiral shielding
Jacket material	PVC
Connector 1-A	XLR
Gender of connector 1-A	female
Poles of connector 1-A	3
Contacts of connector 1-A	gold plated
Manufacturer of connector 1-A	Procab

Connector 2-A	RCA
Gender of connector 2-A	male
Poles of connector 2-A	2
Contacts of connector 2-A	gold plated
Manufacturer of connector 2-A	Procab
Connector 2-B	RCA
Gender of connector 2-B	male
Poles of connector 2-B	2
Contacts of connector 2-B	gold plated
Manufacturer of connector 2-B	Procab



## KCREF705##

AUDIO CABLE 2 X XLR FEMALE TO 2 X RCA MALE

### SPECIFICATIONS

Product type:	Twin Cable
Type:	Audio cable
Colour:	black
Cable diameter:	2 x 4 mm
Center conductor cross section:	0.16 mm <sup>2</sup>
Conductor material:	Copper tin-plated
Conductor construction:	14 x 0.12 mm
Shield material:	Copper tin-plated / aluminium foil
Shield:	Braided / spiral shielding
Jacket material:	PVC
Connector 1-A:	XLR
Gender of connector 1-A:	female
Poles of connector 1-A:	3
Contacts of connector 1-A:	gold plated
Manufacturer of connector 1-A:	Procab
Connector 1-B:	XLR

Gender of connector 1-B:	female
Poles of connector 1-B:	3
Contacts of connector 1-B:	gold plated
Manufacturer of connector 1-B:	Procab
Connector 2-A:	RCA
Gender of connector 2-A:	male
Poles of connector 2-A:	2
Contacts of connector 2-A:	gold plated
Manufacturer of connector 2-A:	Procab
Connector 2-B:	RCA
Gender of connector 2-B:	male
Poles of connector 2-B:	2
Contacts of connector 2-B:	gold plated
Manufacturer of connector 2-B:	Procab

Article No.	Length
KCREF705150	1.5 m
KCREF7053	3 m



# PROCAB CABLES

## KCREF707##

AUDIO CABLE 2 X XLR FEMALE TO 2 X 6.3 MM JACK MONO

### SPECIFICATIONS

Product type:	Twin Cable
Type:	Audio cable
Colour:	black
Cable diameter:	2 x 4 mm
Center conductor cross section:	0.16 mm <sup>2</sup>
Conductor material:	Copper tin-plated
Conductor construction:	14 x 0.12 mm
Shield material:	Copper tin-plated / aluminium foil
Shield:	Braided / spiral shielding
Jacket material:	PVC
Connector 1-A:	XLR
Gender of connector 1-A:	female
Poles of connector 1-A:	3
Contacts of connector 1-A:	gold plated
Manufacturer of connector 1-A:	Procab
Connector 1-B:	XLR

Gender of connector 1-B:	female
Poles of connector 1-B:	3
Contacts of connector 1-B:	gold plated
Manufacturer of connector 1-B:	Procab
Connector 2-A:	6.3 mm Jack
Gender of connector 2-A:	male
Poles of connector 2-A:	2
Contacts of connector 2-A:	gold plated
Manufacturer of connector 2-A:	Procab
Connector 2-B:	6.3 mm Jack
Gender of connector 2-B:	male
Poles of connector 2-B:	2
Contacts of connector 2-B:	gold plated
Manufacturer of connector 2-B:	Procab

Article No.	Length
KCREF707150	1.5 m
KCREF7073	3 m



## KCREF708##

AUDIO CABLE 2 X XLR MALE TO 2 X 6.3 MM JACK MONO

### SPECIFICATIONS

Product type:	Twin Cable
Type:	Audio cable
Colour:	black
Cable diameter:	2 x 4 mm
Center conductor cross section:	0.16 mm <sup>2</sup>
Conductor material:	Copper tin-plated
Conductor construction:	14 x 0.12 mm
Shield material:	Copper tin-plated
Shield:	Spiral shielding
Jacket material:	PVC
Connector 1-A:	XLR
Gender of connector 1-A:	male
Poles of connector 1-A:	3
Contacts of connector 1-A:	gold plated
Manufacturer of connector 1-A:	Procab
Connector 1-B:	XLR
Gender of connector 1-B:	male
Poles of connector 1-B:	3

Contacts of connector 1-B:	gold plated
Manufacturer of connector 1-B:	Procab
Connector 2-A:	6.3 mm Jack
Gender of connector 2-A:	male
Poles of connector 2-A:	2
Contacts of connector 2-A:	gold plated
Manufacturer of connector 2-A:	Procab
Connector 2-B:	6.3 mm Jack
Gender of connector 2-B:	male
Poles of connector 2-B:	2
Contacts of connector 2-B:	gold plated
Manufacturer of connector 2-B:	Procab

Article No.	Length
KCREF708150	1.5 m
KCREF7083	3 m



# PROCAB CABLES

## KCREF709##

AUDIO CABLE 6.3 MM JACK STEREO TO 1 X XLR MALE AND 1 X XLR FEMALE

### SPECIFICATIONS

Product type:	Twin Cable
Type:	Audio cable
Colour:	black
Cable diameter:	2 x 4 mm
Center conductor cross section:	0.16 mm <sup>2</sup>
Conductor material:	Copper tin-plated
Conductor construction:	14 x 0.12 mm
Shield material:	Copper tin-plated / aluminium foil
Shield:	Braided / spiral shielding
Jacket material:	PVC
Connector 1-A:	6.3 mm Jack
Gender of connector 1-A:	male
Poles of connector 1-A:	3
Contacts of connector 1-A:	gold plated

Manufacturer of connector 1-A:	Procab
Connector 2-A:	XLR
Gender of connector 2-A:	male
Poles of connector 2-A:	3
Contacts of connector 2-A:	gold plated
Manufacturer of connector 2-A:	Procab
Connector 2-B:	XLR
Gender of connector 2-B:	female
Poles of connector 2-B:	3
Contacts of connector 2-B:	gold plated
Manufacturer of connector 2-B:	Procab

Article No.	Lenght
KCREF7093	3 m
KCREF7095	5 m



## KCREF710##

AUDIO CABLE 2 X XLR FEMALE TO 2 X XLR MALE

### SPECIFICATIONS

Product type:	Twin Cable
Type:	Audio cable
Colour:	black
Cable diameter:	2 x 6 mm
Center conductor cross section:	0.16 mm <sup>2</sup>
Conductor material:	Copper tin-plated
Conductor construction:	14 x 0.12 mm
Shield material:	Copper tin-plated
Shield:	Braided shielding
Jacket material:	PVC
Connector 1-A:	XLR
Gender of connector 1-A:	male
Poles of connector 1-A:	3
Contacts of connector 1-A:	gold plated
Manufacturer of connector 1-A:	Procab
Connector 1-B:	XLR
Gender of connector 1-B:	male
Poles of connector 1-B:	3
Contacts of connector 1-B:	gold plated
Manufacturer of connector 1-B:	Procab

Connector 2-A:	XLR
Gender of connector 2-A:	female
Poles of connector 2-A:	3
Contacts of connector 2-A:	gold plated
Manufacturer of connector 2-A:	Procab
Connector 2-B:	XLR
Gender of connector 2-B:	female
Poles of connector 2-B:	3
Contacts of connector 2-B:	gold plated
Manufacturer of connector 2-B:	Procab

Article No.	Lenght
KCREF710050	0.5 m
KCREF710150	1.5 m
KCREF7103	3 m



# PROCAB CABLES

## KCREF711##

AUDIO CABLE 3.5 MM JACK STEREO TO 2 X RCA MALE

### SPECIFICATIONS

Product type:	Twin Cable
Type:	Audio cable
Colour:	black
Cable diameter:	2 x 4 mm
Center conductor cross section:	0.16 mm <sup>2</sup>
Conductor material:	Copper tin-plated
Conductor construction:	14 x 0.12 mm
Shield material:	Copper tin-plated / aluminium foil
Shield:	Braided / spiral shielding
Jacket material:	PVC
Connector 1-A:	3.5 mm jack
Gender of connector 1-A:	male
Poles of connector 1-A:	3
Contacts of connector 1-A:	gold plated

Manufacturer of connector 1-A:	Procab
Connector 2-A:	RCA
Gender of connector 2-A:	male
Poles of connector 2-A:	2
Contacts of connector 2-A:	gold plated
Manufacturer of connector 2-A:	Procab
Connector 2-B:	RCA
Gender of connector 2-B:	male
Poles of connector 2-B:	2
Contacts of connector 2-B:	gold plated
Manufacturer of connector 2-B:	Procab

Article No.	Length
KCREF711150	1.5 m
KCREF71113	3 m
KCREF71115	5 m
KCREF71110	10 m



## KCREF713##

AUDIO CABLE 3.5 MM JACK STEREO TO 2 X 6.3 MM JACK MONO

### SPECIFICATIONS

Product type:	Twin Cable
Type:	Audio cable
Colour:	black
Cable diameter:	2 x 4 mm
Center conductor cross section:	0.16 mm <sup>2</sup>
Conductor material:	Copper tin-plated
Conductor construction:	14 x 0.12 mm
Shield material:	Copper tin-plated / aluminium foil
Shield:	Braided / spiral shielding
Jacket material:	PVC
Connector 1-A:	3.5 mm jack
Gender of connector 1-A:	male
Poles of connector 1-A:	3
Contacts of connector 1-A:	gold plated

Manufacturer of connector 1-A:	Procab
Connector 2-A:	6.3 mm Jack
Gender of connector 2-A:	male
Poles of connector 2-A:	2
Contacts of connector 2-A:	gold plated
Manufacturer of connector 2-A:	Procab
Connector 2-B:	6.3 mm Jack
Gender of connector 2-B:	male
Poles of connector 2-B:	2
Contacts of connector 2-B:	gold plated
Manufacturer of connector 2-B:	Procab

Article No.	Length
KCREF713150	1.5 m
KCREF7133	3 m





# PROCAB CABLES

## KCREF719##

AUDIO CABLE 6.3 MM JACK STEREO TO 2 X RCA MALE

### SPECIFICATIONS

Product type:	Twin Cable
Type:	Audio cable
Length:	1.5 m
Colour:	black
Cable diameter:	2 x 4 mm
Center conductor cross section:	0.16 mm <sup>2</sup>
Conductor material:	Copper tin-plated
Conductor construction:	14 x 0.12 mm
Shield material:	Copper tin-plated
Shield:	Spiral shielding
Jacket material:	PVC
Connector 1-A:	6.3 mm Jack
Gender of connector 1-A:	male
Poles of connector 1-A:	3
Contacts of connector 1-A:	gold plated
Manufacturer of connector 1-A:	Procab

Connector 2-A:	RCA
Gender of connector 2-A:	male
Poles of connector 2-A:	2
Contacts of connector 2-A:	gold plated
Manufacturer of connector 2-A:	Procab
Connector 2-B:	RCA
Gender of connector 2-B:	male
Poles of connector 2-B:	2
Contacts of connector 2-B:	gold plated
Manufacturer of connector 2-B:	Procab

Article No.	Length
KCREF719150	1.5 m
KCREF7193	3 m



## KCREF721#

AUDIO CABLE 6.3 MM JACK STEREO TO 2 X 6.3 JACK MONO

### SPECIFICATIONS

Product type:	Twin Cable
Type:	Audio cable
Colour:	black
Cable diameter:	2 x 4 mm
Center conductor cross section:	0.16 mm <sup>2</sup>
Conductor material:	Copper tin-plated
Conductor construction:	14 x 0.12 mm
Shield material:	Copper tin-plated / aluminium foil
Shield:	Braided / spiral shielding
Jacket material:	PVC
Connector 1-A:	6.3 mm Jack
Gender of connector 1-A:	male
Poles of connector 1-A:	3
Contacts of connector 1-A:	gold plated
Manufacturer of connector 1-A:	Procab
Connector 2-A:	6.3 mm Jack

Gender of connector 2-A:	male
Poles of connector 2-A:	2
Contacts of connector 2-A:	gold plated
Manufacturer of connector 2-A:	Procab
Connector 2-B:	6.3 mm Jack
Gender of connector 2-B:	male
Poles of connector 2-B:	2
Contacts of connector 2-B:	gold plated
Manufacturer of connector 2-B:	Procab

Article No.	Length
KCREF721150	1.5 m
KCREF7213	3 m



# PROCAB CABLES

## KCCIP7082

AUDIO CABLE 3.5 MM JACK STEREO MALE TO 3.5 MM JACK STEREO MALE 2 M



### SPECIFICATIONS

Product :	Multimedia Cable
Type:	Audio cable
Length:	2 m
Colour:	white
Connector 1-A:	3.5 mm jack
Number of connectors connector 1-A:	1
Gender of connector 1-A:	male
Poles of connector 1-A:	3
Connector 2-A:	3.5 mm jack
Number of connectors connector 2-A:	1
Gender of connector 2-A:	male
Poles of connector 2-A:	3

## KCREF71##

AUDIO CABLE 2 X XLR FEMALE TO 2 X 6.3 MM JACK MONO

### SPECIFICATIONS

Product type:	Twin Cable	Gender of connector 2-A:	male
Type:	Audio cable	Poles of connector 2-A:	3
Colour:	black	Contacts of connector 2-A:	gold plated
Cable diameter:	2 x 4 mm	Manufacturer of connector 2-A:	Procab
Center conductor cross section:	0.16 mm <sup>2</sup>	Connector 2-B:	XLR
Conductor material:	Copper tin-plated	Gender of connector 2-B:	male
Conductor construction:	14 x 0.12 mm	Poles of connector 2-B:	3
Shield material:	Copper tin-plated / aluminium foil	Contacts of connector 2-B:	gold plated
Shield:	Braided / spiral shielding	Manufacturer of connector 2-B:	Procab
Jacket material:	PVC		
Connector 1-A:	3.5 mm jack	<b>Article No.</b>	<b>Lenght</b>
Gender of connector 1-A:	male	KCREF712150	1.5 m
Poles of connector 1-A:	3	KCREF7123	3 m
Contacts of connector 1-A:	gold plated		
Manufacturer of connector 1-A:	Procab		
Connector 2-A:	XLR		



# PROCAB CABLES

## KCREF723150

MICROPHONE CABLE XLR FEMALE TO  
6.3 MM JACK STEREO

### SPECIFICATIONS

Product type:	Microphone cable
Length:	1.5 m
Colour:	black
Cable diameter:	6 mm
Center conductor cross section:	0.23 mm <sup>2</sup>
Connector 1:	XLR
Gender of connector 1:	female
Poles of connector 1:	3
Contacts of connector 1:	gold plated
Manufacturer of connector 1:	Procab
Model number connector 1:	custom made
Connector 2:	6.3 mm Jack
Gender of connector 2:	male
Poles of connector 2:	3
Contacts of connector 2:	gold plated
Manufacturer of connector 2:	Procab
Model number connector 2:	custom made



## KCREF714150

AUDIO CABLE 1 X 3.5 MM JACK STEREO TO XLR  
MALE

### SPECIFICATIONS

Product type:	Twin Cable
Type:	Audio cable
Length:	1.5 m
Colour:	black
Cable diameter:	2 x 4 mm
Center conductor cross section:	0.16 mm <sup>2</sup>
Conductor material:	Copper tin-plated
Conductor construction:	14 x 0.12 mm
Shield material:	Copper tin-plated / aluminium foil
Shield:	Braided / spiral shielding
Jacket material:	PVC
Connector 1-A:	3.5 mm jack
Gender of connector 1-A:	male
Poles of connector 1-A:	3
Contacts of connector 1-A:	gold plated
Manufacturer of connector 1-A:	Procab
Connector 2-A:	XLR
Gender of connector 2-A:	male
Poles of connector 2-A:	3
Contacts of connector 2-A:	gold plated
Manufacturer of connector 2-A:	Procab



# PROCAB CABLES

## KCREF735150

AUDIO CABLE XLR FEMALE TO 2 X XLR MALE

### SPECIFICATIONS

Product type:	Twin Cable
Type:	Audio cable
Length:	1.5 m
Colour:	black
Cable diameter:	2 x 6 mm
Center conductor cross section:	0.16 mm <sup>2</sup>
Conductor material:	Copper tin-plated
Conductor construction:	14 x 0.12 mm
Shield material:	Copper tin-plated
Shield:	Braided shielding
Jacket material:	PVC
Connector 1-A:	XLR
Gender of connector 1-A:	female
Poles of connector 1-A:	3

Contacts of connector 1-A:	gold plated
Manufacturer of connector 1-A:	Procab
Connector 2-A:	XLR
Gender of connector 2-A:	male
Poles of connector 2-A:	3
Contacts of connector 2-A:	gold plated
Manufacturer of connector 2-A:	Procab
Connector 2-B:	XLR
Gender of connector 2-B:	male
Poles of connector 2-B:	3
Contacts of connector 2-B:	gold plated
Manufacturer of connector 2-B:	Procab



## KCREF736150

AUDIO CABLE XLR MALE TO 2 X XLR FEMALE

### SPECIFICATIONS

Product type:	Twin Cable
Type:	Audio cable
Length:	1.5 m
Colour:	black
Cable diameter:	2 x 6 mm
Center conductor cross section:	0.16 mm <sup>2</sup>
Conductor material:	Copper tin-plated
Conductor construction:	14 x 0.12 mm
Shield material:	Copper tin-plated
Shield:	Braided shielding
Jacket material:	PVC
Connector 1-A:	XLR
Gender of connector 1-A:	male
Poles of connector 1-A:	3

Contacts of connector 1-A:	gold plated
Manufacturer of connector 1-A:	Procab
Connector 2-A:	XLR
Gender of connector 2-A:	female
Poles of connector 2-A:	3
Contacts of connector 2-A:	gold plated
Manufacturer of connector 2-A:	Procab
Connector 2-B:	XLR
Gender of connector 2-B:	female
Poles of connector 2-B:	3
Contacts of connector 2-B:	gold plated
Manufacturer of connector 2-B:	Procab



# PROCAB CABLES

## KCREF80##

AUDIO CABLE 2 X RCA MALE TO 2 X RCA MALE

### SPECIFICATIONS

Product type:	Twin Cable
Type:	Audio cable
Colour:	black
Cable diameter:	2 x 4 mm
Center conductor cross section:	0.16 mm <sup>2</sup>
Conductor material:	Copper tin-plated
Conductor construction:	14 x 0.12 mm
Shield material:	Copper tin-plated
Shield:	Spiral shielding
Jacket material:	PVC
Connector 1-A:	RCA
Gender of connector 1-A:	male
Poles of connector 1-A:	2
Contacts of connector 1-A:	gold plated
Manufacturer of connector 1-A:	Procab
Connector 1-B:	RCA
Gender of connector 1-B:	male
Poles of connector 1-B:	2

Contacts of connector 1-B:	gold plated
Manufacturer of connector 1-B:	Procab
Connector 2-A:	RCA
Gender of connector 2-A:	male
Poles of connector 2-A:	2
Contacts of connector 2-A:	gold plated
Manufacturer of connector 2-A:	Procab
Connector 2-B:	RCA
Gender of connector 2-B:	male
Poles of connector 2-B:	2
Contacts of connector 2-B:	gold plated
Manufacturer of connector 2-B:	Procab

Article No.	Length
KCREF800050	0.5 m
KCREF8001	1 m
KCREF800150	1.5 m
KCREF8003	3 m
KCREF8005	5 m



## KCBSP602B

PIGTAIL ADAPTER HDMI 19 FEMALE TO HDMI 19 FEMALE WITH FIXING SCREWS BLACK

### SPECIFICATIONS

Product type:	Video Adapter
Type:	Adapter Cable
Connector 1:	HDMI 19
Gender of connector 1:	female
Connector 2:	HDMI 19
Gender of connector 2:	female
Housing:	plastic
Additional information:	black, with fixing screws



# PROCAB CABLES

## KCREF790090

PATCH CABLE SET 6.3 MM JACK STEREO TO 6.3 MM ANGLED JACK STEREO

### SPECIFICATIONS

Product type:	Patch Cable Set
Length:	0.9 m
Colour:	6-colour
Cable diameter:	4.7 mm
Center conductor cross section:	0.16 mm <sup>2</sup>
Connector 1:	Angled jack 6.3 mm
Gender of connector 1:	male
Poles of connector 1:	3
Contacts of connector 1:	gold plated
Manufacturer of connector 1:	Procab
Model number connector 1:	custom made
Connector 2:	6.3 mm Jack
Gender of connector 2:	male
Poles of connector 2:	3
Contacts of connector 2:	gold plated
Manufacturer of connector 2:	Procab
Model number connector 2:	custom made
Other features:	Set consisting of 6 cables

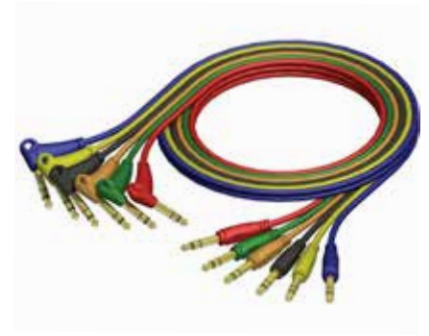

## KCREF792090

PATCH CABLE SET 6.3 MM JACK STEREO TO 6.3 MM JACK STEREO

### SPECIFICATIONS

Product type:	Patch Cable Set
Length:	0.9 m
Colour:	6-colour
Cable diameter:	4.7 mm
Center conductor cross section:	0.16 mm <sup>2</sup>
Connector 1:	6.3 mm Jack
Gender of connector 1:	male
Poles of connector 1:	3
Contacts of connector 1:	gold plated
Manufacturer of connector 1:	Procab
Model number connector 1:	custom made
Connector 2:	6.3 mm Jack
Gender of connector 2:	male
Poles of connector 2:	3
Contacts of connector 2:	gold plated
Manufacturer of connector 2:	Procab
Model number connector 2:	custom made
Other features:	Set consisting of 6 cables



# PROCAB CABLES

## KCCAV##

VIDEO CABLE SVGA MALE TO SVGA MALE

### SPECIFICATIONS

Product type:	Multimedia Cable
Type:	Video Cables
Colour:	black
Connector 1-A:	SVGA
Number of connectors connector 1-A:	1
Gender of connector 1-A:	male
Connector 2-A:	SVGA
Number of connectors connector 2-A:	1
Gender of connector 2-A:	male

Article No.	Lenght
KCCAV1143	3 m
KCCAV11415	15 m
KCCAV11420	20 m
KCCAV11425	25 m
KCCAV11430	30 m



## KCREF61##

INSTRUMENT CABLE 6.3 MM JACK STEREO TO 6.3 MM JACK STEREO

### SPECIFICATIONS

Product type:	instrument cables
Colour:	black
Cable diameter:	5.9 mm
Center conductor cross section:	0.22 mm <sup>2</sup>
Connector 1:	6.3 mm Jack
Gender of connector 1:	male
Contacts of connector 1:	gold plated
Manufacturer of connector 1:	Procab
Model number connector 1:	custom made
Connector 2:	6.3 mm Jack
Gender of connector 2:	male
Contacts of connector 2:	gold plated
Manufacturer of connector 2:	Procab
Model number connector 2:	custom made

Article No.	Lenght
KCREF610150	1.5 m
KCREF6103	3 m
KCREF6105	5 m
KCREF61010	10 m





# PROCAB CABLES

## KCREF60##

INSTRUMENT CABLE 6.3 MM JACK MONO TO 6.3 MM JACK MONO

### SPECIFICATIONS

Product type:	instrument cables
Colour:	black
Cable diameter:	5.9 mm
Center conductor cross section:	0.22 mm <sup>2</sup>
Connector 1:	6.3 mm Jack
Gender of connector 1:	male

Contacts of connector 1:	gold plated
Manufacturer of connector 1:	Procab
Model number connector 1:	custom made
Connector 2:	6.3 mm Jack
Gender of connector 2:	male
Contacts of connector 2:	gold plated
Manufacturer of connector 2:	Procab
Model number connector 2:	custom made

Article No.	Length
KCREF600150	1.5 m
KCREF6003	3 m



## KCREF724##

MICROPHONE CABLE XLR MALE TO 6.3 MM JACK STEREO

### SPECIFICATIONS

Product type:	Microphone cable
Colour:	black
Cable diameter:	5.9 mm
Center conductor cross section:	0.22 mm <sup>2</sup>
Connector 1:	XLR
Gender of connector 1:	male

Poles of connector 1:	3
Contacts of connector 1:	gold plated
Manufacturer of connector 1:	Procab
Model number connector 1:	custom made
Connector 2:	6.3 mm Jack
Gender of connector 2:	male
Poles of connector 2:	3
Contacts of connector 2:	gold plated
Manufacturer of connector 2:	Procab
Model number connector 2:	custom made

Article No.	Length
KCREF724150	1.5 m
KCREF7243	3 m
KCREF7245	5 m







## **SPEAKER STANDS**

For easy speaker positioning we stock pneumatic stands, telescoping subwoofer poles and wall mounts. Our lightweight economy stands are also available in sets of two with cables and carry bag.

# SPEAKER STANDS



## SPS023

### SPEAKER STAND BLACK

- Aluminium
- Can be fixed secure in 5 steps (each step 17 cm) with included safety bolt
- Unbeatable price/performance ratio!

#### SPECIFICATIONS

Product type	Speaker stand
Tubing material	aluminium
Tubing colour	black
Tubing surface	powder coated
Min. height	1250 mm
Max. height	1950 mm
Transport length	1040 mm
Joint material	plastic
Tubing diameter	41/35 mm
Max. load	25 kg



## SPS023S

### SPEAKER STAND SILVER

- Aluminium
- Can be fixed secure in 5 steps (each step 17 cm) with included safety bolt
- Unbeatable value for money!

#### SPECIFICATIONS

Product type	Speaker stand
Tubing material	aluminium
Tubing colour	silver
Tubing surface	anodized
Min. height	1250 mm
Max. height	1950 mm
Transport length	1040 mm
Joint material	plastic
Tubing diameter	41/35 mm
Max. load	25 kg



## SPS54B

### SPEAKER STAND BLACK

- Steel speaker stand
- Very stable due to double bracing
- All joints constructed of metal
- With "safety-pin" security lock

#### SPECIFICATIONS

Product type	Speaker stand
Tubing material	steel
Tubing colour	black
Tubing surface	powder coated
Min. height	1100 mm
Max. height	2000 mm
Joint material	metal
Tubing diameter	35 mm
Max. load	35 kg

# SPEAKER STANDS



## SPS56B

### SPEAKER STAND BLACK

- Black aluminium speaker stand with pneumatic suspension
- The air cushioning guarantees a secure descent and easier handling of the speaker.

#### SPECIFICATIONS

Product type	Speaker stand
Tubing material	aluminium
Tubing colour	black
Tubing surface	powder coated
Min. height	1200 mm
Max. height	2000 mm
Joint material	metal
Tubing diameter	40/35 mm
Max. load	30 kg
Additional information	with pneumatic suspension



## SPS56S

### SPEAKER STAND SILVER

- Silver aluminium speaker stand with pneumatic suspension
- The air cushioning guarantees a secure descent and easier handling of the speaker.

#### SPECIFICATIONS

Product type	Speaker stand
Tubing material	aluminium
Tubing colour	silver
Tubing surface	anodized
Min. height	2000 mm
Max. height	2000 mm
Joint material	metal
Tubing diameter	40/35 mm
Max. load	30 kg
Additional information	with pneumatic suspension



## SPS821

### SPEAKER POLE 35MM

Extendable speaker pole, steel black, with 35mm lower connector.

#### SPECIFICATIONS

Product type	Speaker pole
Material	steel
Surface	powder coated
Colour	black
Min. length	840 mm
Max. length	1120 mm
Fitting	plug-in (ø 35 mm)



## SPS822

### SPEAKER POLE M20 THREAD

Extendable speaker pole, steel black, with M20 threaded lower fitting.

#### SPECIFICATIONS

Product type	Speaker pole
Material	steel
Surface	powder coated
Colour	black
Min. length	840 mm
Max. length	1120 mm
Fitting	threaded (M20)

# SPEAKER STANDS



## SPS023SET

SET OF 2 SPEAKER STANDS WITH BAG

Set composed of 2 x black aluminium speaker stands (SPS023) and one transport bag.

### SPECIFICATIONS

Product type	Speaker stand
Tubing material	aluminium
Tubing colour	black
Tubing surface	powder coated
Min. height	1250 mm
Max. height	1950 mm
Transport length	1040 mm
Joint material	plastic
Tubing diameter	41/35 mm
Max. load	25 kg

Model Name	SPS023BAG
Type	Universal transport bag for 2 speaker stands
Material	polyester
Colour	black
Depth / Width / Height	220 mm x 1140 mm x 150 mm
Weight	0.8 kg
Features	water-repellent, with zipper



## SPS023SET2

SET OF 2 SPEAKER STANDS WITH BAG AND STANDARD SPEAKER CABLES

- Cable length 5 m



## SPS023SET3

SET OF 2 SPEAKER STANDS WITH BAG AND 2 XLR CABLES

- Cable length 10 m



NEW!

## SPS023SET4

SET OF 2 SPEAKER STANDS WITH BAG AND 2 SPEAKER CABLES 6.3 MM JACK

- Cable length 5 m



## SPS023BAG

UNIVERSAL TRANSPORT BAG FOR 2 SPEAKER STANDS

### SPECIFICATIONS

Model Name	SPS023BAG
Material	polyester
Colour	black
Depth / Width / Height	220 mm x 1140 mm x 150 mm
Weight	0.8 kg
Features	water-repellent, with zipper

# SPEAKER STANDS



## SPS57

### EXTERNAL POLE MOUNT BRACKET

- Speaker cabinet mounting flange
- Black plastic
- For speaker cabinets without built-in pole mounts
- Requires no space inside the speaker cabinet
- Fits on all stands with a pole diameter of 35 mm

### SPECIFICATIONS

Product type	Cabinet Flange
Type	Mounting bracket
Material	plastic
Surface / Color	black
Suitable for tube diameter	35 mm
Flange size	197 x 109 mm
Tilttable	no
With screw clamp	yes
Diameter of fixing holes	6.5 mm
Width / Height / Depth	195 mm / 80 mm / 110 mm



## SMBS5 / W

### WALL MOUNT FOR SPEAKERS, BLACK / WHITE

- Wall mount speaker bracket with mounting pole
- Adjustable tilt

### SPECIFICATIONS

Product type	Speaker Wall Mount
Material	steel
Surface	powder coated
Colour	black /white
Max. load	30 kg
Additional information	for speakers with standard 36mm cabinet flange



## SUWMB10B / W

### UNIVERSAL WALL MOUNT FOR SPEAKERS UP TO 10KG BLACK / WHITE

The SUWMB10 is fully adjustable on all axes and can be individually aligned. It is compatible with all speakers with an appropriate hole pattern or is suitable for direct installation in wood or plastic housing

### SPECIFICATIONS

Product type	Speaker Wall Mount
Material	die-cast aluminium
Surface	powder coated
Colour	black /white
Max. load	10 kg
Additional information	including safety wire (length 20cm), adjustable on all axes



# SPEAKER STANDS



## SPS823

### MOUNTING FORK FOR SPEAKER STANDS

Loudspeaker mounting fork. Steel tube combination for 2 speakers. Fits into all 36 mm diameter top hats. The width is adjustable from 310 - 490 mm.

#### SPECIFICATIONS

Product type	Mounting Fork for Speaker Stands
Colour	black
Material	steel
Surface	powder coated
Suitable for tube diameter	36 mm
Adjustable width	310 mm
Fitting	Screw clamp
Max. load	2 x 25 kg



## SPSG3B

### WALL MOUNT FOR SPEAKERS - PAIR

Speaker bracket for mounting small units to walls or ceilings. Ideally suited for surround speakers in home theatre applications. The universal ball joint allows speakers to be swivelled to any angle.

#### SPECIFICATIONS

Product type	Speaker Wall Mount
Material	steel
Surface	powder coated
Colour	black
Max. load	8 kg
Additional information	with universal joint



## STRA36

### TRUSS ADAPTER FOR 35 MM FOR 35MM TUBES

Truss adapter for 35 mm tripod mounts (e.g. for speaker stands) with variable width (20-40 cm). Indentations for common truss systems facilitate set-up and ensure a central position. Locking pins and cotter pins are included.

#### SPECIFICATIONS

Product type	Truss adapter
Colour	silver
Surface	galvanized
Suitable for tube diameter	35 mm
Adjustable Range	200 - 400 mm
Length	510 mm



## STRA36V

### VERTICAL TRUSS ADAPTER 35 MM FOR 2 POINT TRUSS

This vertical adapter allows you to mount ladder trusses on standard speaker stands. It fits onto 35 mm poles with a large set screw providing secure attachment. The upper yoke features a self-latching mechanism that automatically locks the truss in place when it is inserted, the lower support is adjustable to accept 25 and 29 cm trusses.

#### SPECIFICATIONS

Product type	Truss adapter
Colour	silver
Surface	galvanized
Suitable for tube diameter	35 mm
Length	480 mm
Additional information	djustable for 25 or 29 cm trusses

# SPEAKER STANDS



## SPS36M6

REDUCER FLANGE 36MM TO M6  
THREAD

### SPECIFICATIONS

Product type	Reducer Flange
Colour	black
Material	steel
Surface	painted
Threaded connector	M6 x 12 mm
Suitable for tube diameter	35 mm
Type of adjustment	Screw clamp
Length	100 mm



## SPS36M10

ADAPTER FLANGE 36MM TO M10  
THREAD

### SPECIFICATIONS

Product type	Reducer Flange
Colour	black
Material	steel
Surface	painted
Threaded connector	M10 x 18 mm
Type of adjustment	Screw clamp
Length	100 mm



## SPS36M10I

ADAPTER FLANGE 36MM TO M10  
INNER THREAD

### SPECIFICATIONS

Product type	Reducer Flange
Colour	black
Material	steel
Surface	painted
Threaded connector	M10
Suitable for tube diameter	35 mm
Type of adjustment	Screw clamp
Length	100 mm
Accessories (included)	Bolt M10 x 25 / washer



## SPS36M38

REDUCER FLANGE 36MM TO 3/8" THREAD

### SPECIFICATIONS

Product type	Reducer Flange
Colour	black
Material	steel
Surface	painted
Threaded connector	3/8" x 12 mm
Suitable for tube diameter	35 mm
Type of adjustment	Screw clamp
Length	100 mm



## SPS36S16

ADAPTER FLANGE 36MM TO 16MM

### SPECIFICATIONS

Product type	Reducer Flange
Colour	black
Material	steel
Surface	powder coated
Suitable for tube diameter	35 mm
Reduced to	16 mm
Type of adjustment	Screw clamp
Length	140 mm



## SPS36TV28

REDUCER FLANGE 36MM TO 28MM (TV  
SPIGOT)

### SPECIFICATIONS

Product type	Reducer Flange
Colour	black
Material	steel
Surface	painted
Suitable for tube diameter	35 mm
Type of adjustment	Screw clamp
Length	130 mm
Other features	adjustable Joint with Wing Nut

# MONITOR STANDS



## SKDB039

SPEAKER STAND

### SPECIFICATIONS

Product type	Speaker stand
Tubing material	steel
Tubing colour	black
Tubing surface	powder coated
Min. height	915 mm
Max. height	1500 mm
Joint material	plastic
Tubing diameter	41/35 mm
Max. load	35 kg
Additional information	Footprint 450 x 390 mm



## SPADECO1

ISOLATION PAD FOR STUDIO MONITORS 170 X 300 MM

The ah PAD series is designed to isolate studio monitors acoustically, i.e., avoid disturbing resonances with the surface on which they stand, which results in a significantly improved sound. The two-component design results in three possible combinations (horizontal placement + two different angles).

### SPECIFICATIONS

Product type	Isolation pad for studio monitors
Material	High density acoustic foam
Colour	charcoal
Setup	2-layer
Width	170 mm
Height	40 mm
Depth	300 mm



## SPADECO2

ISOLATION PAD FOR STUDIO MONITORS 265 X 330 MM

The ah PAD series is designed to isolate studio monitors acoustically, i.e., avoid disturbing resonances with the surface on which they stand, which results in a significantly improved sound. The two-component design results in three possible combinations (horizontal placement + two different angles).

### SPECIFICATIONS

Product type	Isolation pad for studio monitors
Material	High density acoustic foam
Colour	charcoal
Setup	2-layer
Width	265 mm
Height	40 mm
Depth	330 mm







## **MICROPHONE STANDS**

Featuring rugged construction and reliable clutches, our microphone stands are available with tripod or weighted bases and in tabletop versions. Mic clips, shock mounts and pop filters complete the range.

# MICROPHONE STANDS



## S22

### MICROPHONE STAND WITH ROUND BASE

Steady Microphone stand with round cast base black

#### SPECIFICATIONS

Product type	microphone stand
Tubing material	steel
Tubing colour	black
Tubing surface	powder coated
Min. height	900 mm
Max. height	1600 mm
Base material	cast iron
Boom	no



## S5B

### MICROPHONE STAND WITH BOOM ARM

Microphone stand black with movable boom arm  
plastic-covered metal base with folding legs

#### SPECIFICATIONS

Product type	microphone stand
Tubing material	steel
Tubing colour	black
Tubing surface	powder coated
Min. height	940 mm
Max. height	1600 mm
Base material	steel / plastic
Boom	yes
Boom length	79 mm



## S5BE

### MICROPHONE STAND BLACK WITH BOOM ARM

#### SPECIFICATIONS

Product type	microphone stand
Tubing material	steel
Tubing colour	black
Tubing surface	powder coated
Min. height	980 mm
Max. height	1620 mm
Transport length	960 mm
Base material	plastic
Boom	yes
Boom length	760 mm



# MICROPHONE STANDS



## S6B

MICROPHONE STAND WITH BOOM ARM

- Microphone stand black
- telescopic boom arm
- plastic-covered metal base with folding legs

### SPECIFICATIONS

Product type	microphone stand
Tubing material	steel
Tubing colour	black
Tubing surface	powder coated
Min. height	940 mm
Max. height	1600 mm
Base material	Cast
Boom	yes
Boom length	500 - 800 mm
Additional information	with extendable boom



## S7B

MICROPHONE STAND WITH ROUND BASE AND BOOM ARM

Small microphone stand black with massive round cast base

### SPECIFICATIONS

Product type	microphone stand
Tubing material	steel
Tubing colour	black
Tubing surface	powder coated
Min. height	400 mm
Max. height	400 mm
Base material	cast iron
Boom	yes
Boom length	480 - 800 mm
Additional information	extendable boom



## S9B

MICROPHONE STAND SMALL WITH BOOM ARM

Small black microphone stand with extendable boom.

### SPECIFICATIONS

Product type	microphone stand
Tubing material	steel
Tubing colour	black
Tubing surface	powder coated
Min. height	500 mm
Max. height	500 mm
Base material	Cast
Boom	yes
Boom length	500 - 800 mm
Additional information	with extendable boom

# MICROPHONE STANDS



## S4B

### TABLETOP MICROPHONE STAND

Innovative, fully foldable table microphone stand.

#### SPECIFICATIONS

Product type	Table Stand
Colour	black
Material	steel
Threaded connector	3/8"
Height	170 mm



## S8B

### TABLETOP MICROPHONE STAND

Table microphone stand including microphone holder

#### SPECIFICATIONS

Product type	Table Stand
Tubing material	steel
Tubing colour	black
Tubing surface	powder coated
Min. height	150 mm
Max. height	200 mm
Additional information	Collapsible tabletop microphone stand



## S8BB

### TABLETOP MICROPHONE STAND

Stable microphone stand with base plate made of cast steel. The round base is equipped with rubber feet for soundproofing. The tube can be detached and has a 3/8" thread.

#### SPECIFICATIONS

Product type	Table Stand
Tubing material	steel
Tubing colour	black
Tubing surface	powder coated
Max. height	175 mm
Base material	cast iron
Boom	no

# MICROPHONE ACCESSORIES



## SMICBAG

TRANSPORT BAG FOR 2  
MICROPHONE STANDS

### SPECIFICATIONS

Product type	bag
Colour	black
Material	nylon
Dimensions (L x Ø):	105 cm x 12cm



## D800

ADAPTER 5/8" TO 3/8"

Thread adapter for mic holder 5/8" to  
3/8" chrome plated

### SPECIFICATIONS

Product type	Adapter thread
Material	steel
Surface	chromium plated
Internal thread size(s)	3/8"
External thread size(s)	5/8"



## D801

ADAPTER 3/8" TO 5/8"

Thread adapter for mic holder 5/8" to  
3/8" chrome plated

### SPECIFICATIONS

Product type	Adapter thread
Material	steel
Surface	chromium plated
Internal thread size(s)	5/8"
External thread size(s)	3/8"



## D902

MICROPHONE HOLDER FOR  
WIRELESS MICROPHONES

Large Microphone Holder, black with  
rubberised flexible top to fit most  
Radiomicrophones, Quick release. 3/8"  
and 5/8" thread.

### SPECIFICATIONS

Product type	Microphone Holder
Material	plastic
Thread	5/8"
Microphone mount (diameter)	29 mm
Joint	screw-on, adjustable
Additional information:	5/8" to 3/8" adaptor included



## D903

MICROPHONE HOLDER

Microphone Holder, black with  
rubberised flexible top to fit most  
microphones

### SPECIFICATIONS

Product type	Microphone Holder
Type	3/8" and 5/8" thread
Material	plastic
Threaded connector	5/8"
Microphone mount (diameter)	23 mm
Joint	screw-on, adjustable
Additional information:	5/8" to 3/8" adaptor included



## D905

MICROPHONE HOLDER FOR  
WIRELESS MICROPHONES

Pro Stage rubberised microphone holder  
for Radio microphones with new fins for  
perfect grip of the microphone. 3/8" and  
5/8" thread adapter.

### SPECIFICATIONS

Product type	including adapter 5/8" to 3/8"
Type	Microphone Holder
Material	3/8" and 5/8" thread
Threaded connector	plastic
Microphone mount (diameter)	33mm
Joint	screw-on, adjustable
Additional information:	5/8" to 3/8" adaptor included

# MICROPHONE ACCESSORIES



## D906

### MICROPHONE HOLDER

#### SPECIFICATIONS

Product type	Microphone Holder
Type	3/8" and 5/8" thread
Material	plastic
Threaded connector	5/8"
Threaded connector	3/8"
Microphone mount (diameter)	23 mm
Joint	screw-on, adjustable
Additional information:	5/8" to 3/8" adaptor included



## D907

### MICROPHONE HOLDER FOR WIRELESS MICROPHONES

#### SPECIFICATIONS

Product type	Microphone Holder
Type	3/8" and 5/8" thread
Material	plastic
Threaded connector	5/8"
Threaded connector	3/8"
Microphone mount (diameter)	32 mm
Joint	screw-on, adjustable
Additional information:	5/8" to 3/8" adaptor included



## D910

### POP FILTER

For all standard microphone stands, double nylon screen with sturdy black. Plastic frame attaches to stands with tubing up to 23 mm.

#### SPECIFICATIONS

Product type	Pop filter
Colour	black
Gooseneck length	270 mm
Gooseneck diameter	8 mm
Screen diameter	130 mm
Setup	plastic frame, double nylon screen
Fits tube diameters up to	23 mm



## D914

### POP FILTER

For all standard microphone stands, double nylon screen with sturdy black. Plastic frame attaches to stands with tubing up to 23 mm.

#### SPECIFICATIONS

Product type	Pop filter
Colour	black
Gooseneck length	330 mm
Gooseneck diameter	8 mm
Screen diameter	190 mm
Setup	plastic frame, double nylon screen
Fits tube diameters up to	23 mm

NEW!



## D921 /BLK

### GOOSENECK MOUNTING PLATE

Gooseneck mounting plate with 3/8" thread to attach microphone goosenecks.

- incl. Matching mounting screws
- Dimensions 30 x Ø 45 mm

#### SPECIFICATIONS

Surface	chromium plated/ powder coated
Material	steel
Colour	silver / black



## DSM400

### MICROPHONE SHOCK MOUNT WITH POP FILTER

Microphone Shock Mount with Pop filter for microphone stands with 5/8" Thread

#### SPECIFICATIONS

Product type	Microphone Shock Mount
Colour	black
Fits microphone diameter	43 mm
Threaded connector	5/8"
Other features	including 130 mm Pop Filter

# MICROPHONE ACCESSORIES



## DSM40B

MICROPHONE SHOCK MOUNT  
40 - 44 MM BLACK

### SPECIFICATIONS

Product type	Microphone Shock Mount
Colour	black
Fits microphone diameter	40 mm
Threaded connector	5/8"



## DSM45B

MICROPHONE SHOCK MOUNT  
45 - 49 MM BLACK

### SPECIFICATIONS

Product type	Microphone Shock Mount
Colour	black
Fits microphone diameter	45 mm
Threaded connector	5/8"



## SDMSB190

STEREO BAR FOR 2 MICROPHONES

Stereo bar for 2 microphones, mountable to microphone stands with 3/8" threaded connector.

### SPECIFICATIONS

Product type	Microphone bar
Material	aluminium
Colour	black
Horizontal adjustment range	60 mm - 170 mm
Threaded connector	3/8"
Material thickness	4 mm
Length	190 mm



A high-contrast, black and white close-up photograph of a metal lighting stand component. The image shows a bolt and nut assembly on a curved metal arm, with a textured surface. The lighting is dramatic, highlighting the metallic textures and the mechanical details of the hardware.

## **LIGHTING STANDS**

Our lighting stands put your fixtures up where they belong. The selection includes a truss and tripod set, convenient wind-up stands, T-bars and accessories such as TV spigots and 35 mm pole adapters.

# LIGHTING STANDS



## SWU375

WIND UP STAND BLACK

The TÜV-certified SWU375 is a professional wind up stand for mobile and stationary use.

### SPECIFICATIONS

Product type	Lighting Stand
Stand material	steel
Stand surface	powder coated
Stand colour	black
Number of extensions	2
Min. height	1730 mm
Max. height	3750 mm
Transport length	1900 mm
Max. load	30 kg
Holding fixture for TV Spigot	yes
TV spigot	16 - 28 mm
Additional information	TÜV-certified, Wind up stand



## SWU375FR

STEP FOR SWU 375 WIND UP STAND BLACK

### SPECIFICATIONS

Product type	Climbing aid for lighting stand
Colour	black
Material	aluminium
Surface	powder coated



# LIGHTING STANDS



## SWU400T

WIND UP STAND WITH T-BAR BLACK

The SWU400T is an affordable lighting stand that features convenient height adjustment by means of a hand crank. Thanks to its high load bearing capacity of 85 kg, the removable crossbar, and the upper tube with a diameter of 35 mm, the SWU400T is also suitable for use as a speaker stand.

The sturdy steel construction has a black powder-coated finish; the upper tube and extensions are galvanized. A levelling foot ensures secure positioning of the wind up stand even on uneven surfaces. All adjustable elements are secured with spring bolts in addition to the tommy screws. The SWU400T weighs 19.7 kg and is extendable from a minimum height of 190.5 cm to a maximum of 4m.

### SPECIFICATIONS

Product type	Lighting Stand
Stand material	steel
Truss material	steel
Stand surface	powder coated
Stand surface	galvanized
Crossbar surface	powder coated
Stand colour	silver
Stand colour	galvanized
Crossbar colour	black
Number of extensions	1
Min. height	1905 mm
Max. height	4000 mm
Transport length	1735 mm
Max. load	85 kg
Additional information	incl. crossbar



## SLSTRS400

TRUSS AND TRIPOD WIND-UP STAND SET

The tripod wind-up stands with T-bar truss supports are made of heavy duty steel, and the sturdy winch mechanism facilitate convenient lifting to a maximum height of 4 m or lowering to the minimum 1.6 meters. The extension tubes are additionally secured by strong safety pins.

Product type	Lighting Stand
Stand material	steel
Truss material	steel
Stand surface	powder coated
Crossbar surface	powder coated
Stand colour	black
Crossbar colour	black
Truss design	3-point
Number of extensions	1
Min. height	1600 mm
Max. height	3000 mm
Transport length	1600 mm
Max. load	100 kg
Holding fixture for TV Spigot	no
Crossbar length	3000 mm

# LIGHTING STANDS



## SLS6

### LIGHTING STAND

Lightweight lighting stand, 2 stages with T-crossbar

#### SPECIFICATIONS

Product type	Lighting Stand
Stand material	steel
Truss material	steel
Stand surface	powder coated
Crossbar surface	powder coated
Stand colour	black
Number of extensions	2
Min. height	1240 mm
Max. height	2730 mm
Transport length	1080 mm
Max. load	25 kg
Holding fixture for TV Spigot	yes
Crossbar length	920 mm
Tiltable crossbar	no
TV spigot	17 mm



## SLS6CB

### LIGHTING STAND T-BAR WITH 17 MM TV SPIGOT

This square T-bar fits onto all lighting stands with 17 mm sockets. It features 4 fixture mounting points and holds up to 25 kg evenly distributed. The 92 cm T-bar comes with a set of matted M8 x 45 mm bolts and wing nuts.

#### SPECIFICATIONS

Product type	T-bar with 17 mm TV spigot
Material	steel
Surface	powder coated
Colour	black
Length	920 mm
Max. load	25 kg

# LIGHTING STANDS



## SLTS09

LIGHTING STAND MEDIUM

### SPECIFICATIONS

Product type	Lighting Stand
Stand material	steel
Truss material	steel
Stand surface	powder coated
Crossbar surface	powder coated
Stand colour	black
Crossbar colour	black
Number of extensions	2
Min. height	1400 mm
Max. height	3200 mm
Transport length	1260 mm
Max. load	30 kg
Holding fixture for TV Spigot	yes
Crossbar length	1060 mm
TV spigot	23 mm



## SLTS09CB

LIGHTING STAND T-BAR WITH 23 MM TV SPIGOT

This square T-bar fits onto all lighting stands with 23 mm sockets and is a direct replacement for our AH-Stand SLTS09. It features 4 fixture mounting points and holds up to 30 kg evenly distributed. The 106 cm T-bar comes with a set of matted M8 x 45 mm bolts and wing nuts.

### SPECIFICATIONS

Product type	T-bar with 23 mm TV spigot
Material	steel
Surface	powder coated
Colour	black
Length	1060 mm
Max. power handling	30 kg

# LIGHTING STANDS



## SLTS017

LIGHTING STAND LARGE WITH TV SPIGOT ADAPTER

### SPECIFICATIONS

Product type	Lighting Stand
Stand material	steel
Truss material	steel
Stand surface	powder coated
Crossbar surface	powder coated
Stand colour	black
Crossbar colour	black
Number of extensions	2
Min. height	1700 mm
Max. height	3500 mm
Transport length	1410 mm
Max. load	45 kg
Holding fixture for TV Spigot	yes
Crossbar length	1230 mm
Tiltable crossbar	no
TV spigot	28 mm



## SLTS017CB

LIGHTING STAND T-BAR WITH 28 MM TV SPIGOT

This square T-bar fits onto all lighting stands with 28 mm sockets and is a direct replacement for our AH-Stand SLTS017 and SLTS017E. It features 4 fixture mounting points and holds up to 45 kg evenly distributed. The 123 cm T-bar comes with a set of matted M8 x 45 mm bolts and wing nuts.

### SPECIFICATIONS

Product type	T-bar with 28 mm TV spigot
Material	steel
Surface	powder coated
Colour	black
Length	1230 mm
Max. power handling	45 kg



## SLTS017E

LIGHTING STAND LARGE WITH TV SPIGOT ADAPTER

Lighting Stand large with holding fixture for 28 mm TV Spigot

### SPECIFICATIONS

Product type	Lighting Stand
Stand material	steel
Truss material	steel
Stand surface	powder coated
Crossbar surface	powder coated
Stand colour	black
Crossbar colour	black
Number of extensions	2
Min. height	1700 mm
Max. height	3500 mm
Transport length	1410 mm
Max. load	45 kg
Holding fixture for TV Spigot	yes

# LIGHTING STANDS



## SLSTV28M10

28 MM TV SPIGOT WITH M10 THREAD

- M10 x 34 mm thread
- 115 mm total length
- High-grade aluminium

### SPECIFICATIONS

Product type	adapter
Material	aluminium
Surface	plain
Diameter	28 mm
Length	115 mm
Thread size	M10 x 34 mm



## SLS36TV28

ADAPTER 28 MM (TV SPIGOT) TO 35 MM

- Adaptor TV28 to 35mm
- Mount speakers to lighting stands
- Zinc coated steel

### SPECIFICATIONS

Product type	T-bar with 17 mm TV spigot
Material	steel
Surface	powder coated
Colour	black
Length	920 mm
Max. power handling	25 kg



## CBSCREWSET

T-BAR NUT AND BOLT SET

This set includes 4 matted M8 x 45 mm bolts and wing nuts for mounting light fixtures to T-bars.

- Set of four M8 bolts and wing nuts,
- Thread length 45 mm

# LIGHTING STANDS



## SLTSBAG

TRANSPORT BAG FOR 2 LIGHTING STANDS

### SPECIFICATIONS

Product type	bag
Material	polyester
Colour	black
Length	1500 mm
Features	with Zipper, water-repellent



## SLSCB1

TRIPOD LATERAL CROSSBAR FOR UP TO 4 LIGHTS

- Mount up to 4 additional lights
- Optional supporting strut included
- Maximum load 8kg (16kg with strut)
- Lightweight sturdy aluminium construction

### SPECIFICATIONS

Product type	Lateral crossbar
Material	aluminium
Colour	black
Max number of projectors	4
Suitable for tube diameter	35 mm
Diameter	36 mm
Max. power handling	(without brace) 8 kg / (with brace) 16 kg
Tube length	550 mm









## LAPTOP STANDS

Our fully adjustable laptop stands fit into most gig bags and can be assembled and disassembled very easily. With shelves for hard drives or interfaces they are ideal for DJs and lighting control.



# LAPTOP STANDS



## SLT001 / W

### LAPTOP STAND WITH CLAMP

Thanks to its adjustable height & width the Adam Hall Laptop Stand offers every DJ flexibility to the fullest!

#### SPECIFICATIONS

Product type	Laptop Stand
Material	steel
Surface	powder coated
Colour	black / white
Depth	250 mm
Min. width	235 mm
Max. width	290 mm
Min. height	165 mm
Max. height	280 mm
Additional information	with screw clamps for fastening to horizontal and vertical surfaces



## SLT001E / W

### LAPTOP STAND

This tabletop stand is ideal to place your laptop, CD player or lighting controller into a convenient operating position. It holds equipment with a width of 22.5 cm or greater and is easily height adjustable from 17 to 34 cm. The stand is made of steel with a powder coat finish and fully collapsible for space-saving transport.

#### SPECIFICATIONS

Product type	Laptop Stand
Material	steel
Surface	powder coated
Colour	black / white
Depth	250 mm
Max. width	225 mm
Min. height	170 mm
Max. height	340 mm



## SLT001TRAY

### STORAGE TRAY FOR LAPTOP STANDS SLT001 / SLT001E

#### SPECIFICATIONS

Product type	Accessory shelf
Material	steel
Colour	black
Material thickness	2
Width	adjustable 237 - 300 mm

# LAPTOP STANDS



## SLT006B / S

FOLDABLE LAPTOP STAND WITH TRAY BLACK

The Adam Hall SLT006 laptop stand is lightweight, strong, compact, flexible and last but not least elegant. The stand can be set up and dismantled in a matter of seconds and can even fit in a laptop bag. The lower shelf can be adjusted in four height increments and is ideal for the storage of accessories such as an audio interface.

### SPECIFICATIONS

Product type	Laptop Stand
Material	aluminium
Surface	powder coated
Colour	black / silver
Depth	250 mm
Max. width	220 mm
Max. height	300 mm
Height of Lower Shelf	220 mm, 190 mm, 110 mm, 80 mm
Additional information	including transport bag



## SLT003

LAPTOP STAND

- Extremely rugged tripod laptop stand
- Adjustable height
- Adjustable-tilt plate

### SPECIFICATIONS

Product type	Laptop Stand
Material	steel
Surface	powder coated
Colour	black
Depth	290 mm
Max. width	390 mm
Min. height	900 mm
Max. height	1350 mm
Additional information	Tripod Stand



A close-up, high-angle photograph of a metal keyboard stand joint. The image shows several thick, polished metal bars intersecting at a central point. Two large, circular adjustment knobs are visible, one of which is being turned by a hand. The lighting is dramatic, highlighting the metallic surfaces against a dark background.

## **KEYBOARD STANDS**

Providing sturdy support, our single and double X-braced or two-tier keyboard stands are easily adjustable for the perfect height. For sit-down players we offer a choice of folding keyboard benches.

# KEYBOARD STANDS



## SKS01

KEYBOARD STAND

### SPECIFICATIONS

Product type	Keyboard stands
Material	steel
Surface	powder coated
Colour	black
Decks	1
Max. support depth	400 mm
Min. height	600 mm
Max. height	1000 mm
Max load (support)	30 kg
Additional information	X-Frame Keyboard Stand with Quick Adjustment



## SKS024

KEYBOARD STAND EXTENSION / STACKER

### SPECIFICATIONS

Product type	Extension
Material	aluminium
Colour	black
For tubes with inner diameter	22 mm



## SKS03

KEYBOARD STAND

Stable keyboard stand with square-section double bracing and quick adjustment

### SPECIFICATIONS

Product type	Keyboard stands
Material	steel
Surface	powder coated
Colour	black
Decks	1
Max. support depth	480 mm
Min. height	600 mm
Max. height	1000 mm
Max load (support)	40 kg
Additional information	X-Frame Keyboard Stand with Quick Adjustment



## SKS04

KEYBOARD STAND BLACK

### SPECIFICATIONS

Product type	Keyboard stands
Material	steel
Surface	powder coated
Colour	black
Decks	1
Max. support depth	400 mm
Min. height	640 mm
Max. height	980 mm
Max load (support)	30 kg
Additional information	5 levels of height adjustment, compact dimensions



## SKS05

UNIVERSAL STAND FOR KEYBOARDS AND EQUIPMENT

### SPECIFICATIONS

Product type:	keyboard stand
Material:	steel
Surface:	powder-coated
Colour:	black
Construction:	scissor technology
Height adjustment:	Locking function for height adjustment
Number of Supports:	1
Max. Load:	50 kg
Height:	610 mm – 850 mm
Gradation:	6-position adjustable
Max. width:	up to 750 mm
Depth base columns:	460 mm
Depth supporting surface:	310 mm
<b>Transport dimensions</b>	
Height x width x depth:	610 mm x 80 mm x 460 mm
Weight:	3.55 kg

# KEYBOARD STANDS



## SKS22XB

DOUBLE KEYBOARD STAND

### SPECIFICATIONS

Product type	Keyboard stands
Material	aluminium
Surface	powder coated
Colour	black
Decks	2
Max. support depth	380 mm
Min. height	1170 mm
Max. height	1170 mm
Max load (support)	35 (per level) kg

Additional information

Feet and arms can be folded into the stand, height continuously adjustable from 22-110 cm



## SKS22MB

BOOM ARM FOR SKS22XB KEYBOARD STAND 2-PIECE EXTENDABLE

### SPECIFICATIONS

Product type	Boom Arm
Tube material	steel
Tube surface	powder coated
Tube colour	black
Tube length	800 mm
Threaded connector	5/8 "
Type of adjustment	Screw clamp
Length	140 mm



## SKS22XBAG

GIG BAG FOR DOUBLE KEYBOARD STAND SKS22XB

- M10 x 34 mm thread
- 115 mm total length
- High-grade aluminium

### SPECIFICATIONS

Product type	bag
Material	nylon
Colour	black



## SKT16E

FOLDING KEYBOARD BENCH

### SPECIFICATIONS

Product type	Keyboard bench
Tube material	steel
Tubing surface	powder coated
Tubing colour	black
Min. height	430 mm
Max. height	480 mm
Seat material	plastic
Seat colour	black
Seat width	450 mm
Seat length	305 mm



## SKT17

FOLDING KEYBOARD BENCH WITH EXTRA THICK PADDING

### SPECIFICATIONS

Product type	Keyboard bench
Tube material	steel
Tubing surface	powder coated
Tubing colour	black
Min. height	490 mm
Max. height	580 mm
Seat material	plastic
Seat colour	black
Seat width	530 mm
Seat length	240 mm







## **GUITAR STANDS**

Our universal guitar stands are designed for a firm footing with a slight back angle that improves overall balance and support. They accommodate most acoustic and electric guitars and basses.

# GUITAR STANDS



## SGS017

FOOTREST FOR GUITARISTS

### SPECIFICATIONS

Product type	Footrest
Material	metal
Colour	black
Height adjustment	4 increments
Height	120 mm
Width	100 mm
Length	250 mm



## SGS101

GUITAR STANDS

- Universal guitar stand for acoustic and electric guitars, black, with NECK LATCH
- Very stable stand
- Soft foam covered neck and body support
- Not recommended for guitars with nitro laquer.

### SPECIFICATIONS

Product type	guitar stand
Material	steel
Surface	powder coated
Colour	black
Suitable for	electric guitars
Suitable for	acoustic guitars
Suitable for	Bass



## SGS103

UNIVERSAL GUITAR STAND

- Universal guitar stand for acoustic and electric guitars.
- Not recommended for guitars with nitro laquer.

### SPECIFICATIONS

Product type	guitar stand
Material	steel
Surface	powder coated
Colour	black
Suitable for	electric guitars
Suitable for	acoustic guitars

# GUITAR STANDS



## SGWH1

### GUITAR WALL HANGER

- High-quality rubber foam protective covering
- Opening width: 55 mm
- Screws not included
- Not recommended for guitars with nitro laquer.

#### SPECIFICATIONS

Product type	Guitar wall hanger
Material	steel
Surface	powder coated
Colour	black
Suitable for	electric guitars, acoustic guitars



## SCBCLMP

### CABINET CLAMP FOR MICROPHONE

#### SPECIFICATIONS

Product type	Microphone Holder
Tubing material	steel
Tubing surface	powder coated
Tubing colour	black
Clamping width	195 - 350 mm
Gooseneck length	180 mm
Threaded connector	3/8"





## **MUSIC STANDS**

Featuring lightweight perforated desks with variable tilt, our tripod music stands are made of hardwearing steel for durability. They are easily height adjustable for sitting or standing positions.

# MUSIC STANDS



## SMS17

### MUSIC STAND

Professional, very stable, sturdy music stand for use in bands, orchestras or on the stage.

#### SPECIFICATIONS

Product type	Music stand
Music desk type	perforated music desk
Stand material	steel
Stand surface	powder coated
Stand colour	black
Support material	steel
Support surface	powder coated
Support colour	black
Support width	470 mm
Support height	340 mm
Min. height	700 mm
Max. height	1200 mm



## SMS19

### MUSIC STAND

Professional, very sturdy music stand with V-shaped prismatic connector between tripod and sheet music support. Suitable for use in bands, orchestras or on the stage.

#### SPECIFICATIONS

Product type	Music stand
Music desk type	perforated music desk
Stand material	steel
Stand surface	painted
Stand colour	black
Support material	steel
Support surface	painted
Support colour	black
Support width	340 mm
Support height	475 mm
Min. height	660 mm
Max. height	1200 mm

# MUSIC STANDS

NEW!



## SMS2

### PERFORATED MUSIC STAND

The SMS 2 features a perforated sheet music support and folding tripod base of hard-wearing steel with durable black powder coating finish. Stand height and desk tilt angle are fully adjustable for use when seated or standing. The folding design and detachable desk tray to facilitate storage and transport.

#### SPECIFICATIONS

Product type	Music stand
Music desk type	perforated music desk
Stand material	steel
Stand surface	powder coated
Stand colour	black
Support material	steel
Support surface	powder coated
Support colour	black
Support width	470 mm
Support height	340 mm
Transport length	600 mm



## SMS11

### FOLDING MUSIC STAND

Space saving collapsible music stand - ideal for taking along in your instrument case.

#### SPECIFICATIONS

Product type	Music stand
Music desk type	folding
Stand material	steel
Stand surface	powder coated
Stand colour	black
Support material	steel
Support surface	powder coated
Support colour	black
Support width	465 mm
Support height	230 mm
Min. height	740 mm
Max. height	1380 mm
Additional information	incl. bag

# MUSIC STANDS

NEW!



## SMS11PRO

TELESCOPIC MUSIC STAND, SMALL INCL. BAG

Professional and very stable, sturdy music stand for use by bands, orchestras or on stage. Thanks to its well designed compactness, it is very versatile and also the ideal companion for travelling.

- Compact and lightweight music stand with double extension
- Quick to assemble
- Height continuously adjustable from 69-138 cm
- Super compact transport size 48 x 25
- Sturdy and durable design
- Built for maximum stability
- The shelf can be used vertically as well as horizontally
- Practical bag for the protection and safe transportation of your music stand

### SPECIFICATIONS

Product Type:	music stand
Material:	steel
Colour:	black
Surface:	powder-coated
Shelf Width:	400 mm
Shelf Height:	250 mm
Weight:	1.7 kg
Additional Information:	Incl. transport bag



# MUSIC STANDS



## SMS17SET1

MUSIC STAND WITH LED LIGHT

The SLED2Pro is a compact, handy light with a patented design intended for music stands. The 4 bright and efficient LEDs can be switched individually between 2 brightness levels. Also, the light cone is adjustable thanks to the flexible 220 mm long goosenecks. Due to its long operating time, it is also suitable as a mobile reading lamp and multifunctional clip light for all lighting needs at home and on the go.

### SPECIFICATIONS

Product type	set
<b>Product type</b>	<b>Music stand</b>
Music desk type	perforated music desk
Stand material	steel
Stand surface	powder coated
Stand colour	black
Support material	steel
Support surface	powder coated
Support colour	black
Support width	470 mm
Support height	340 mm
Min. height	700 mm
Max. height	1200 mm

<b>Product type</b>	<b>Gooseneck Lamp</b>
Number of LEDs	4
Colour of LEDs	white
Gooseneck length	220 mm
Switches	yes
Switch levels	off, 2 LED, 1 LED
Colour temperature	6000 - 6500 K
Power Supply	battery
Optional power supply with power adapter	yes
Fitting	Spring clamp
Additional information	Incl. 3 AAA batteries



## **MUSIC LIGHTS**

With our selection of clip-on LED music lights we provide the perfect illumination for reading sheet music. Featuring a choice of connectors our gooseneck lights are ideal for stage and studio use.

# MUSIC LIGHTS



## SLED10

### LED LIGHT FOR MUSIC STAND

The SLED10 is a very compact and handy light with a patented design intended for music stands. The 10 bright and efficient LEDs can be switched individually between 2 brightness levels. Also, the light cone is adjustable thanks to the flexible 220 mm long gooseneck. Due to its long operating time, it is also suitable as a mobile reading lamp and multifunctional clip light for all lighting problems at home and on the go.

- 10 white LEDs
- Two-way adjustable brightness
- Significantly lower power / battery consumption than other music stand lights
- Clip mount
- Incl. power pack, carrying case and batteries (3 x 1.5 V AA)
- Dimensions (folded): 215 x 165 x 125 mm

### SPECIFICATIONS

Product type	Gooseneck Lamp
Number of LEDs	10
Colour of LEDs	white
Gooseneck length	240 mm
Switches	yes
Switch levels	low
Switch levels	high
Switch levels	off
Colour temperature	6000 K
Illuminance	1061 / 800 lx +/- 100 lx@1m
Power Supply	3 AA batteries
Optional power supply with power adapter	yes
Fitting	Spring clamp
Additional information	Incl. power pack, carrying case and batteries, UK Version available: SLED10UK



## SLEDPL10B

### LED PIANO LAMP WITH 10 LEDS

The SLED PL 10 B is a compact, handy light with a patented design intended as piano / keyboard light. The 10 bright and efficient LEDs can be switched individually between 2 brightness levels. Also, the light dispersion is adjustable thanks to the flexible 380mm long gooseneck. Thanks to the 1.3kg round base, the lamp has a secure stand. A power supply with a 3m cord is included.

### SPECIFICATIONS

Product type	Gooseneck Lamp
Number of LEDs	10
Colour of LEDs	white
Gooseneck length	380 mm
Total length	380 mm
Switches	yes
Switch levels	off
Switch levels	low
Switch levels	high
Colour temperature	6000 K - 6500 K
Illuminance	1061 / 800 lx +/- 100 lx@1m
Power Supply	5 VDC adaptor included
Fitting	Base weight
Additional information	Gooseneck

# MUSIC LIGHTS



## SLED1PRO

### LED LIGHT FOR MUSIC STAND

The SLED1Pro is a compact, handy light with a patented design intended for music stands. The 2 bright and efficient LEDs can be switched individually between 2 brightness levels. Also, the light cone is adjustable thanks to the flexible 220 mm long gooseneck. Due to its long operating time, it is also suitable as a mobile reading lamp and multifunctional clip light for all lighting needs at home and on the go.

### SPECIFICATIONS

Product type	Gooseneck Lamp
Number of LEDs	2
Colour of LEDs	white
Gooseneck length	220 mm
Switches	yes
Switch levels	1 LED, 2 LED, off
Colour temperature	6000 K
Power Supply	3 AAA batteries
Optional power supply with power adapter	yes
Fitting	Spring clamp
Additional information	incl. batteries



## SLED2PRO / W

### LED LIGHT FOR MUSIC STAND

The SLED2Pro is a compact, handy light with a patented design intended for music stands. The 4 bright and efficient LEDs can be switched individually between 2 brightness levels. Also, the light cone is adjustable thanks to the flexible 220 mm long goosenecks.

- Clip fastening for music stand
- Incl. Batteries (3 x AAA)
- Dimensions (folded): 110 x 60 x 50 mm

### SPECIFICATIONS

Product type	Gooseneck Lamp
Number of LEDs	4
Colour of LEDs	black / white
Gooseneck length	220 mm
Switches	yes
Switch levels	2 LED
Switch levels	1 LED
Switch levels	off
Colour temperature	6000 K - 6500 K
Power Supply	battery
Optional power supply with power adapter	yes
Fitting	Spring clamp
Additional information	Incl. 3 AAA batteries

# MUSIC LIGHTS



## SLED2ULTRA

### CLIP-ON DUAL GOOSENECK LIGHT

The SLED 2 ULTRA is a matt black clip-on light with dual goosenecks that are equipped with 4 white COB LEDs each. The 27 cm goosenecks provide flexible positioning and three individual brightness settings. The SLED 2 ULTRA comes with three AA batteries, a dedicated power adapter is optionally available.

#### SPECIFICATIONS

Product type	Gooseneck Lamp
Number of LEDs	8 COB
Colour of LEDs	white
Gooseneck length	270 mm
Switches	yes
Switch levels	3
Current draw	100 A
Power consumption	0.48 W
Power Supply	battery
Optional power supply with power adapter	yes
Fitting	Spring clamp
Additional information	Incl. 3 AA batteries



## SLED24PRO

### FOLDING LED MUSIC STAND LIGHT

Folding to ultra compact dimensions, the SLED 24 PRO music stand light provides uniform, glare-free illumination from a total of 24 warm white LEDs. The pivoting LED bar adjusts easily for optimum coverage, and the power switch includes three brightness level settings. Elegant and unobtrusive, the SLED 24 PRO features two padded spring clips for quick, secure attachment and can be mains, battery and USB powered. It comes with a 5 V DC adapter, three size AAA batteries and fits into any accessory pouch.

#### SPECIFICATIONS

Product type:	Music light
Number of LEDs:	24
Colour of LEDs:	Warm white
Switch levels:	On, High, Medium, Low, Off
Colour temperature:	3200K +/- 500K
USB Port:	Type A, DC 5V 1,5A
Power Supply:	3x AAA or 5VDC input
External Power supply:	Included
Dimensions (WxDxH):	180mm x 60mm x 35mm



## SLED1BULTRA

### GOOSENECK LIGHT WITH SURFACE MOUNT BASE

Featuring 4 extra bright white COB LEDs, a colour temperature of 6,500 K and convenient power switch the SLED 1 B ULTRA is a 30 cm gooseneck light with rugged surface mount base of black plastic and steel. The lamp includes a 500mA 12 volt DC power adapter.

#### SPECIFICATIONS

Product type	gooseneck light with mount base
Base material	steel/plastic
Number of LEDs	4
Colour of LEDs	white
Gooseneck length	300 mm
Switches	yes
Colour temperature	6000 K
Power consumption	0.24 W
Power Supply	12 VDC 500 mA power supply included
Width	34 mm
Height	92 mm
Depth	26 mm
Additional information	4 extra bright COB LEDs



## SLED1BXL3

### SURFACE MOUNT 3-PIN XLR GOOSENECK LIGHT BASE WITH POWER ADAPTER

Made of hard-wearing black plastic with a steel mounting plate the SLED 1 B XLR 3 is a gooseneck light base for lamps with a 3-pin male XLR connector. Pins 1 and 3 are wired to ground, pin 2 supplies +12 volts. The base comes with a 500mA 12 volt DC

#### SPECIFICATIONS

Product type	XLR gooseneck light base
Material	steel/plastic
Colour	black
Connection socket	XLR 3-pin female
Power Supply	12 VDC 500 mA power supply included
Width	34 mm
Height	92 mm
Depth	26 mm

# MUSIC LIGHTS



## SLED1USBPRO

USB GOOSENECK LAMP WITH 2 LEDS

The SLED1USBPRO is a compact, USB Gooseneck Light with 2 LEDs.

The 2 bright and efficient LEDs can be switched individually between 2 brightness levels. Also, the light cone is adjustable thanks to the flexible 200 mm long gooseneck. Works on any PC or MAC USB port and is therefore also ideal for working on the laptop, if you do not want to illuminate the whole room.

### SPECIFICATIONS

Product type	Gooseneck Lamp
Number of LEDs	2
Colour of LEDs	white
Gooseneck length	165 mm
Switches	yes
Switch levels	1 LED, 2 LED, off
Colour temperature	6000 K
Power Supply	via USB connector
Optional power supply with power adapter	no



## SLEDPSUSB

UNIVERSAL 5 V POWER ADAPTER USB/DC (DC PLUG)

Universal power supply including a USB to DC (DC Plug) cable 1.35 x 3.5 mm.

### SPECIFICATIONS

Product type	power supply
Cable length	2 m
Frequency	50 Hz
Input voltage	100 - 240 VAC
Output voltage	5 V DC +/-0.5 V, 800 mA +/-30 mA
Width	24 mm
Height	78 mm
Depth	57 mm
Accessories (included)	USB to 1.35 x 3.5 mm DC cable



## SLEDPSUSBK

UNIVERSAL 5 V POWER ADAPTER USB/DC (DC PLUG)

Universal power supply including a USB to DC (DC Plug) cable 1.35 x 3.5 mm.

### SPECIFICATIONS

Product type	power supply
Cable length	2 m
Frequency	50 Hz
Input voltage	100 - 240 VAC
Output voltage	5 V DC +/-0.5 V, 500 mA +/-30 mA
Width	24 mm
Height	78 mm
Depth	57 mm
Accessories (included)	USB to 1.35 x 3.5 mm DC cable, power supply



# MUSIC LIGHTS



## SLED1ULTRA### GOOSENECK LIGHT

NEW!

The SLED 1 ULTRA is a matt black gooseneck light with 4 extra bright white COB LEDs and 3-pin male XLR plug that works on dedicated 12 volt to 48 volt DC. The 300 mm gooseneck is easily flexible yet stays put where you bend it, the power switch is conveniently located on top of the lamp. Weight 0.08 kg.

Model name:	SLED1ULTRABNC	SLED1ULTRAUSB	SLED1ULTRAXLR3	SLED1ULTRAXLR3A	SLED1ULTRAXLR4	SLED1ULTRAXLR4A
Product type:	Gooseneck Lamp	Gooseneck Lamp	Gooseneck Lamp	Gooseneck Lamp	Gooseneck Lamp	Gooseneck Lamp
Number of LEDs	4	4	4	4	4	4
Colour of LEDs	white	white	white	white	white	white
Gooseneck length	300 mm	300 mm	300 mm	400 mm	300 mm	400 mm
Switches	yes	yes	yes	yes	yes	yes
Colour temperature	6000 to 6500 K	6000 to 6500 K	6000 to 6500 K	6000 to 6500K	6000 to 6500 K	6000 to 6500K
Pin assignment	-	-	XLR pins 1 and 3 = ground, pin 2 = +12 V	XLR pins 1 and 3 = ground, pin 2 = +12 V	XLR pins 1 and 2 not connected, pin 3 = ground, pin 4 = +12V	XLR pins 1 and 2 not connected, pin 3 = ground, pin 4 = +12V
Power Supply	via BNC connector	via USB connector	via 3-pin XLR connector	via angled 3-pin XLR connector	via 4-pin XLR connector	via angled 4-pin XLR connector
Weight	0.08 kg	0.08 kg	0.08 kg	0.09 kg	0.08 kg	0.09 kg
Additional information	4 extra bright COB LEDs	4 extra bright COB LEDs	4 extra bright COB LEDs	4 extra bright COB LEDs	4 extra bright COB LEDs	4 extra bright COB LEDs

# MUSIC LIGHTS



NEW!

## SLED1ULTRA###C GOOSENECK LIGHT WITH 4 COB LEDs AND SELECTABLE COLOURS

The SLED 1 ULTRA XLR 3 AC is a matt black gooseneck light with 4 extra bright white COB LEDs and 3-pin male angled XLR plug that works on dedicated 12 volt task light and 48 volt phantom power. The 300 mm gooseneck is easily flexible yet stays put where you bend it, the power switch is conveniently located on top of the lamp.

Model name:	SLED1ULTRAXLR3AC	SLED1ULTRAXLR3C	SLED1ULTRAXLR4AC	SLED1ULTRAXLR4C
Product type	Gooseneck Lamp	Gooseneck Lamp	Gooseneck Lamp	Gooseneck Lamp
Number of LEDs	4	4	4	4
Colour of LEDs	cold white, warm white, red, green, blue	cold white, warm white, red, green, blue	cold white, warm white, red, green, blue	cold white, warm white, red, green, blue
Gooseneck length	300 mm	300 mm	300 mm	300 mm
Switches	yes	yes	yes	yes
Pin assignment	XLR pins 1 and 2 not connected, pin 3 = ground, pin 4 = +12V	XLR pins 1 and 2 not connected, pin 3 = ground, pin 4 = +12V	XLR pins 1 and 2 not connected, pin 3 = ground, pin 4 = +12V	XLR pins 1 and 2 not connected, pin 3 = ground, pin 4 = +12V
Power consumption	0.24 W	0.24 W	0.24 W	0.24 W
Power Supply	via 3-pin XLR connector	via 3-pin XLR connector	via 4-pin XLR connector	via 4-pin XLR connector
Optional power supply with power adapter	yes	yes	yes	yes
Additional information	4 extra bright COB LEDs	4 extra bright COB LEDs	4 extra bright COB LEDs	4 extra bright COB LEDs

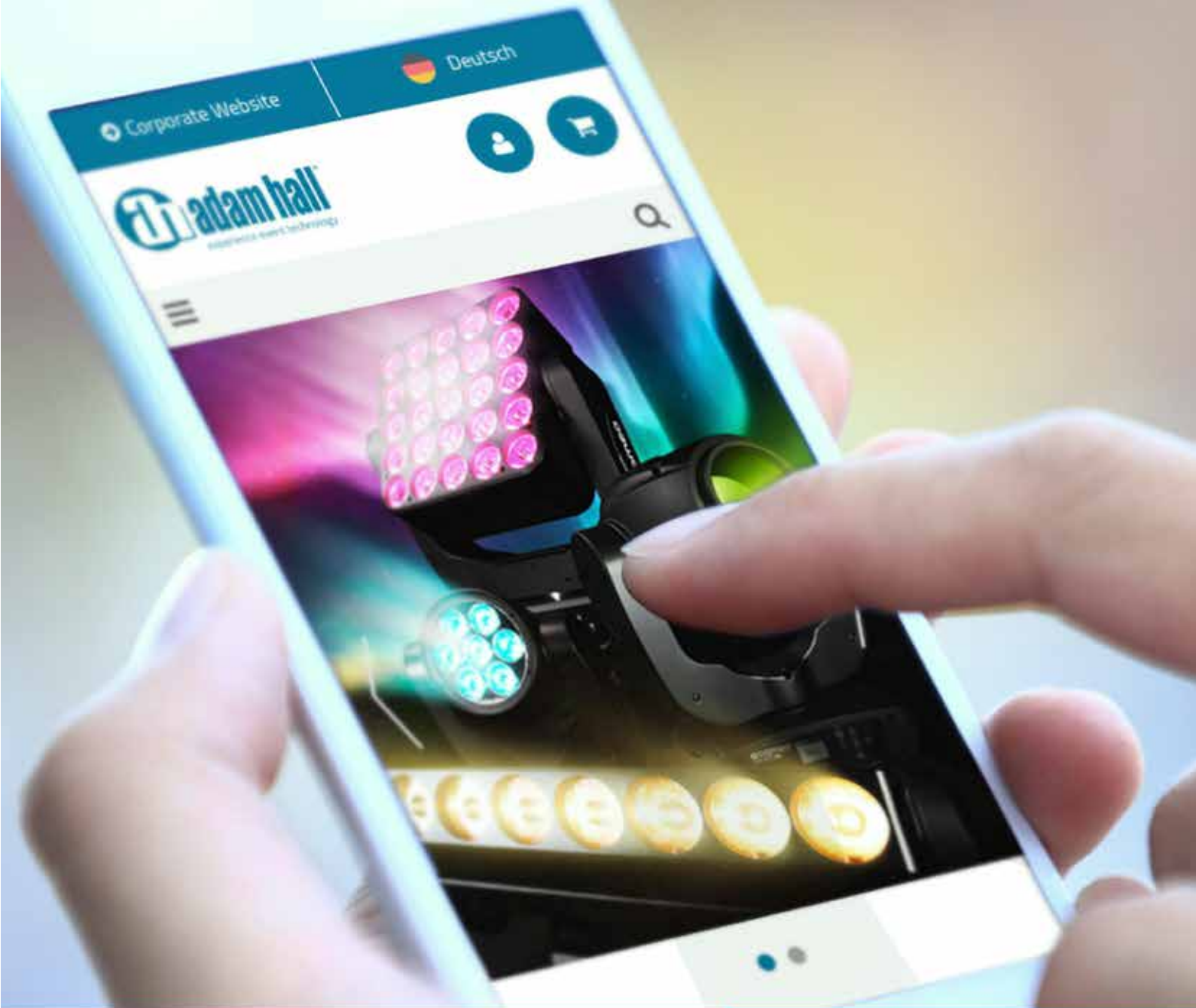

## Our B2B shop

Intuitively designed for you

-  Fast and secure shopping
-  High availability from one source
-  Reliable Adam Hall quality
-  Your trade prices available at all times
-  Exclusive deals and closeouts
-  Inventory levels in real time
-  New products at a glance

[www.shop.adamhall.com](http://www.shop.adamhall.com)

 **adam hall**  
experience event technology







## MISCELLANEOUS

Our 19" rack stands are the convenient alternative to rack cases or cabinets in fixed applications, and accessories like our iPad holder or headphones hanger extend the functionality of mic stands.

# MISCELLANEOUS STANDS

aluminium cast alloy



adjustable clamping lever



Type Approved  
Safety  
Regular Production  
Surveillance

www.tuv.com  
ID 1419036117

## SCP710B

UNIVERSAL HOOK CLAMP WITH TOGGLE BLACK

- Perfect for lighting or media applications
- Adjustable locking lever - never get blocked while fixing
- 100% metal construction (stainless steel and aluminium cast alloy)
- For round or square tubes as well as flat materials
- Clamp range: 13 - 55 mm
- 5/8" (16 mm) hexagon socket
- 1 x 1/4" thread and 2 x M5 thread
- TÜV certified
- Safe work load: 20 kg
- Rustproof
- Optional joining studs available

# MISCELLANEOUS STANDS



## STRS6U

### RACK STAND 6 U

- Rack stand 6 units high
- Black finish, drilled and tapped for M5 screws
- 12 screws included

#### SPECIFICATIONS

Product type	19" Rack stand
Material	steel
Surface	powder coated
Colour	black
Rack bar type	with M5 threaded holes
Height	6 U
Width	530 mm
Height	310 mm
Depth	355 mm



## STRS12U

### RACK STAND 12 U

- Rack stand 12 units high
- Black finish, drilled and tapped for M5 screws
- 24 screws included

#### SPECIFICATIONS

Product type	19" Rack stand
Material	steel
Surface	powder coated
Colour	black
Rack bar type	with M5 threaded holes
Height	12 U
Width	530 mm
Height	525 mm
Depth	355 mm



## DCAM1

### CAMERA ADAPTER 5/8" TO 1/4"

Microphone stand adapter for camera, camcorder, mobile audio recorder or any other compatible gear with a 1/4" thread. Can be mounted on all microphone stands with 5/8" thread. The ball-head allows independent pan and tilt with 360° pan movement and 180° tilt.

- Rubber padded platform to protect your device

#### SPECIFICATIONS

Product type	Camera Adapter
Material	steel
Surface	nickel plated
Thread size 1 (inches)	5/8"
Thread size 2 (inches)	1/4"
Additional information	with universal joint

# MISCELLANEOUS STANDS



## SCS19

### CABLE HOLDER FOR WALL MOUNTING

Universal black cable holder for wall mounting

#### SPECIFICATIONS

Product type	Cable holder
Material	steel, black powder coated
Material thickness	2 mm
Width	318 mm
Height	65 mm
Depth	55 mm



## SDH1

### DRINK HOLDER

Drink Holder for stands with diameter up to 23 mm for bottles, cups or glasses.

#### SPECIFICATIONS

Product type	Holder
Colour	black
Suitable for tube diameter	23 mm
Diameter	90 mm



## SMS14PRO

### PROFESSIONAL MICROPHONE STAND HOLDER FOR IPADS

Professional microphone stand holder for iPad1, iPad2, iPad3 and iPad4 and other tablet PCs with a width of 240 mm to 256 mm and a height of 184 mm to 200 mm with a maximum edge thickness of 10 mm.

- Specially designed for musicians
- Adjustable clamp system with 2 Swivel points
- Horizontal and vertical stand

#### SPECIFICATIONS

Product type	iPad holder
Material	plastic
Colour	black
Mounting	Clamp connector



# MISCELLANEOUS STANDS



## SHPH1

HEADPHONE HOLDER

### SPECIFICATIONS

Product type	Headphone Holder
Colour	black
Clamp dimensions	25 mm
Hanger length	100 mm



A close-up, high-contrast photograph of a speaker cabinet's top hat component. The component is dark, textured, and circular, with a visible mounting hole. The background is black, making the metallic surface stand out.

## **SPEAKER TOP HATS**

Loudspeaker cabinets require pole mount inserts for use with tripod speaker stands. In addition to straight top hats we provide variable tilt and dual tilt versions that enable flexible speaker aiming.

# SPEAKER TOP HATS



## SM700

CABINET FLANGE

### SPECIFICATIONS

Product type	Cabinet Flange
Type	Mounting Flange
Material	steel
Surface	powder coated
Colour	black
Suitable for tube diameter	35 mm
Mounting plate diameter	110 mm
Installed depth / installation height	105 mm
Tiltable	no
With screw clamp	no



## SM701

CABINET FLANGE

### SPECIFICATIONS

Product type	Cabinet Flange
Type	Mounting Flange
Material	steel
Surface	powder coated
Colour	black
Suitable for tube diameter	35 mm
Mounting plate diameter	110 mm
Installed depth / installation height	58 mm
Tiltable	no
With screw clamp	no



## SM702

CABINET FLANGE

### SPECIFICATIONS

Product type	Cabinet Flange
Type	Mounting Flange
Material	die-cast aluminium
Surface	powder coated
Colour	black
Suitable for tube diameter	35 mm
Mounting plate diameter	109 mm
Installed depth / installation height	85 mm
Tiltable	no
With screw clamp	no

# SPEAKER TOP HATS



**SM707**  
CABINET FLANGE

**SPECIFICATIONS**

Product type	Cabinet Flange
Type	Mounting Flange
Material	plastic
Surface	nature
Colour	black
Suitable for tube diameter	35 mm
Mounting plate diameter	164 x 116 mm
Installed depth / installation height	82 mm
Tiltable	yes
With screw clamp	no
Additional information	tiltable $\pm 13.5^\circ$ in $4.5^\circ$ increments



**SM720**  
MOUNTING FLANGE WITH M20 THREAD

**Specifications**

Product type	Cabinet Flange
Type	Mounting Flange
Material	die-cast zinc
Surface	powder coated
Colour	black
Suitable for tube diameter	M20
Mounting plate diameter	105 mm
Installed depth / installation height	26 mm
Tiltable	no
With screw clamp	no
Additional information	with M20 thread for spacer tubes



**SM7DT**  
DUAL-TILT FLANGE ( $0^\circ/5^\circ$ )

**SPECIFICATIONS**

Product type	Cabinet Flange
Type	Mounting Flange
Material	die-cast aluminium
Surface	powder coated
Colour	black
Suitable for tube diameter	35 mm
Mounting plate dimensions	135mm x 90mm
Installed depth / installation height	75 mm
Tiltable	in two increments
With screw clamp	no



**SM707G**  
GASKET FOR SM 707 CABINET FLANGE

**SPECIFICATIONS**

Product type	Seal
Material	Foam rubber
Special feature	self-adhesive

# REGISTER

Article no.	Model name	Description	Page
7114	7114BLK	Microphone Cable 2 x 0.31 mm <sup>2</sup> black	82
7115	7115BLK	Instrument Cable black	85
7116	7116	Microphone Cable	82
7117	7117	High-end instrument cable	85
7118	7118	Microphone Cable	82
7119	7119	Microphone Cable	83
7120	7120	Microphone Cable	83
7121	7121	AES/EBU and DMX Cable 1 10-ohm black	86
7122	7122	110 Ohm AES/EBU and DMX 2-Pair Digital Cable	86
7123	7123	Low Smoke Zero Halogen CAT5e Cable	88
7124	7124	OFC TWIN CABLE	88
7125	7125	OFC TWIN STEREO CABLE	88
7126	7126	OFC TWIN STEREO CABLE	89
7510	7510	6.3 mm Jack Plug mono gold	60
7511	7511	6.3 mm Jack Plug stereo gold	60
7514	7514	6.3 mm Jack Plug mono	60
7515	7515	6.3 mm Jack Plug stereo	60
7516	7516	6.3 mm Jack Plug mono	60
7520	7520	6.3 mm Jack Plug stereo chrome	60
7523	7523	6.3 mm Jack Plug mono with gold Tip	61
7524	7524	6.3 mm Jack Plug stereo with gold Tip	61
7525	7525	Angled 6.3 mm Jack Plug mono flat	61
7540	7540	Adapter mono RCA female to 6.3 mm mono Jack male	72
7541	7541	Adapter 6.3 mm mono Jack female to mono RCA male	75
7542	7542	Adapter 3.5 mm mono Jack female to 6.3 mm mono Jack	73
7543	7543	Adapter 3.5 mm stereo Jack female to 6.3 mm stereo Jack	73
7544	7544	Adapter 6.3 mm stereo Jack female to 3.5 mm stereo Jack	75
7545	7545	Y-Adapter 2 x 3.5 mm stereo Jack female to 6.3 mm stereo	75
7546	7546	Y-Adapter 2 x 6.3 mm stereo Jack female to 6.3 mm stereo	73
7547	7547	Y-Adapter 2 x 6.3 mm mono Jack female to 6.3 mm mono Jack	73
7548	7548	Y-Connector 2 x mono RCA female to 6.3 mm mono Jack male	74
7549	7549	Y-Connector 2 x mono RCA female to 6.3 mm stereo Jack male	74
7550	7550	Y-Connector 2 x mono RCA female to 3.5 mm stereo Jack male	74
7551	7551	Adapter 6.3 mm stereo Jack female to 6.3 mm stereo Jack	73
7552	7552	Adapter 2 x mono RCA female to 2 x mono RCA female	75
7553	7553	Adapter mono RCA male to mono RCA male	75
7554	7554	Adapter 6.3 mm mono Jack female to 3.5 mm mono Jack	74
7555	7555	Adapter 3.5 mm stereo Jack female to 3.5 mm mono Jack	74
7556	7556	Y-Adapter 2 x stereo Jack 3,5 mm female to stereo Jack 3,5 mm male	74
7557	7557	3.5 mm Jack Plug stereo	61
7624	7624	3.5 mm stereo Jack Plug	62
7625	7625	3.5 mm stereo Jack Plug	62
7837	7837	Chassis Connector XLR female D-type	66
7838	7838	Chassis Connector XLR male D-type	66
7847	7847	XLR Plug female	64
7848	7848	XLR Plug male	64
7849	7849	XLR Plug female black	64
7850	7850	XLR Plug male black	64
7853	7853	Adapter 6.3 mm Jack stereo female to XLR male	69
7854	7854	Adapter 6.3 mm Jack stereo female to XLR female	69
7855	7855	Adapter 6.3 mm Jack stereo male to XLR male	70
7856	7856	Adapter 6.3 mm Jack stereo male to XLR female	70
7857	7857	Adapter RCA female to XLR male	71
7858	7858	Adapter RCA female to XLR female	71
7860	7860	Adapter XLR female to XLR female	69
7861	7861	Adapter XLR male to XLR male	69
7863	7863	Adapter Standard Speaker Connector chassis 4-pole to XLR female	71
7864	7864	Adapter Speakon compatible 4-pole chassis to XLR male	71
7865	7865	Adapter Standard Speaker Connector 4-pole to XLR female	72
7866	7866	Adapter Standard Speaker Connector 4-pole to XLR male	72
7867	7867	Adapter XLR male to RCA male	70
7868	7868	Adapter XLR female to RCA male	70
7869	7869	Adapter 3-pole XLR female to 5-pole XLR male	69
7870	7870	Adapter 3-pole XLR male to 5-pole XLR female	69
7871	7871	Standard Speaker Connector 4-pole	67
7872	7872	Adapter XLR male to Jack mono male	70
7873	7873	Adapter XLR female to Jack mono male	70
7874	7874	Standard Speaker Connector 4-pole	67
7875	7875	Standard Speaker Connector Chassis 4-pole	67
7876	7876	Standard Speaker Connector chassis 4-pole	67
7879	7879	Adapter 6.3 mm stereo jack female to 6.3 mm stereo jack female with latch lock	71
7880	7880	Adapter Standard Speaker Connector chassis 4-pole to Standard Speaker Connector chassis 4-pole	71
7882	7882	Adapter 6.3 mm mono Jack male to 6.3 mm mono Jack male, offset	72
7883	7883	Adapter 6.3 mm mono Jack male to 6.3 mm mono Jack male, straight	72
7884	7884	Standard Speaker Connector 4-pole	67
7885	7885	XLR plug female 5-Pol black	65
7886	7886	XLR plug male 5-Pol black	64
7887	7887	RJ45 CAT.5e male	63
7888	7888	XLR Cable Connector 3-Pin Male IP65	65
7889	7889	XLR Cable Connector 3-Pole Female IP65	65
7890	7890	XLR Cable Connector 5-Pole Female IP65	65



# REGISTER

Article no.	Model name	Description	Page
7891	7891	XLR Cable Connector 5-Pin Male IP65	65
7892	7892	Chassis Connector XLR 5-PIN female D-type	66
7893	7893	Chassis Connector XLR 5-PIN male D-type	66
7894	7894	Adapter angled 6.3 mm stereo jack	73
7896	7896	6,3 mm stereo jack plug female	61
7897	7897	XLR RJ45 Shell male	63
7898	7898	XLR PLUG FEMALE SILVER	64
7899	7899	XLR PLUG MALE SILVER	64
70220	70220	Cable Drum small plastic	106
70224	70224	Rugged, lightweight professional cable drum	100
70225	70225	Rugged, lightweight professional cable drum	102
70226	70226	Rugged, lightweight professional cable drum	104
70230	70230	Cable Drum identical to K28C30D	106
70250	70250	Cable Drum black	106
70260	70260	Cable Drum black	107
75192	75192	Angled 6.3 mm Jack Plug mono	61
70224D1	70224 D 1	Front panel for cable drum 70224 with 1 x D-type hole	101
70224D2	70224 D 2	Front panel for cable drum 70224 with 2 x D-type hole	101
70225D1	70225 D 1	Front panel for cable drum 70225 with 1 x D-type hole	103
70225D1	70225 D 1	Front panel for cable drum 70225 with 1 x D-type hole	105
70225D12	70225 D 12	Front panel for cable drum 70225 with 12 x D-type hole	103
70225D12	70225 D 12	Front panel for cable drum 70225 with 12 x D-type hole	105
70225D2	70225 D 2	Front panel for cable drum 70225 with 2 x D-type holes	103
70225D2	70225 D 2	Front panel for cable drum 70225 with 2 x D-type holes	105
70225D4	70225 D 4	Front panel for cable drum 70225 with 4 x D-type hole	103
70225D4	70225 D 4	Front panel for cable drum 70225 with 4 x D-type hole	105
70225D8	70225 D 8	Front panel for cable drum 70225 with 8 x D-type hole	103
70225D8	70225 D 8	Front panel for cable drum 70225 with 8 x D-type hole	105
70226D16	70226 D 16	Front panel for cable drum 70226 with 16 x D-type hole	105
70226D20	70226 D 20	Front panel for cable drum 70226 with 20 x D-type hole	105
70226D24	70226 D 24	Front panel for cable drum 70226 with 24 x D-type hole	105
7543G	7543 G	Adapter 3.5 mm stereo Jack female to 6.3 mm stereo Jack male gold plated	72
7620BLK	7620 BLK	RCA Plug black	62
7620RED	7620 RED	RCA Plug red	62
7622BLK	7622 BLK	RCA Plug black	62
7622RED	7622 RED	RCA Plug red	62
7623BLK	7623 BLK	RCA Plug gold-plated black	63
7623RED	7623 RED	RCA Plug gold-plated red	63
7635BLK	7635 BLK	RCA Socket gold-plated black	63
7635RED	7635 RED	RCA Socket gold-plated red	63
8101KA0050	8101 KA 0050	Power Cord CEE 7/7 - C13 0.5 m	124
8101KA0100	8101 KA 0100	Power Cord CEE 7/7 - C13 1 m	124
8101KA0200	8101 KA 0200	Power Cord CEE 7/7 - C13 2 m	124
8101KA0300	8101 KA 0300	Power Cord CEE 7/7 - C13 3 m	124
8101KA0500	8101 KA 0500	Power Cord CEE 7/7 - C13 5 m	124
8101KB0200GB	8101 KB 0200 GB	Power Cord BS1363/A (UK) - C13 2 m	124
8101KB0300GB	8101 KB 0300 GB	Power Cord BS1363/A (UK) - C13 3 m	124
8101KB1000	8101 KB 1000	Power Cord CEE 7/7 - C13 10 m	124
8101KC0050	8101 KC 0050	Extension Cable C13 - C14 0.5 m	125
8101KC0100	8101 KC 0100	Extension Cable C13 - C14 1 m	125
8101KC0300	8101 KC 0300	Extension Cable C13 - C14 3 m	125
8101KC0500	8101 KC 0500	Extension Cable C13 - C14 5 m	125
8101KD0100	8101 KD 0100	Extension Cable C13 - C14 1 m	125
8101KD0300	8101 KD 0300	Extension Cable C13 - C14 3 m	125
8101KD0500	8101 KD 0500	Extension Cable C13 - C14 5 m	125
8101KF0150	8101 KF 0150	Extension Cable CEE 7/7 IP44 - CEE 7 IP44 1.5 m	125
8101KF0300	8101 KF 0300	Extension Cable CEE 7/7 IP44 - CEE 7 IP44 3 m	125
8101KF0500	8101 KF 0500	Extension Cable CEE 7/7 IP44 - CEE 7 IP44 5 m	125
8101KF1000	8101 KF 1000	Extension Cable CEE 7/7 IP44 - CEE 7 IP44 10 m	125
8101KF1500	8101 KF 1500	Extension Cable CEE 7/7 IP44 - CEE 7 IP44 15 m	125
8101KF2000	8101 KF 2000	Extension Cable CEE 7/7 IP44 - CEE 7 IP44 20 m	125
8101KG0300	8101 KG 0300	Extension Cable CEE 7/7 IP44 - CEE 7 IP44 3 m	126
8101KG0500	8101 KG 0500	Extension Cable CEE 7/7 IP44 - CEE 7 IP44 5 m	126
8101KG1000	8101 KG 1000	Extension Cable CEE 7/7 IP44 - CEE 7 IP44 10 m	126
8101KG1500	8101 KG 1500	Extension Cable CEE 7/7 IP44 - CEE 7 IP44 15 m	126
8101KG2000	8101 KG 2000	Extension Cable CEE 7/7 IP44 - CEE 7 IP44 20 m	126
8101KI0050	8101 KI 0050	Power Adapter Cable CEE 7 IP44 - C14 0.5 m	126
8101KI0100	8101 KI 0100	Power Adapter Cable CEE 7 IP44 - C14 1 m	126
8101KP0135GB	8101 KP 0135 GB	PowerCon to UK Cable 1,35m	130
8101P	8101 P	IECC Power Plug female	67
8101PCONL	8101 PCONL 0150	powerCON Link Cable 1,5m	130
8101S	8101 S	IECC Power Socket male	68
8101TCONL	8101 TCONL 0150	PowerCON TRUE1 Link Cable IP65 1,5m	130
8102C	8102 C	IECC Power Plug male	68
CBSCREWSET	CBSCREWSET	T-Bar Nut and Bolt Set	173
D800	D 800	Adapter 5/8" to 3/8"	163
D801	D 801	Adapter 3/8" to 5/8"	163
D902	D 902	Microphone Holder for Wireless Microphones	163
D903	D 903	Microphone Holder	163
D905	D 905	Microphone Holder for Wireless Microphones	163
D906	D 906	Microphone Holder	164

# REGISTER

Article no.	Model name	Description	Page
D907	D 907	Microphone Holder for Wireless Microphones	164
D910	D 910	Pop Filter	164
D914	D 914	Pop Filter	164
D921	D 921	Gooseneck Mounting Plate	164
D921BLK	D 921 BLK	Gooseneck Mounting Plate	164
DCAM1	DCAM 1	Camera Adapter 5/8" to 1/4"	207
DSM400	DSM 400	Microphone Shock Mount with Pop Filter	164
DSM40B	DSM 40 B	Microphone Shock Mount 40 - 44 mm black	165
DSM45B	DSM 45 B	Microphone Shock Mount 45 - 49 mm black	165
K12C10	K 12 C 10	Multicore with Stage Box 12/0 10 m	110
K20C15	K 20 C 15	Multicore with Stage Box 16/4 15 m	110
K20C30	K 20 C 30	Multicore with Stage Box 16/4 30 m	111
K20C30D	K 20 C 30 D	Multicore on Drum with Stage Box 16/4 30 m	111
K20C50	K 20 C 50	Multicore with Stage Box 16/4 50 m	112
K20C50D	K 20 C 50 D	Multicore on Drum with Stage Box 16/4 50 m	112
K28C30	K 28 C 30	Multicore with Stage Box 24/4 30 m	113
K28C30D	K 28 C 30 D	Multicore on Drum with Stage Box 24/4 30 m	113
K28C50	K 28 C 50	Multicore with Stage Box 24/4 50 m	114
K28C50D	K 28 C 50 D	Multicore on Drum with Stage Box 24/4 50 m	114
K32C30	K 32 C 30	Multicore with Stage Box 24/8 30 m	115
K32C30D	K 32 C 30 D	Multicore on Drum with Stage Box 24/8 30 m	115
K32C50	K 32 C 50	Multicore with Stage Box 24/8 50 m	116
K32C50D	K 32 C 50 D	Multicore on Drum with Stage Box 24/8 50 m	116
K3BFV0100	K3 BFV 0100	Microphone Cable XLR female to 6.3 mm Jack stereo 1 m	43
K3BFV0300	K3 BFV 0300	Microphone Cable XLR female to 6.3 mm Jack stereo 3 m	43
K3BFV0600	K3 BFV 0600	Microphone Cable XLR female to 6.3 mm Jack stereo 6 m	43
K3BFV1000	K3 BFV 1000	Microphone Cable XLR female to 6.3 mm Jack stereo 10 m	43
K3BMV0100	K3 BMV 0100	Microphone Cable XLR male to 6.3 mm Jack stereo 1 m	43
K3BMV0300	K3 BMV 0300	Microphone Cable XLR male to 6.3 mm Jack stereo 3 m	43
K3BMV0600	K3 BMV 0600	Microphone Cable XLR male to 6.3 mm Jack stereo 6 m	43
K3BMV1000	K3 BMV 1000	Microphone Cable XLR male to 6.3 mm Jack stereo 10 m	43
K3BVV0030ECO	K3 BVV 0030 ECO	Patch Cable 6.3 mm Jack stereo to 6.3 mm Jack stereo 0.3 m	44
K3BVV0030SET	K3 BVV 0030 SET	Patch Cable Set of 6 cables 6.3 mm Jack stereo to 6.3 mm Jack stereo 0.3 m	44
K3BVV0060	K3 BVV 0060	Audio Cable 6.3 mm Jack stereo to 6.3 mm Jack stereo 0.6 m	44
K3BVV0060ECO	K3 BVV 0060 ECO	Patch Cable 6.3 mm Jack stereo to 6.3 mm Jack stereo 0.6 m	44
K3BVV0060SET	K3 BVV 0060 SET	Patch Cable Set of 6 cables 6.3 mm Jack stereo to 6.3 mm Jack stereo 0.6 m	44
K3BVV0090	K3 BVV 0090	Audio Cable 6.3 mm Jack stereo to 6.3 mm Jack stereo 0.9 m	44
K3BVV0090ECO	K3 BVV 0090 ECO	Patch Cable 6.3 mm Jack stereo to 6.3 mm Jack stereo 0.9 m	44
K3BVV0090SET	K3 BVV 0090 SET	Patch Cable Set of 6 cables 6.3 mm Jack stereo to 6.3 mm Jack stereo 0.9 m	44
K3BVV0120SET	K3 BVV 0120 SET	Patch Cable Set 6.3 mm Jack stereo to 6.3 mm Jack stereo 1.2 m	44
K3BVV0150	K3 BVV 0150	Audio Cable 6.3 mm Jack stereo to 6.3 mm Jack stereo 1.5 m	44
K3BVV0300	K3 BVV 0300	Audio Cable 6.3 mm Jack stereo to 6.3 mm Jack stereo 3 m	44
K3BVV0600	K3 BVV 0600	Audio Cable 6.3 mm Jack stereo to 6.3 mm Jack stereo 6 m	44
K3BVV0900	K3 BVV 0900	Audio Cable 6.3 mm Jack stereo to 6.3 mm Jack stereo 9 m	44
K3CDCAT5030	K 3 CDCAT 5030	Cable Drum with CAT 5 Ethernet Cable 30 m	56
K3CDDMX3030	K 3 CDDMX 3030	Cable Drum 3-pin DMX/AES 30 m	54
K3CDDMX5030	K 3 CDDMX 5030	Cable Drum 5-pin DMX/AES 30 m	54
K3CDMC6215	K 3 CDMC 6215	3-Star 15 m 6/2-Channel Audio Snake Reel	55
K3CDMC6215	K 3 CDMC 6215	3-Star 15 m 6/2-Channel Audio Snake Reel	121
K3CDMC8015	K 3 CDMC 8015	3-Star 15 m 8/0-Channel Audio Snake Reel	55
K3CDMC8015	K 3 CDMC 8015	3-Star 15 m 8/0-Channel Audio Snake Reel	121
K3DGF0020	K3 DGF 0020	DMX Adapter XLR male 5-pin to XLR female 3-pin 0.2 m	48
K3DGH0050	K3 DGH 0050	DMX Cable XLR male 5-pin to XLR female 5-pin 0.5 m	47
K3DGH0150	K3 DGH 0150	DMX Cable XLR male 5-pin to XLR female 5-pin 1.5 m	47
K3DGH0300	K3 DGH 0300	DMX Cable XLR male 5-pin to XLR female 5-pin 3 m	47
K3DGH0600	K3 DGH 0600	DMX Cable XLR male 5-pin to XLR female 5-pin 6 m	47
K3DGH1000	K3 DGH 1000	DMX Cable XLR male 5-pin to XLR female 5-pin 10 m	47
K3DGH1500	K3 DGH 1500	DMX Cable XLR male 5-pin to XLR female 5-pin 15 m	47
K3DGH2000	K3 DGH 2000	DMX Cable XLR male 5-pin to XLR female 5-pin 20 m	47
K3DGH3000	K3 DGH 3000	DMX Cable XLR male 5-pin to XLR female 5-pin 30 m	47
K3DHM0020	K3 DHM 0020	DMX Adapter XLR female 5-pin to XLR female 3-pin 0.2 m	48
K3DMF0050	K3 DMF 0050	DMX Cable XLR male to XLR female 0.5 m	47
K3DMF0150	K3 DMF 0150	DMX Cable XLR male to XLR female 1.5 m	47
K3DMF0300	K3 DMF 0300	DMX Cable XLR male to XLR female 3 m	47
K3DMF0600	K3 DMF 0600	DMX Cable XLR male to XLR female 6 m	47
K3DMF1000	K3 DMF 1000	DMX Cable XLR male to XLR female 10 m	47
K3DMF1500	K3 DMF 1500	DMX Cable XLR male to XLR female 15 m	47
K3DMF2000	K3 DMF 2000	DMX Cable XLR male to XLR female 20 m	47
K3DMF3000	K3 DMF 3000	DMX Cable XLR male to XLR female 30 m	47
K3DMXAES	K3 DMXAES	AES/EBU and DMX Cable 110-ohm digital black	86
K3DMXT3	K3 DMXT 3	DMX Terminator 3-pole 120 Ohms	66
K3DMXT5	K3 DMXT 5	DMX Terminator 5-pole 120 Ohms	66
K3DTOS2M0050	K3 DTOS 2M 0050	Audio Cable Toslink to Toslink 2.2 mm Ø 0.5 m	51
K3DTOS2M0100	K3 DTOS 2M 0100	Audio Cable Toslink to Toslink 2.2 mm Ø 1.0 m	51
K3DTOS2M0200	K3 DTOS 2M 0200	Audio Cable Toslink to Toslink 2.2 mm Ø 2.0 m	51
K3DTOS2M0500	K3 DTOS 2M 0500	Audio Cable Toslink to Toslink 2.2 mm Ø 5.0 m	51
K3DTOS2M1000	K3 DTOS 2M 1000	Audio Cable Toslink to Toslink 2.2 mm Ø 10.0 m	51
K3DTOS4M0050	K3 DTOS 4M 0050	Audio Cable Toslink to Toslink 4 mm Ø 0.5 m	51
K3DTOS4M0100	K3 DTOS 4M 0100	Audio Cable Toslink to Toslink 4 mm Ø 1.0 m	51
K3DTOS4M0200	K3 DTOS 4M 0200	Audio Cable Toslink to Toslink 4 mm Ø 2.0 m	51
K3DTOS4M0500	K3 DTOS 4M 0500	Audio Cable Toslink to Toslink 4 mm Ø 5.0 m	51



# REGISTER

Article no.	Model name	Description	Page
K3DTOS4M1000	K3 DTOS 4M 1000	Audio Cable Toslink to Toslink 4 mm Ø 10,0 m	51
K3IPP0300	K3 IPP 0300	Instrument Cable 6.3 mm Jack mono to 6.3 mm Jack mono 3 m	40
K3IPP0300P	K3 IPP 0300P	Instrument Cable 6.3 mm Jack mono to 6.3 mm Jack mono 3 m	41
K3IPP0300S	K3 IPP 0300 S	Instrument Cable 6.3 mm Jack mono to 6.3 mm Jack mono 3 m	41
K3IPP0300V	K3 IPP 0300 V	Vintage Instrument Cable 6.3 mm Jack mono to 6.3 mm Jack mono 3 m	41
K3IPP0600	K3 IPP 0600	Instrument Cable 6.3 mm Jack mono to 6.3 mm Jack mono 6 m	40
K3IPP0600P	K3 IPP 0600 P	Instrument Cable 6.3 mm Jack mono to 6.3 mm Jack mono 6 m	41
K3IPP0600S	K3 IPP 0600 S	Instrument Cable 6.3 mm Jack mono to 6.3 mm Jack mono 6 m	41
K3IPP0600V	K3 IPP0 600 V	Vintage Instrument Cable 6.3 mm Jack mono to 6.3 mm Jack mono 6 m	41
K3IPP0900	K3 IPP 0900	Instrument Cable 6.3 mm Jack mono to 6.3 mm Jack mono 9 m	40
K3IPP0900P	K3 IPP 0900 P	Instrument Cable 6.3 mm Jack mono to 6.3 mm Jack mono 9 m	41
K3IPP0900S	K3 IPP 0900 S	Instrument Cable 6.3 mm Jack mono to 6.3 mm Jack mono 9 m	41
K3IPP0900V	K3 IPP 0900 V	Vintage Instrument Cable 6.3 mm Jack mono to 6.3 mm Jack mono 9 m	41
K3IPR0300	K3 IPR 0300	Instrument Cable 6.3 mm Jack mono to 6.3 mm angled Jack mono 3 m	40
K3IPR0300P	K3 IPR 0300 P	Instrument Cable 6.3 mm Jack mono to 6.3 mm angled Jack mono 3 m	41
K3IPR0600	K3 IPR 0600	Instrument Cable 6.3 mm Jack mono to 6.3 mm angled Jack mono 6 m	40
K3IPR0600P	K3 IPR 0600 P	Instrument Cable 6.3 mm Jack mono to 6.3 mm angled Jack mono 6 m	41
K3IPR0900	K3 IPR 0900	Instrument Cable 6.3 mm Jack mono to 6.3 mm angled Jack mono 9 m	40
K3IPR0900P	K3 IPR 0900 P	Instrument Cable 6.3 mm Jack mono to 6.3 mm angled Jack mono 9 m	41
K3IRR0015	K3 IRR 0015	Instrument Cable 6.3 mm angled Jack mono to 6.3 mm angled Jack mono 0.15 m	41
K3IRR0030	K3 IRR 0030	Instrument Cable 6.3 mm angled Jack mono to 6.3 mm angled Jack mono 0.3 m	41
K3IRR0060	K3 IRR 0060	Instrument Cable 6.3 mm angled Jack mono to 6.3 mm angled Jack mono 0.6 m	41
K3L8CC0300	K3 L8 CC 0300	Multicore Cable 8 x RCA male to 8 x RCA male 3 m	52
K3L8CC0500	K3 L8 CC 0500	Multicore Cable 8 x RCA male to 8 x RCA male 5 m	52
K3L8FV0300	K3 L8 FV 0300	Multicore cable 8 x XLR female to 8 x 6.3 mm Jack stereo 3 m	52
K3L8FV0500	K3 L8 FV 0500	Multicore cable 8 x XLR female to 8 x 6.3 mm Jack stereo 5 m	52
K3L8MF0300	K3 L8 MF 0300	Multicore Cable 8 x XLR male to 8 x XLR female 3 m	52
K3L8MF0500	K3 L8 MF 0500	Multicore Cable 8 x XLR male to 8 x XLR female 5 m	52
K3L8MV0300	K3 L8 MV 0300	Multicore Cable 8 x XLR male to 8 x 6.3 mm Jack stereo 3 m	53
K3L8MV0500	K3 L8 MV 0500	Multicore Cable 8 x XLR male to 8 x 6.3 mm Jack stereo 5 m	53
K3L8PC0300	K3 L8 PC 0300	Multicore Cable 8 x 6.3 mm Jack mono to 8 x RCA male 3 m	53
K3L8PC0500	K3 L8 PC 0500	Multicore Cable 8 x 6.3 mm Jack mono to 8 x RCA male 5 m	53
K3L8PP0300	K3 L8 PP 0300	Multicore Cable 8 x 6.3 mm Jack mono to 8 x 6.3 mm Jack mono 3 m	53
K3L8PP0500	K3 L8 PP 0500	Multicore Cable 8 x 6.3 mm Jack mono to 8 x 6.3 mm Jack mono 5 m	53
K3L8VP0300	K3 L8 VP0 300	Multicore Cable 4 x 6.3 mm Jack stereo to 8 x 6.3 mm Jack mono 3 m	53
K3L8VP0500	K3 L8 VP 0500	Multicore Cable 4 x 6.3 mm Jack stereo to 8 x 6.3 mm Jack mono 5 m	53
K3L8VV0300	K3 L8 VV 0300	Multicore Cable 8 x 6.3 mm Jack stereo to 8 x 6.3 mm Jack stereo 3 m	53
K3L8VV0500	K3 L8 VV 0500	Multicore Cable 8 x 6.3 mm Jack stereo to 8 x 6.3 mm Jack stereo 5 m	53
K3MFP0100	K3 MFP 0100	Microphone Cable XLR female to 6.3 mm Jack mono 1 m	42
K3MFP0300	K3 MFP 0300	Microphone Cable XLR female to 6.3 mm Jack mono 3 m	42
K3MFP0600	K3 MFP 0600	Microphone Cable XLR female to 6.3 mm Jack mono 6 m	42
K3MFP1000	K3 MFP 1000	Microphone Cable XLR female to 6.3 mm Jack mono 10 m	42
K3MIDI0075BLK	K3 MIDI 0075 BLK	MIDI Cable 0.75 m black	50
K3MIDI0075BLU	K3 MIDI 0075 BLU	MIDI Cable 0.75 m blue	50
K3MIDI0075GRN	K3 MIDI 0075 GRN	MIDI Cable 0.75 m green	50
K3MIDI0075RED	K3 MIDI 0075 RED	MIDI Cable 0.75 m red	50
K3MIDI0150BLK	K3 MIDI 0150 BLK	MIDI Cable 1.5 m black	50
K3MIDI0150BLU	K3 MIDI 0150 BLU	MIDI Cable 1.5 m blue	50
K3MIDI0150GRN	K3 MIDI 0150 GRN	MIDI Cable 1.5 m green	50
K3MIDI0150RED	K3 MIDI 0150 RED	MIDI Cable 1.5 m red	50
K3MIDI0300BLK	K3 MIDI 0300 BLK	MIDI Cable 3 m black	50
K3MIDI0300BLK-5	K3 MIDI 0300 BLK-5	MIDI Kabel 3 m black 5-pole	50
K3MIDI0300BLU	K3 MIDI 0300 BLU	MIDI Cable 3 m blue	50
K3MIDI0300GRN	K3 MIDI 0300 GRN	MIDI Cable 3 m green	50
K3MIDI0600BLK	K3 MIDI 0600 BLK	MIDI Cable 6 m black	50
K3MIDI0600BLK-5	K3 MIDI 0600 BLK-5	MIDI Kabel 6 m black 5-pole	50
K3MIDI0600BLU	K3 MIDI 0600 BLU	MIDI Cable 6 m blue	50
K3MIDI0600GRN	K3 MIDI 0600 GRN	MIDI Cable 6 m green	50
K3MIDI0600RED	K3 MIDI 0600 RED	MIDI Cable 6 m red	50
K3MMF0050	K3 MMF 0050	Microphone Cable XLR female to XLR male 0.5 m	42
K3MMF0100	K3 MMF 0100	Microphone Cable XLR female to XLR male 1 m	42
K3MMF0300	K3 MMF 0300	Microphone Cable XLR female to XLR male 3 m	42
K3MMF0600	K3 MMF 0600	Microphone Cable XLR female to XLR male 6 m	42
K3MMF1000	K3 MMF 1000	Microphone Cable XLR female to XLR male 10 m	42
K3MMF1500	K3 MMF 1500	Microphone Cable XLR female to XLR male 15 m	42
K3MMF2000	K3 MMF 2000	Microphone Cable XLR female to XLR male 20 m	42
K3MMF3000	K3 MMF 3000	Microphone Cable XLR female to XLR male 30 m	42
K3MMP0100	K3 MMP 0100	Microphone Cable XLR male to 6.3 mm Jack mono 1 m	42
K3MMP0300	K3 MMP 0300	Microphone Cable XLR male to 6.3 mm Jack mono 3 m	42
K3MMP0600	K3 MMP 0600	Microphone Cable XLR male to 6.3 mm Jack mono 6 m	42
K3MMP1000	K3 MMP 1000	Microphone Cable XLR male to 6.3 mm Jack mono 10 m	42
K3S215PP0150	K3 S215 PP 0150	Speaker Cable 2 x 1.5 mm <sup>2</sup> 6.3 mm Jack mono to 6.3 mm Jack mono 1.5 m	49
K3S215PP0300	K3 S215 PP 0300	Speaker Cable 2 x 1.5 mm <sup>2</sup> 6.3 mm Jack mono to 6.3 mm Jack mono 3 m	49
K3S215PP0500	K3 S215 PP 0500	Speaker Cable 2 x 1.5 mm <sup>2</sup> 6.3 mm Jack mono to 6.3 mm Jack mono 5 m	49
K3S215PP1000	K3 S215 PP 1000	Speaker Cable 2 x 1.5 mm <sup>2</sup> 6.3 mm Jack mono to 6.3 mm Jack mono 10 m	49
K3S215SS0200	K3 S215 SS 0200	Speaker Cable 2 x 1.5 mm <sup>2</sup> Standard Speaker Connector 4-pole to Standard Speaker Connector 4-pole 2 m	49
K3S215SS0500	K3 S215 SS 0500	Speaker Cable 2 x 1.5 mm <sup>2</sup> Standard Speaker Connector 4-pole to Standard Speaker Connector 4-pole 5 m	49
K3S215SS1000	K3 S215 SS 1000	Speaker Cable 2 x 1.5 mm <sup>2</sup> Standard Speaker Connector 4-pole to Standard Speaker Connector 4-pole 10 m	49
K3S225SS0200	K3 S225 SS 0200	Speaker Cable 2 x 2.5 mm <sup>2</sup> Standard Speaker Connector 4-pole to Standard Speaker Connector 4-pole 2 m	49
K3S225SS0500	K3 S225 SS 0500	Speaker Cable 2 x 2.5 mm <sup>2</sup> Standard Speaker Connector 4-pole to Standard Speaker Connector 4-pole 5 m	49
K3S225SS1000	K3 S225 SS 1000	Speaker Cable 2 x 2.5 mm <sup>2</sup> Standard Speaker Connector 4-pole to Standard Speaker Connector 4-pole 10 m	49

# REGISTER

Article no.	Model name	Description	Page
K3S225S51500	K3 S225 S5 1500	Speaker Cable 2 x 2.5 mm <sup>2</sup> Standard Speaker Connector 4-pole to Standard Speaker Connector 4-pole 15 m	49
K3S225S52000	K3 S225 S5 2000	Speaker Cable 2 x 2.5 mm <sup>2</sup> Standard Speaker Connector 4-pole to Standard Speaker Connector 4-pole 20 m	49
K3TCC0100	K3 TCC 0100	Audio Cable 2 x RCA male to 2 x RCA male 1 m	45
K3TCC0300	K3 TCC 0300	Audio Cable 2 x RCA male to 2 x RCA male 3 m	45
K3TCC0600	K3 TCC 0600	Audio Cable 2 x RCA male to 2 x RCA male 6 m	45
K3TPC0100	K3 TPC 0100	Audio Cable 2 x RCA male to 2 x 6.3 mm Jack mono 1 m	45
K3TPC0300	K3 TPC 0300	Audio Cable 2 x RCA male to 2 x 6.3 mm Jack mono 3 m	45
K3TPC0600	K3 TPC 0600	Audio Cable 2 x RCA male to 2 x 6.3 mm Jack mono 6 m	45
K3TPP0100	K3 TPP 0100	Audio Cable 2 x 6.3 mm Jack mono to 2 x 6.3 mm Jack mono 1 m	45
K3TPP0300	K3 TPP 0300	Audio Cable 2 x 6.3 mm Jack mono to 2 x 6.3 mm Jack mono 3 m	45
K3TPP0600	K3 TPP 0600	Audio Cable 2 x 6.3 mm Jack mono to 2 x 6.3 mm Jack mono 6 m	45
K3YVPP0100	K3 YVPP 0100	Audio Cable 6.3 mm Jack stereo to 2 x 6.3 mm Jack mono 1 m	46
K3YVPP0300	K3 YVPP 0300	Audio Cable 6.3 mm Jack stereo to 2 x 6.3 mm Jack mono 3 m	46
K3YVPP0600	K3 YVPP 0600	Audio Cable 6.3 mm Jack stereo to 2 x 6.3 mm Jack mono 6 m	46
K3YWCC0100	K3 YWCC 0100	Audio Cable 3.5 mm Jack stereo to 2 x RCA male 1 m	46
K3YWCC0300	K3 YWCC 0300	Audio Cable 3.5 mm Jack stereo to 2 x RCA male 3 m	46
K3YWCC0600	K3 YWCC 0600	Audio Cable 3.5 mm Jack stereo to 2 x RCA male 6 m	46
K3YWPP0100	K3 YWPP 0100	Audio Cable 3.5 mm Jack stereo to 2 x 6.3 mm Jack mono 1 m	46
K3YWPP0300	K3 YWPP 0300	Audio Cable 3.5 mm Jack stereo to 2 x 6.3 mm Jack mono 3 m	46
K3YWPP0600	K3 YWPP 0600	Audio Cable 3.5 mm Jack stereo to 2 x 6.3 mm Jack mono 6 m	46
K40C30	K 40 C 30	Multicore with Stage Box 32/8 30 m	117
K40C30	K 40 C 30	Multicore with Stage Box 32/8 30 m	119
K40C50	K 40 C 50	Multicore with Stage Box 32/8 50 m	117
K40C50	K 40 C 50	Multicore with Stage Box 32/8 50 m	119
K40C50D	K 40 C 50 D	Multicore on Drum with Stage Box 32/8 50 m	118
K40C50D	K 40 C 50 D	Multicore on Drum with Stage Box 32/8 50 m	120
K4BFV0030	K4 BFV 0030	Microphone Cable REAN XLR female to 6.3 mm Jack stereo 0.3 m	28
K4BFV0060	K4 BFV 0060	Microphone Cable REAN XLR female to 6.3 mm Jack stereo 0.6 m	28
K4BFV0150	K4 BFV 0150	Microphone Cable REAN XLR female to 6.3 mm Jack stereo 1.5 m	28
K4BFV0300	K4 BFV 0300	Microphone Cable REAN XLR female to 6.3 mm Jack stereo 3 m	28
K4BFV0500	K4 BFV 0500	Microphone Cable REAN XLR female to 6.3 mm Jack stereo 5 m	28
K4BFV0600	K4 BFV 0600	Microphone Cable REAN XLR female to 6.3 mm Jack stereo 6 m	28
K4BFV0750	K4 BFV 0750	Microphone Cable REAN XLR female to 6.3 mm Jack stereo 7.5 m	28
K4BFV1000	K4 BFV 1000	Microphone Cable REAN XLR female to 6.3 mm Jack stereo 10 m	28
K4BMV0030	K4 BMV 0030	Microphone Cable REAN XLR male to 6.3 mm Jack stereo 0.3 m	28
K4BMV0060	K4 BMV 0060	Microphone Cable REAN XLR male to 6.3 mm Jack stereo 0.6 m	28
K4BMV0150	K4 BMV 0150	Microphone Cable REAN XLR male to 6.3 mm Jack stereo 1.5 m	28
K4BMV0300	K4 BMV 0300	Microphone Cable REAN XLR male to 6.3 mm Jack stereo 3 m	28
K4BMV0500	K4 BMV 0500	Microphone Cable REAN XLR male to 6.3 mm Jack stereo 5 m	28
K4BMV0600	K4 BMV 0600	Microphone Cable REAN XLR male to 6.3 mm Jack stereo 6 m	28
K4BMV0750	K4 BMV 0750	Microphone Cable REAN XLR male to 6.3 mm Jack stereo 7.5 m	28
K4BMV1000	K4 BMV 1000	Microphone Cable REAN XLR male to 6.3 mm Jack stereo 10 m	28
K4BOV0300	K4 BOV 0300	Headphone Extension 6.3 mm Jack stereo to 6.3 mm Jack stereo 3 m	29
K4BOV0600	K4 BOV 0600	Headphone Extension 6.3 mm Jack stereo to 6.3 mm Jack stereo 6 m	29
K4BVV0060	K4 BVV 0060	Patch Cable REAN 6.3 mm Jack stereo to 6.3 mm Jack stereo 0.6 m	28
K4BVV0090	K4 BVV 0090	Patch Cable REAN 6.3 mm Jack stereo to 6.3 mm Jack stereo 0.9 m	28
K4BVV0150	K4 BVV 0150	Patch Cable REAN 6.3 mm Jack stereo to 6.3 mm Jack stereo 1.5 m	28
K4BVV0300	K4 BVV 0300	Patch Cable REAN 6.3 mm Jack stereo to 6.3 mm Jack stereo 3 m	28
K4BVV0600	K4 BVV 0600	Patch Cable REAN 6.3 mm Jack stereo to 6.3 mm Jack stereo 6 m	28
K4BVV0900	K4 BVV 0900	Patch Cable REAN 6.3 mm Jack stereo to 6.3 mm Jack stereo 9 m	28
K4CAT50050	K 4 CAT 50050	Cat5e Cable RJ45 to RJ45 0,5 m	36
K4CAT50100	K 4 CAT5 0100	Cat5e Cable RJ45 to RJ45 1 m	36
K4CAT50100I	K 4 CAT 50100 I	Cat5e Cable RJ45 to RJ45 1 m	37
K4CAT50300	K 4 CAT5 0300	Cat5e Cable RJ45 to RJ45 3 m	36
K4CAT50300I	K 4 CAT 50300 I	Cat5e Cable RJ45 to RJ45 3 m	37
K4CAT50500	K 4 CAT5 0500	Cat5e Cable RJ45 to RJ45 5 m	36
K4CAT50500I	K 4 CAT 50500 I	Cat5e Cable RJ45 to RJ45 5 m	37
K4CAT51000	K 4 CAT5 1000	Cat5e Cable RJ45 to RJ45 10 m	36
K4CAT51000I	K 4 CAT 51000 I	Cat5e Cable RJ45 to RJ45 10 m	37
K4CAT51500	K 4 CAT5 1500	Cat5e Cable RJ45 to RJ45 15 m	36
K4CAT51500I	K 4 CAT 51500 I	Cat5e Cable RJ45 to RJ45 15 m	37
K4CAT52000	K 4 CAT5 2000	Cat5e Cable RJ45 to RJ45 20 m	36
K4CAT52000I	K 4 CAT 52000 I	Cat5e Cable RJ45 to RJ45 20 m	37
K4CAT55000	K 4 CAT5 5000	Cat5e Cable RJ45 to RJ45 50 m	36
K4CAT57000	K 4 CAT5 7000	Cat5e Cable RJ45 to RJ45 70 m	36
K4DGH0050IP65	K 4 DGH 0050 IP 65	DMX AES/EBU Cable 5-pole XLR male to XLR female IP65 0.5 m	34
K4DGH0150IP65	K 4 DGH 0150 IP 65	DMX AES/EBU Cable 5-pole XLR male to XLR female IP65 1.5 m	34
K4DGH0300IP65	K 4 DGH 0300 IP 65	DMX AES/EBU Cable 5-pole XLR male to XLR female IP65 3 m	34
K4DGH0500IP65	K 4 DGH 0500 IP 65	DMX AES/EBU Cable 5-pole XLR male to XLR female IP65 5 m	34
K4DGH1000IP65	K 4 DGH 1000 IP 65	DMX AES/EBU Cable 5-pole XLR male to XLR female IP65 10 m	34
K4DGH1500IP65	K 4 DGH 1500 IP 65	DMX AES/EBU Cable 5-pole XLR male to XLR female IP65 15 m	34
K4DGH2000IP65	K 4 DGH 2000 IP 65	DMX AES/EBU Cable 5-pole XLR male to XLR female IP65 20 m	34
K4DGH3000IP65	K 4 DGH 3000 IP 65 DMX	DMX AES/EBU Cable 5-pole XLR male to XLR female IP65 30 m	34
K4DMF0050	K4 DMF 0050	DMX Cable REAN XLR male to XLR female 0.5 m	33
K4DMF0050IP65	K 4 DMF 0050 IP 65	DMX AES/EBU Cable 3-pol XLR male to XLR female IP65 0.5 m	34
K4DMF0100	K4 DMF 0100	DMX Cable REAN XLR male to XLR female 1 m	33
K4DMF0150IP65	K 4 DMF 0150 IP 65	DMX AES/EBU Cable 3-pol XLR male to XLR female IP65 1.5 m	34
K4DMF0300	K4 DMF 0300	DMX Cable REAN XLR male to XLR female 3 m	33
K4DMF0300IP65	K 4 DMF 0300 IP 65	DMX AES/EBU Cable 3-pol XLR male to XLR female IP65 3 m	34
K4DMF0500	K4 DMF 0500	DMX Cable REAN XLR male to XLR female 5 m	33

# REGISTER

Article no.	Model name	Description	Page
K4DMF0500IP65	K 4 DMF 0500 IP 65	DMX AES/EBU Cable 3-pol XLR male to XLR female IP65 5 m	34
K4DMF1000	K4 DMF 1000	DMX Cable REAN XLR male to XLR female 10 m	33
K4DMF1000IP65	K 4 DMF 1000 IP 65	DMX AES/EBU Cable 3-pol XLR male to XLR female IP65 10 m	34
K4DMF1500	K4 DMF 1500	DMX Cable REAN XLR male to XLR female 15 m	33
K4DMF1500IP65	K 4 DMF 1500 IP 65	DMX AES/EBU Cable 3-pol XLR male to XLR female IP65 15 m	34
K4DMF2000	K4 DMF 2000	DMX Cable REAN XLR male to XLR female 20 m	33
K4DMF2000IP65	K 4 DMF 2000 IP 65	DMX AES/EBU Cable 3-pol XLR male to XLR female IP65 20 m	34
K4DMF3000	K4 DMF 3000	DMX Cable REAN XLR male to XLR female 30 m	33
K4DMF3000IP65	K 4 DMF 3000 IP 65	DMX AES/EBU Cable 3-pol XLR male to XLR female IP65 30 m	34
K4IPP0030	K4 IPP 0030	Instrument Cable REAN 6.3 mm Jack mono to 6.3 mm Jack mono 0.3 m	24
K4IPP0060	K4 IPP 0060	Instrument Cable REAN 6.3 mm Jack mono to 6.3 mm Jack mono 0.6 m	24
K4IPP0090	K4 IPP 0090	Instrument Cable REAN 6.3 mm Jack mono to 6.3 mm Jack mono 0.9 m	24
K4IPP0150	K4 IPP 0150	Instrument Cable REAN 6.3 mm Jack mono to 6.3 mm Jack mono 1.5 m	24
K4IPP0300	K4 IPP 0300	Instrument Cable REAN 6.3 mm Jack mono to 6.3 mm Jack mono 3 m	24
K4IPP0450	K4 IPP 0450	Instrument Cable REAN 6.3 mm Jack mono to 6.3 mm Jack mono 4.5 m	24
K4IPP0600	K4 IPP 0600	Instrument Cable REAN 6.3 mm Jack mono to 6.3 mm Jack mono 6 m	24
K4IPP0900	K4 IPP 0900	Instrument Cable REAN 6.3 mm Jack mono to 6.3 mm Jack mono 9 m	24
K4IPR0300	K4 IPR 0300	Instrument Cable REAN 6.3 mm Jack mono to 6.3 mm angled Jack mono 3.0 m	24
K4IPR0600	K4 IPR 0600	Instrument Cable REAN 6.3 mm Jack mono to 6.3 mm angled Jack mono 6 m	24
K4IPR0900	K4 IPR 0900	Instrument Cable REAN 6.3 mm Jack mono to 6.3 mm angled Jack mono 9 m	24
K4IRR0015	K4 IRR 0015	Instrument Cable REAN 6.3 mm angled Jack mono to 6.3 mm angled Jack mono 0.15 m	24
K4IRR0020FL	K 4 IRR 0020 FL	Instrument Cable with 6.35 mm flat plugs, mono 20 cm	25
K4IRR0030	K4 IRR 0030	Instrument Cable REAN 6.3 mm angled Jack mono to 6.3 mm angled Jack mono 0,3 m	24
K4IRR0030FL	K 4 IRR 0030 FL	Instrument Cable with 6.35 mm flat plugs, mono 30 cm	25
K4IRR0050FL	K 4 IRR 0050 FL	Instrument Cable with 6.35 mm flat plugs, mono 50 cm	25
K4IRR0060	K4 IRR 0060	Instrument Cable REAN 6.3 mm angled Jack mono to 6.3 mm angled Jack mono 0.6 m	24
K4IRR0090	K4 IRR 0090	Instrument Cable REAN 6.3 mm angled Jack mono to 6.3 mm angled Jack mono 0.9 m	24
K4IRR0100FL	K 4 IRR 0100 FL	Instrument Cable with 6.35 mm flat plugs, mono 1 m	25
K4IRR0150	K4 IRR 0150	Instrument Cable REAN 6.3 mm angled Jack mono to 6.3 mm angled Jack mono 1.5 m	24
K4IRR0300	K4 IRR 0300	Instrument Cable REAN 6.3 mm angled Jack mono to 6.3 mm angled Jack mono 3 m	24
K4IRR0300FL	K 4 IRR 0300 FL	Instrument Cable with 6.35 mm flat plugs, mono 3 m	25
K4IRR0450	K4 IRR 0450	Instrument Cable REAN 6.3 mm angled Jack mono to 6.3 mm angled Jack mono 4.5 m	24
K4IRR0600	K4 IRR 0600	Instrument Cable REAN 6.3 mm angled Jack mono to 6.3 mm angled Jack mono 6 m	24
K4IRR0600	K4 IRR 0600	Instrument Cable REAN 6.3 mm angled Jack mono to 6.3 mm angled Jack mono 6 m	26
K4IRR0600FL	K 4 IRR 0600 FL	Instrument Cable with 6.35 mm flat plugs, mono 6 m	25
K4KMMF0050	Krystal Edition	Microphone Cable OCC XLR female to XLR male 0.5 m	27
K4KMMF0100	Krystal Edition	Microphone Cable OCC XLR female to XLR male 1 m	27
K4KMMF0150	Krystal Edition	Microphone Cable OCC XLR female to XLR male 1.5 m	27
K4KMMF0250	Krystal Edition	Microphone Cable OCC XLR female to XLR male 2.5 m	27
K4KMMF0500	Krystal Edition	Microphone Cable OCC XLR female to XLR male 5.0 m	27
K4KMMF0750	Krystal Edition	Microphone Cable OCC XLR female to XLR male 7.5 m	27
K4KMMF1000	Krystal Edition	Microphone Cable OCC XLR female to XLR male 10 m	27
K4KMMF1500	Krystal Edition	Microphone Cable OCC XLR female to XLR male 15 m	27
K4KMMF2000	Krystal Edition	Microphone Cable OCC XLR female to XLR male 20 m	27
K4LS240	K4 LS 240	Speaker Cable 2 x 4.0 mm <sup>2</sup> black	93
K4LS425	K4 LS 425	Speaker Cable 4 x 2.5 mm <sup>2</sup> black	93
K4LS440	K4 LS 440	Speaker Cable 4 x 4.0 mm <sup>2</sup> black	94
K4LS825	K4 LS 825	Speaker Cable 8 x 2.5 mm <sup>2</sup> black	94
K4MFP0030	K4 MFP 0030	Microphone Cable REAN XLR female to 6.3 mm Jack mono 0.3 m	26
K4MFP0150	K4 MFP 0150	Microphone Cable REAN XLR female to 6.3 mm Jack mono 1.5 m	26
K4MFP0300	K4 MFP 0300	Microphone Cable REAN XLR female to 6.3 mm Jack mono 3 m	26
K4MFP0500	K4 MFP 0500	Microphone Cable REAN XLR female to 6.3 mm Jack mono 5 m	26
K4MFP0600	K4 MFP 0600	Microphone Cable REAN XLR female to 6.3 mm Jack mono 6 m	26
K4MFP0750	K4 MFP 0750	Microphone Cable REAN XLR female to 6.3 mm Jack mono 7.5 m	26
K4MFP0900	K4 MFP 0900	Microphone Cable REAN XLR female to 6.3 mm Jack mono 9 m	26
K4MFP1000	K4 MFP 1000	Microphone Cable REAN XLR female to 6.3 mm Jack mono 10 m	26
K4MMF0050	K4 MMF 0050	Microphone Cable REAN XLR male to XLR female 0.5 m	26
K4MMF0100	K4 MMF 0100	Microphone Cable REAN XLR male to XLR female 1 m	26
K4MMF0150	K4 MMF 0150	Microphone Cable REAN XLR male to XLR female 1.5 m	26
K4MMF0250	K4 MMF 0250	Microphone Cable REAN XLR male to XLR female 2.5 m	26
K4MMF0500	K4 MMF 0500	Microphone Cable REAN XLR male to XLR female 5 m	26
K4MMF0750	K4 MMF 0750	Microphone Cable REAN XLR male to XLR female 7.5 m	26
K4MMF1000	K4 MMF 1000	Microphone Cable REAN XLR male to XLR female 10 m	26
K4MMF1500	K4 MMF 1500	Microphone Cable REAN XLR male to XLR female 15 m	26
K4MMF2000	K4 MMF 2000	Microphone Cable REAN XLR male to XLR female 20 m	26
K4MMF3000	K4 MMF 3000	Microphone Cable REAN XLR male to XLR female 30 m	26
K4MMP0150	K4 MMP 0150	Microphone Cable REAN XLR male to 6.3 mm Jack mono 1.5 m	26
K4MMP0300	K4 MMP 0300	Microphone Cable REAN XLR male to 6.3 mm Jack mono 3 m	26
K4MMP0500	K4 MMP 0500	Microphone Cable REAN XLR male to 6.3 mm Jack mono 5 m	26
K4MMP0600	K4 MMP 0600	Microphone Cable REAN XLR male to 6.3 mm Jack mono 6 m	26
K4MMP0750	K4 MMP 0750	Microphone Cable REAN XLR male to 6.3 mm Jack mono 7.5 m	26
K4MMP0900	K4 MMP 0900	Microphone Cable REAN XLR male to 6.3 mm Jack mono 9 m	26
K4MMP1000	K4 MMP 1000	Microphone Cable REAN XLR male to 6.3 mm Jack mono 10 m	26
K4S215SS0100	K 4 S 215 SS 0100	Speaker Cable 2 x 1,5 mm <sup>2</sup> Standard Speaker Connector 2-pole to Standard Speaker Connector 2-pole 1 m	35
K4S215SS0200	K 4 S 215 SS 0200	Speaker Cable 2 x 1,5 mm <sup>2</sup> Standard Speaker Connector 2-pole to Standard Speaker Connector 2-pole 2 m	35
K4S215SS0300	K 4 S 215 SS 0300	Speaker Cable 2 x 1,5 mm <sup>2</sup> Standard Speaker Connector 2-pole to Standard Speaker Connector 2-pole 3 m	35
K4S215SS0500	K 4 S 215 SS 0500	Speaker Cable 2 x 1,5 mm <sup>2</sup> Standard Speaker Connector 2-pole to Standard Speaker Connector 2-pole 5 m	35
K4S215SS1000	K 4 S 215 SS 1000	Speaker Cable 2 x 1,5 mm <sup>2</sup> Standard Speaker Connector 2-pole to Standard Speaker Connector 2-pole 10 m	35
K4S225SS0100	K 4 S 225 SS 0100	Speaker Cable 2 x 2,5 mm <sup>2</sup> Standard Speaker Connector 2-pole to Standard Speaker Connector 2-pole 1 m	35
K4S225SS0200	K 4 S 225 SS 0200	Speaker Cable 2 x 2,5 mm <sup>2</sup> Standard Speaker Connector 2-pole to Standard Speaker Connector 2-pole 2 m	35
K4S225SS0500	K 4 S 225 SS 0500	Speaker Cable 2 x 2,5 mm <sup>2</sup> Standard Speaker Connector 2-pole to Standard Speaker Connector 2-pole 5 m	35

# REGISTER

Article no.	Model name	Description	Page
K4S225SS1000	K 4 S 225 SS 1000	Speaker Cable 2 x 2,5 mm <sup>2</sup> Standard Speaker Connector 2-pole to Standard Speaker Connector 2-pole 10 m	35
K4S225SS1500	K 4 S 225 SS 1500	Speaker Cable 2 x 2,5 mm <sup>2</sup> Standard Speaker Connector 2-pole to Standard Speaker Connector 2-pole 15 m	35
K4S225SS2000	K 4 S 225 SS 2000	Speaker Cable 2 x 2,5 mm <sup>2</sup> Standard Speaker Connector 2-pole to Standard Speaker Connector 2-pole 20 m	35
K4S240SS0200	K 4 S 240 SS 0200	Speaker Cable 2 x 4 mm <sup>2</sup> Standard Speaker Connector 2-pole to Standard Speaker Connector 2-pole 2 m	35
K4S240SS0500	K 4 S 240 SS 0200	Speaker Cable 2 x 4 mm <sup>2</sup> Standard Speaker Connector 2-pole to Standard Speaker Connector 2-pole 5 m	35
K4S240SS1000	K 4 S 240 SS 1000	Speaker Cable 2 x 4 mm <sup>2</sup> Standard Speaker Connector 2-pole to Standard Speaker Connector 2-pole 10 m	35
K4S240SS1500	K 4 S 240 SS 1500	Speaker Cable 2 x 4 mm <sup>2</sup> Standard Speaker Connector 2-pole to Standard Speaker Connector 2-pole 15 m	35
K4S240SS2000	K 4 S 240 SS 2000	Speaker Cable 2 x 4 mm <sup>2</sup> Standard Speaker Connector 2-pole to Standard Speaker Connector 2-pole 20 m	35
K4S425SS0040	K 4 S 425 SS 0040	Speaker Cable 4 x 2,5 mm <sup>2</sup> Standard Speaker Connector 4-pole to Standard Speaker Connector 4-pole 0.4 m	35
K4S425SS0300	K 4 S 425 SS 0300	Speaker Cable 4 x 2,5 mm <sup>2</sup> Standard Speaker Connector 4-pole to Standard Speaker Connector 4-pole 3 m	35
K4S425SS1000	K 4 S 425 SS 1000	Speaker Cable 4 x 2,5 mm <sup>2</sup> Standard Speaker Connector 4-pole to Standard Speaker Connector 4-pole 10 m	35
K4S425SS1500	K 4 S 425 SS 1500	Speaker Cable 4 x 2,5 mm <sup>2</sup> Standard Speaker Connector 4-pole to Standard Speaker Connector 4-pole 15 m	35
K4S425SS2000	K 4 S 425 SS 2000	Speaker Cable 4 x 2,5 mm <sup>2</sup> Standard Speaker Connector 4-pole to Standard Speaker Connector 4-pole 20 m	35
K4TCC0030	K4 TCC 0030	Audio Cable REAN 2 x RCA male to 2 x RCA male 0.3 m	30
K4TCC0060	K4 TCC 0060	Audio Cable REAN 2 x RCA male to 2 x RCA male 0.6 m	30
K4TCC0090	K4 TCC 0090	Audio Cable REAN 2 x RCA male to 2 x RCA male 0.9 m	30
K4TCC0150	K4 TCC 0150	Audio Cable REAN 2 x RCA male to 2 x RCA male 1.5 m	30
K4TCC0300	K4 TCC 0300	Audio Cable REAN 2 x RCA male to 2 x RCA male 3 m	30
K4TCC0600	K4 TCC 0600	Audio Cable REAN 2 x RCA male to 2 x RCA male 6 m	30
K4TPC0060	K4 TPC 0060	Audio Cable REAN 2 x RCA male to 2 x 6.3 mm Jack mono 0.6 m	30
K4TPC0090	K4 TPC 0090	Audio Cable REAN 2 x RCA male to 2 x 6.3 mm Jack mono 0.9 m	30
K4TPC0150	K4 TPC 0150	Audio Cable REAN 2 x RCA male to 2 x 6.3 mm Jack mono 1.5 m	30
K4TPC0300	K4 TPC 0300	Audio Cable REAN 2 x RCA male to 2 x 6.3 mm Jack mono 3 m	30
K4TPC0600	K4 TPC 0600	Audio Cable REAN 2 x RCA male to 2 x 6.3 mm Jack mono 6 m	30
K4TPP0090	K4 TPP 0090	Audio Cable REAN 2 x 6.3 mm Jack mono to 2 x 6.3 mm Jack mono 0.9 m	31
K4TPP0150	K4 TPP 0150	Audio Cable REAN 2 x 6.3 mm Jack mono to 2 x 6.3 mm Jack mono 1.5 m	31
K4TPP0300	K4 TPP 0300	Audio Cable REAN 2 x 6.3 mm Jack mono to 2 x 6.3 mm Jack mono 3 m	31
K4TPP0600	K4 TPP 0600	Audio Cable REAN 2 x 6.3 mm Jack mono to 2 x 6.3 mm Jack mono 6 m	31
K4YVMF0180	K4 YVMF 0180	Audio Cable REAN 6.3 mm Jack stereo to 1 x XLR male and 1 x XLR female 1.8 m	31
K4YVMF0300	K4 YVMF 0300	Audio Cable REAN 6.3 mm Jack stereo to 1 x XLR male and 1 x XLR female 3 m	31
K4YVPP0090	K4 YVPP 0090	Audio Cable REAN 6.3 mm Jack stereo to 2 x 6.3 mm Jack mono 0.9 m	31
K4YVPP0150	K4 YVPP 0150	Audio Cable REAN 6.3 mm Jack stereo to 2 x 6.3 mm Jack mono 1.5 m	31
K4YVPP0300	K4 YVPP 0300	Audio Cable REAN 6.3 mm Jack stereo to 2 x 6.3 mm Jack mono 3 m	31
K4YVPP0600	K4 YVPP 0600	Audio Cable REAN 6.3 mm Jack stereo to 2 x 6.3 mm Jack mono 6 m	31
K4YWCC0090	K4 YWCC 0090	Audio Cable REAN 3.5 mm Jack stereo to 2 x RCA male 0.9 m	31
K4YWCC0150	K4 YWCC 0150	Audio Cable REAN 3.5 mm Jack stereo to 2 x RCA male 1.5 m	31
K4YWCC0300	K4 YWCC 0300	Audio Cable REAN 3.5 mm Jack stereo to 2 x RCA male 3 m	31
K4YWCC0600	K4 YWCC 0600	Audio Cable REAN 3.5 mm Jack stereo to 2 x RCA male 6 m	31
K4YWFF0180	K4 YWFF 0180	Audio Cable REAN 3.5 mm Jack stereo to 2 x XLR female 1.8 m	32
K4YWFF0300	K4 YWFF 0300	Audio Cable REAN 3.5 mm Jack stereo to 2 x XLR female 3 m	32
K4YWMM0180	K4 YWMM 0180	Audio Cable REAN 3.5 mm Jack stereo to 2 x XLR male 1.8 m	32
K4YWMM0300	K4 YWMM 0300	Audio Cable REAN 3.5 mm Jack stereo to 2 x XLR male 3 m	32
K4YWPP0090	K4 YWPP 0090	Audio Cable REAN 3.5 mm Jack stereo to 2 x 6.3 mm Jack mono 0.9 m	32
K4YWPP0150	K4 YWPP 0150	Audio Cable REAN 3.5 mm Jack stereo to 2 x 6.3 mm Jack mono 1.5 m	32
K4YWPP0300	K4 YWPP 0300	Audio Cable REAN 3.5 mm Jack stereo to 2 x 6.3 mm Jack mono 3 m	32
K4YWPP0600	K4 YWPP 0600	Audio Cable REAN 3.5 mm Jack stereo to 2 x 6.3 mm Jack mono 6 m	32
K5BFV0050	K5 BFV 0050	Microphone Cable Neutrik XLR female to 6.3 mm Jack stereo 0.5 m	14
K5BFV0100	K5 BFV 0100	Microphone Cable Neutrik XLR female to 6.3 mm Jack stereo 1 m	14
K5BFV0150	K5 BFV 0150	Microphone Cable Neutrik XLR female to 6.3 mm Jack stereo 1.5 m	14
K5BFV0300	K5BFV0300	Microphone Cable Neutrik XLR female to 6.3 mm Jack stereo 3 m	14
K5BFV0500	K5 BFV 0500	Microphone Cable Neutrik XLR female to 6.3 mm Jack stereo 5 m	14
K5BFV1000	K5 BFV 1000	Microphone Cable Neutrik XLR female to 6.3 mm Jack stereo 10 m	14
K5BMV0050	K5 BMV 0050	Microphone Cable Neutrik XLR male to 6.3 mm Jack stereo 0.5 m	14
K5BMV0100	K5 BMV 0100	Microphone Cable Neutrik XLR male to 6.3 mm Jack stereo 1 m	14
K5BMV0150	K5 BMV 0150	Microphone Cable Neutrik XLR male to 6.3 mm Jack stereo 1.5 m	14
K5BMV0300	K5 BMV 0300	Microphone Cable Neutrik XLR male to 6.3 mm Jack stereo 3 m	14
K5BMV0500	K5 BMV 0500	Microphone Cable Neutrik XLR male to 6.3 mm Jack stereo 5 m	14
K5BMV1000	K5 BMV 1000	Microphone Cable Neutrik XLR male to 6.3 mm Jack stereo 10 m	14
K5BVV0050	K5 BVV 0050	Patch Cable Neutrik 6.3 mm Jack stereo to 6.3 mm Jack stereo 0.5 m	14
K5BVV0100	K5 BVV 0100	Patch Cable Neutrik 6.3 mm Jack stereo to 6.3 mm Jack stereo 1 m	14
K5BVV0150	K5 BVV 0150	Patch Cable Neutrik 6.3 mm Jack stereo to 6.3 mm Jack stereo 1.5 m	14
K5BVV0300	K5 BVV 0300	Patch Cable Neutrik 6.3 mm Jack stereo to 6.3 mm Jack stereo 3 m	14
K5BVV0500	K5 BVV 0500	Patch Cable Neutrik 6.3 mm Jack stereo to 6.3 mm Jack stereo 5 m	14
K5BVV1000	K5 BVV 1000	Patch Cable Neutrik 6.3 mm Jack stereo to 6.3 mm Jack stereo 10 m	14
K5DGH0150	K5 DGH 0150	DMX Cable Neutrik XLR male to XLR female 1.5 m	16
K5DGH0300	K5 DGH 0300	DMX Cable Neutrik XLR male to XLR female 3 m	16
K5DGH0500	K5 DGH 0500	DMX Cable Neutrik XLR male to XLR female 5 m	16
K5DGH1000	K5 DGH 1000	DMX Cable Neutrik XLR male to XLR female 10 m	16
K5DGH2000	K5 DGH 2000	DMX Cable Neutrik XLR male to XLR female 20 m	16
K5DGH3000	K5 DGH 3000	DMX Cable Neutrik XLR male to XLR female 30 m	16
K5DIJ0300	K5 DIJ 0300	DMX Cable 5-Pin-HD- Neutrik XLR male to XLR female 3 m	15
K5DIJ0500	K5 DIJ 0500	DMX Cable 5-Pin-HD- Neutrik XLR male to XLR female 5 m	15
K5DIJ1000	K5 DIJ 1000	DMX Cable 5-Pin-HD- Neutrik XLR male to XLR female 10 m	15
K5DMF0150	K5 DMF 0150	AES/EBU Cable Neutrik 110-ohm Digital Audio XLR male to XLR female 1.5 m	16
K5DMF0300	K5 DMF 0300	AES/EBU Cable Neutrik 110-ohm Digital Audio XLR male to XLR female 3 m	16
K5DMF0500	K5 DMF 0500	AES/EBU Cable Neutrik 110-ohm Digital Audio XLR male to XLR female 5 m	16
K5DMF1000	K5 DMF 1000	AES/EBU Cable Neutrik 110-ohm Digital Audio XLR male to XLR female 10 m	16
K5DMF1500	K5 DMF 1500	AES/EBU Cable Neutrik 110-ohm Digital Audio XLR male to XLR female 15 m	16
K5DMF2000	K5 DMF 2000	AES/EBU Cable Neutrik 110-ohm Digital Audio XLR male to XLR female 20 m	16
K5DMF3000	K5 DMF 3000	AES/EBU Cable Neutrik 110-ohm Digital Audio XLR male to XLR female 30 m	16



# REGISTER

Article no.	Model name	Description	Page
K5IPP0300	K5 IPP 0300	Instrument Cable Neutrik 6.3 mm Jack mono to 6.3 mm Jack mono 3 m	11
K5IPP0300SP	K5 IPP 0300 SP	Instrument Cable Neutrik silentPLUG 6.3 mm Jack mono to 6.3 mm Jack mono 3 m	10
K5IPP0450	K5 IPP 0450	Instrument Cable Neutrik 6.3 mm Jack mono to 6.3 mm Jack mono 4.5 m	11
K5JPP0600	K5 JPP 0600	Instrument Cable Neutrik 6.3 mm Jack mono to 6.3 mm Jack mono 6 m	11
K5IPP0600SP	K5 IPP 0600 SP	Instrument Cable Neutrik silentPLUG 6.3 mm Jack mono to 6.3 mm Jack mono 6 m	10
K5JPP0900	K5 JPP 0900	Instrument Cable Neutrik 6.3 mm Jack mono to 6.3 mm Jack mono 9 m	11
K5IPP0900SP	K5 IPP 0900 SP	Instrument Cable Neutrik silentPLUG 6.3 mm Jack mono to 6.3 mm Jack mono 9 m	10
K5IRP0300	K5 IRP 0300	Instrument Cable Neutrik 6.3 mm Jack mono to 6.3 mm angled Jack mono 3 m	11
K5IRP0300SP	K5 IRP 0300 SP	Instrument Cable Neutrik silentPLUG 6.3 mm angled Jack mono to 6.3 mm Jack mono 3 m	10
K5IRP0450	K5 IRP 0450	Instrument Cable Neutrik 6.3 mm Jack mono to 6.3 mm angled Jack mono 4.5 m	11
K5IRP0600	K5 IRP 0600	Instrument Cable Neutrik 6.3 mm Jack mono to 6.3 mm angled Jack mono 6 m	11
K5IRP0600SP	K5 IRP 0600 SP	Instrument Cable Neutrik silentPLUG 6.3 mm angled Jack mono to 6.3 mm Jack mono 6 m	10
K5IRP0900	K5 IRP 0900	Instrument Cable Neutrik 6.3 mm Jack mono to 6.3 mm angled Jack mono 9 m	11
K5IRP0900SP	K5 IRP 0900 SP	Instrument Cable Neutrik silentPLUG 6.3 mm angled Jack mono to 6.3 mm Jack mono 9 m	10
K5IRR0015	K5 IRR 0015	Instrument Cable Neutrik 6.3 mm angled Jack mono to 6.3 mm angled Jack mono 0.15 m	11
K5IRR0030	K5 IRR 0030	Instrument Cable Neutrik 6.3 mm angled Jack mono to 6.3 mm angled Jack mono 0.3 m	11
K5MFP0150	K5 MFP 0150	Microphone Cable Neutrik XLR female to 6.3 mm Jack mono 1.5 m	12
K5MFP0300	K5 MFP 0300	Microphone Cable Neutrik XLR female to 6.3 mm Jack mono 3 m	12
K5MFP0500	K5 MFP 0500	Microphone Cable Neutrik XLR female to 6.3 mm Jack mono 5 m	12
K5MFP1000	K5 MFP 1000	Microphone Cable Neutrik XLR female to 6.3 mm Jack mono 10 m	12
K5MMF0100	K5 MMF 0100	Microphone Cable Neutrik XLR female to XLR male 1 m	12
K5MMF0150	K5 MMF 0150	Microphone Cable Neutrik XLR female to XLR male 1.5 m	12
K5MMF0300	K5 MMF 0300	Microphone Cable Neutrik XLR female to XLR male 3 m	12
K5MMF0500	K5 MMF 0500	Microphone Cable Neutrik XLR female to XLR male 5 m	12
K5MMF0750	K5 MMF 0750	Microphone Cable Neutrik XLR female to XLR male 7.5 m	12
K5MMF1000	K5 MMF 1000	Microphone Cable Neutrik XLR female to XLR male 10 m	12
K5MMF1500	K5 MMF 1500	Microphone Cable Neutrik XLR female to XLR male 15 m	12
K5MMF2000	K5 MMF 2000	Microphone Cable Neutrik XLR female to XLR male 20 m	12
K5MMP0150	K5 MMP 0150	Microphone Cable Neutrik XLR male to 6.3 mm Jack mono 1.5 m	13
K5MMP0300	K5 MMP 0300	Microphone Cable Neutrik XLR male to 6.3 mm Jack mono 3 m	13
K5MMP0500	K5 MMP 0500	Microphone Cable Neutrik XLR male to 6.3 mm Jack mono 5 m	13
K5MMP1000	K5 MMP 1000	Microphone Cable Neutrik XLR male to 6.3 mm Jack mono 10 m	13
K5MYF0150	K5 MYF 0150	Microphone Cable Neutrik XLR female to 3.5 mm Jack stereo 1.5 m	13
K5MYF0300	K5 MYF 0300	Microphone Cable Neutrik XLR female to 3.5 mm Jack stereo 3 m	13
K5S215PP0150	K5 S215 PP 0150	Speaker Cable 2 x 1.5 mm <sup>2</sup> Neutrik 6.3 mm Jack mono to 6.3 mm Jack mono 1.5 m	17
K5S215PP0300	K5 S215 PP 0300	Speaker Cable 2 x 1.5 mm <sup>2</sup> Neutrik 6.3 mm Jack mono to 6.3 mm Jack mono 3 m	17
K5S215SS0050	K5 S215 SS 0050	Speaker Cable 2 x 1.5 mm <sup>2</sup> Neutrik Speakon 2-pole to Speakon 2-pole 0.5 m	17
K5S215SS0100	K5 S215 SS 0100	Speaker Cable 2 x 1.5 mm <sup>2</sup> Neutrik Speakon 2-pole to Speakon 2-pole 1 m	17
K5S215SS0200	K5 S215 SS 0200	Speaker Cable 2 x 1.5 mm <sup>2</sup> Neutrik Speakon 2-pole to Speakon 2-pole 2 m	17
K5S215SS0300	K5 S215 SS 0300	Speaker Cable 2 x 1.5 mm <sup>2</sup> Neutrik Speakon 2-pole to Speakon 2-pole 3 m	17
K5S215SS0500	K5 S215 SS 0500	Speaker Cable 2 x 1.5 mm <sup>2</sup> Neutrik Speakon 2-pole to Speakon 2-pole 5 m	17
K5S215SS1000	K5 S215 SS 1000	Speaker Cable 2 x 1.5 mm <sup>2</sup> Neutrik Speakon 2-pole to Speakon 2-pole 10 m	17
K5S225PS0150	K5 S225 PS 0150	Speaker Cable 2 x 2.5 mm <sup>2</sup> Neutrik Speakon 2-pole to 6.3 mm Jack mono 1.5 m	18
K5S225PX0030	K5 S225 PX 0030	Speaker Cable 2 x 2.5 mm <sup>2</sup> Neutrik Speakon 4-pole to 6.3 mm Jack mono 0.3 m	18
K5S225SS0100	K5 S225 SS 0100	Speaker Cable 2 x 2.5 mm <sup>2</sup> Neutrik Speakon 2-pole to Speakon 2-pole 1 m	18
K5S225SS0200	K5 S225 SS 0200	Speaker Cable 2 x 2.5 mm <sup>2</sup> Neutrik Speakon 2-pole to Speakon 2-pole 2 m	18
K5S225SS0300	K5 S225 SS 0300	Speaker Cable 2 x 2.5 mm <sup>2</sup> Neutrik Speakon 2-pole to Speakon 2-pole 3 m	18
K5S225SS0500	K5 S225 SS 0500	Speaker Cable 2 x 2.5 mm <sup>2</sup> Neutrik Speakon 2-pole to Speakon 2-pole 5 m	18
K5S225SS1000	K5 S225 SS 1000	Speaker Cable 2 x 2.5 mm <sup>2</sup> Neutrik Speakon 2-pole to Speakon 2-pole 10 m	18
K5S225SS1500	K5 S225 SS 1500	Speaker Cable 2 x 2.5 mm <sup>2</sup> Neutrik Speakon 2-pole to Speakon 2-pole 15 m	18
K5S225SS1500	K5 S225 SS 1500	Speaker Cable 2 x 2.5 mm <sup>2</sup> Neutrik Speakon 2-pole to Speakon 2-pole 15 m	20
K5S240NN0200	K5 S240 NN 0200	Speaker Cable 2 x 4 mm <sup>2</sup> Neutrik Speakon 4-pole to Speakon 4-pole 2 m	19
K5S240NN0300	K5 S240 NN 0300	Speaker Cable 2 x 4 mm <sup>2</sup> Neutrik Speakon 4-pole to Speakon 4-pole 3 m	19
K5S240NN1000	K5 S240 NN 1000	Speaker Cable 2 x 4 mm <sup>2</sup> Neutrik Speakon 4-pole to Speakon 4-pole 10 m	19
K5S240NN1500	K5 S240 NN 1500	Speaker Cable 2 x 4 mm <sup>2</sup> Neutrik Speakon 4-pole to Speakon 4-pole 15 m	19
K5S240NN2000	K5 S240 NN 2000	Speaker Cable 2 x 4 mm <sup>2</sup> Neutrik Speakon 4-pole to Speakon 4-pole 20 m	19
K5S425NN0040	K5 S425 NN 0040	Speaker Cable 4 x 2.5 mm <sup>2</sup> Neutrik Speakon 4-pole to Speakon 4-pole 0.4 m	20
K5S425NN0300	K5 S425 NN 0300	Speaker Cable 4 x 2.5 mm <sup>2</sup> Neutrik Speakon 4-pole to Speakon 4-pole 3 m	20
K5S425NN1000	K5 S425 NN 1000	Speaker Cable 4 x 2.5 mm <sup>2</sup> Neutrik Speakon 4-pole to Speakon 4-pole 10 m	20
K5S425NN1500	K5 S425 NN 1500	Speaker Cable 4 x 2.5 mm <sup>2</sup> Neutrik Speakon 4-pole to Speakon 4-pole 15 m	20
K5S425NN2000	K5 S425 NN 2000	Speaker Cable 4 x 2.5 mm <sup>2</sup> Neutrik Speakon 4-pole to Speakon 4-pole 20 m	20
K8C10	K 8 C 10	Stage Box 8/0 10 m	118
K8C15P	K 8 C 15 P	Stage Box 8/0 15 m	120
KCBSP602B	BSP 602 B	Pigtail Adapter HDMI 19 female to HDMI 19 female with Fixing Screws black	144
KCCAB40010	CAB 400 10	Power and Microphone Cable Earthing Contact & XLR female to Euro Power & XLR male 10 m	127
KCCAB40015	CAB 400 15	Power and Microphone Cable Earthing contact & XLR female to Euro Power & XLR male 15 m	127
KCCAB40020	CAB 400 20	Power and Microphone Cable Earthing contact & XLR female to Euro Power & XLR male 20 m	127
KCCAB4005	CAB 400 5	Power and Microphone Cable Earthing contact & XLR female to Euro Power & XLR male 5 m	127
KCCAB40515	CAB 405 15	Power and Microphone Cable, Earthing contact & XLR female to Euro Power & XLR male 15 m	129
KCCAB40520	CAB 405 20	Power and Microphone Cable, Earthing contact & XLR female to Euro Power & XLR male 20 m	129
KCCAB4055	CAB 405 5	Power and Microphone Cable Schuko Power & XLR female to Euro Power & XLR male 5 m	128
KCCAB440150	ProCab Series CAB 440	Power Cable blue PowerCon to grey PowerCon 1.5 m	131
KCCAB440300	KC CAB 440 300	Power Cable blue PowerCon to grey PowerCon 3.0 m	131
KCCAB440500	KC CAB 440 500	Power Cable blue PowerCon to grey PowerCon 5 m	131
KCCAB442150	CAB 442 150	Power Cable blue PowerCon to earthing contact male 1.5 m	131
KCCAB448150G	CAB 448 150 G	Power Cable grey PowerCon to earthing contact female Germany 1.5 m	131
KCCAV11415	CAV 114 15	Video Cable SVGA male to SVGA male 15 m	146
KCCAV11420	CAV 114 20	Video Cable SVGA male to SVGA male 20 m	146
KCCAV11425	CAV 114 25	Video Cable SVGA male to SVGA male 25 m	146
KCCAV1143	CAV 114 3	Video Cable SVGA male to SVGA male 3 m	146

# REGISTER

Article no.	Model name	Description	Page
KCCA11430	CAV 114 30	Video Cable SVGA male to SVGA male 30 m	146
KCCIP7082	CIP 708 2	Audio Cable 3.5 mm Jack stereo male to 3.5 mm Jack stereo male 2 m	141
KCCXV107	CXV 107	Coax Video Cable 0.54 mm <sup>2</sup> green	87
KCDMX30	DMX 30	DMX Cable 2 x 0.23 mm <sup>2</sup>	87
KCLS215W	LS 215 W	Speaker Cable 2 x 1.5 mm <sup>2</sup> white	92
KCPAC50	PAC 50	Audio and Power Cable 2 x 0.125 mm <sup>2</sup> + 3 x 1 mm <sup>2</sup>	90
KPCPC3G15	PC 3G15	Power Cable 3 x 1.5 mm <sup>2</sup>	90
KCREF600150	REF 600 150	Instrument Cable 6.3 mm Jack mono to 6.3 mm Jack mono 1.5 m	147
KCREF6003	REF 600 3	Instrument Cable 6.3 mm Jack mono to 6.3 mm Jack mono 3 m	147
KCREF61010	REF 610 10	Instrument Cable 6.3 mm Jack stereo to 6.3 mm Jack stereo 10 m	146
KCREF610150	REF 610 150	Instrument Cable 6.3 mm Jack stereo to 6.3 mm Jack stereo 1.5 m	146
KCREF6103	REF 610 3	Instrument Cable 6.3 mm Jack stereo to 6.3 mm Jack stereo 3 m	146
KCREF6105	REF 610 5	Instrument Cable 6.3 mm Jack stereo to 6.3 mm Jack stereo 5 m	146
KCREF612150	REF 612 150	Audio Cable 3.5 mm Jack stereo to 3.5 mm Jack stereo 1.5 m	134
KCREF6123	REF 612 3	Audio Cable 3.5 mm Jack stereo to 3.5 mm Jack stereo 3 m	134
KCREF6125	REF 612 5	Audio Cable 3.5 mm Jack stereo to 3.5 mm Jack stereo 5 m	134
KCREF631150	REF 631 150	Audio Cable 2 x 6.3 mm Jack mono to 2 x RCA male 1.5 m	134
KCREF6313	REF 631 3	Audio Cable 2 x 6.3 mm Jack mono to 2 x RCA male 3 m	134
KCREF6315	REF 631 5	Audio Cable 2 x 6.3 mm Jack mono to 2 x RCA male 5 m	134
KCREF701150	REF 701 150	Audio Cable 2 x XLR male to 2 x RCA male 1.5 m	135
KCREF7013	REF 701 3	Audio Cable 2 x XLR male to 2 x RCA male 3 m	135
KCREF703150	REF 703 150	Audio Cable XLR male to 2 x RCA male 1.5 m	135
KCREF7033	REF 703 3	Audio Cable XLR male to 2 x RCA male 3 m	135
KCREF704150	REF 704 150	Audio Cable XLR female to 2 x RCA male 1.5 m	136
KCREF705150	REF 705 150	Audio Cable 2 x XLR female to 2 x RCA male 1.5 m	136
KCREF7053	REF 705 3	Audio Cable 2 x XLR female to 2 x RCA male 3 m	136
KCREF707150	REF 707 150	Audio Cable 2 x XLR female to 2 x 6.3 mm Jack mono 1.5 m	137
KCREF7073	REF 707 3	Audio Cable 2 x XLR female to 2 x 6.3 mm Jack mono 3 m	137
KCREF708150	REF 708 150	Audio Cable 2 x XLR male to 2 x 6.3 mm Jack mono 1.5 m	137
KCREF7083	REF 708 3	Audio Cable 2 x XLR male to 2 x 6.3 mm Jack mono 3 m	137
KCREF7093	REF 709 3	Audio Cable 6.3 mm Jack stereo to 1 x XLR male and 1 x XLR female 3 m	138
KCREF7095	REF 709 5	Audio Cable 6.3 mm Jack stereo to 1 x XLR male and 1 x XLR female 5 m	138
KCREF710050	REF 710 050	Audio Cable 2 x XLR female to 2 x XLR male 0.5 m	138
KCREF710150	REF 710 150	Audio Cable 2 x XLR female to 2 x XLR male 1.5 m	138
KCREF7103	REF 710 3	Audio Cable 2 x XLR female to 2 x XLR male 3 m	138
KCREF71110	REF 711 10	Audio Cable 3.5 mm Jack stereo to 2 x RCA male 10 m	139
KCREF711150	REF 711 150	Audio Cable 3.5 mm Jack stereo to 2 x RCA male 1.5 m	139
KCREF7113	REF 711 3	Audio Cable 3.5 mm Jack stereo to 2 x RCA male 3 m	139
KCREF7115	REF 711 5	Audio Cable 3.5 mm Jack stereo to 2 x RCA male 5 m	139
KCREF712150	REF 712 150	Audio Cable 3.5 mm Jack stereo to 2 x XLR male 1.5 m	141
KCREF7123	REF 712 3	Audio Cable 3.5 mm Jack stereo to 2 x XLR male 3 m	141
KCREF713150	REF 713 150	Audio Cable 3.5 mm Jack stereo to 2 x 6.3 mm Jack mono 1.5 m	139
KCREF7133	REF 713 3	Audio Cable 3.5 mm Jack stereo to 2 x 6.3 mm Jack mono 3 m	139
KCREF714150	REF 714 150	Audio Cable 1 x 3.5 mm Jack stereo to XLR male 1.5 m	142
KCREF719150	REF 719 150	Audio Cable 6.3 mm Jack stereo to 2 x RCA male 1.5 m	140
KCREF7193	REF 719 3	Audio Cable 6.3 mm Jack stereo to 2 x RCA male 3 m	140
KCREF721150	REF 721 150	Audio Cable 6.3 mm Jack stereo to 2 x 6.3 Jack mono 1.5 m	140
KCREF7213	REF 721 3	Audio Cable 6.3 mm Jack stereo to 2 x 6.3 Jack mono 3 m	140
KCREF723150	REF 723 150	Microphone Cable XLR female to 6.3 mm Jack stereo 1.5 m	142
KCREF724150	REF 724 150	Microphone Cable XLR male to 6.3 mm Jack stereo 1.5 m	147
KCREF7243	REF 724 3	Microphone Cable XLR male to 6.3 mm Jack stereo 3 m	147
KCREF7245	REF 724 5	Microphone Cable XLR male to 6.3 mm Jack stereo 5 m	147
KCREF735150	REF 735 150	Audio Cable XLR female to 2 x XLR male 1.5 m	143
KCREF736150	REF 736 150	Audio Cable XLR male to 2 x XLR female 1.5 m	143
KCREF790090	REF 790 090	Patch Cable Set 6.3 mm Jack stereo to 6.3 mm angled Jack stereo 0.9 m	145
KCREF792090	REF 792 090	Patch Cable Set 6.3 mm Jack stereo to 6.3 mm Jack stereo 0.9 m	145
KCREF800050	REF 800 050	Audio Cable 2 x RCA male to 2 x RCA male 0.5 m	144
KCREF8001	REF 800 1	Audio Cable 2 x RCA male to 2 x RCA male 1 m	144
KCREF800150	REF 800 150	Audio Cable 2 x RCA male to 2 x RCA male 1.5 m	144
KCREF8003	REF 800 3	Audio Cable 2 x RCA male to 2 x RCA male 3 m	144
KCREF8005	REF 800 5	Audio Cable 2 x RCA male to 2 x RCA male 5 m	144
KCSIG48	SIG 48	Twin Cable 2 x 0.16 mm <sup>2</sup>	89
KCSIG58	SIG 58	Twin Cable stereo 4 x 0.16 mm <sup>2</sup>	89
KCVCD70	KCVCD 70	BNC Socket double female D-Type, 75 Ohms	67
KCVCD72	KCVCD 72	BNC Socket female D-Type	68
KIK125T	KIK 125 T	Twin Cable 2 x 0.25 mm <sup>2</sup>	90
KIK150	Player 150	Instrument Cable 1 x 0.50 mm <sup>2</sup>	85
KLP1	KLP 1	AES/EBU Power Combination Cable 2 x 0.14 mm <sup>2</sup> + 3 x 1.5 mm <sup>2</sup>	91
KLP2	KLP 2	AES/EBU Power Combination Cable 4 x 0.14 mm <sup>2</sup> + 3 x 1.5 mm <sup>2</sup>	91
KLP4	KLP 4	AES/EBU Power Combination Cable 8 x 0.14 mm <sup>2</sup> + 3 x 1.5 mm <sup>2</sup>	91
KLS207FLB	KLS 207 FLB	Multiwire Speaker Cable 2 x 0.75 mm <sup>2</sup> black	94
KLS207FLW	KLS 207 FLW	Multiwire Speaker Cable 2 x 0.75 mm <sup>2</sup> white	94
KLS215	KLS 215	Speaker Cable 2 x 1.5 mm <sup>2</sup>	92
KLS215FLB	KLS 215 FLB	Multiwire Speaker Cable 2 x 1.5 mm <sup>2</sup> black	94
KLS215TC	Twincord 215	Speaker Cable 2 x 1.5 mm <sup>2</sup> transparent	92
KLS225	KLS 225	Speaker Cable 2 x 2.5 mm <sup>2</sup>	93
KLS225FLB	KLS 225 FLB	Multiwire Speaker Cable 2 x 2.5 mm <sup>2</sup> black	94
KLS240FLB	KLS 240 FLB	Multiwire Speaker Cable 2 x 4.0 mm <sup>2</sup> black	94
KMK222B	Omega 222 B	Microphone Cable 2 x 0.34 mm <sup>2</sup> blue	83
KMK222R	Omega 222 R	Microphone Cable 2 x 0.34 mm <sup>2</sup> red	83

# REGISTER

Article no.	Model name	Description	Page
KMK222S	Omega 222 S	Microphone Cable 2 x 0.34 mm <sup>2</sup>	83
KMK222STB	The Stage B	Microphone Cable 2 x 0.22 mm <sup>2</sup> blue	84
KMK222STG	The Stage G	Microphone Cable 2 x 0.22 mm <sup>2</sup> green	84
KMK222STGR	The Stage GR	Microphone Cable 2 x 0.22 mm <sup>2</sup> ice grey	84
KMK222STR	The Stage R	Microphone Cable 2 x 0.22 mm <sup>2</sup> red	84
KMK222STS	The Stage S	Microphone Cable 2 x 0.22 mm <sup>2</sup>	84
KMK222STV	The Stage V	Microphone Cable 2 x 0.22 mm <sup>2</sup> violet	84
KMK222STY	The Stage Y	Microphone Cable 2 x 0.22 mm <sup>2</sup> yellow	84
KMK234AEB	KMK 234 AES B	AES/EBU and DMX Cable 110-ohm digital blue	87
KMK234AES	KMK 234 AES S	AES/EBU and DMX Cable 110-ohm digital black	87
KMK250S	Sigma 250 S	Microphone Cable 2 x 0.50 mm <sup>2</sup>	84
KMKP222B	Omega Pro 222 B	Microphone Cable 2 x 0.22 mm <sup>2</sup> blue	83
KMKP222B	Omega Pro 222 B	Microphone Cable 2 x 0.22 mm <sup>2</sup> blue	84
KMKP222R	Omega Pro 222 R	Microphone Cable 2 x 0.22 mm <sup>2</sup> red	83
KMKP222R	Omega Pro 222 R	Microphone Cable 2 x 0.22 mm <sup>2</sup> red	84
KMKP222S	Omega Pro 222 S	Microphone Cable 2 x 0.22 mm <sup>2</sup>	83
KMKP222S	Omega Pro 222 S	Microphone Cable 2 x 0.22 mm <sup>2</sup>	84
KQMC02	Quantum 02	Multicore Cable 2-channel 4 x 0.14 mm <sup>2</sup>	95
KQMC04	Quantum 04	Multicore Cable 4-channel 8 x 0.14 mm <sup>2</sup>	95
KQMC08	Quantum 08	Multicore Cable 8-channel 16 x 0.14 mm <sup>2</sup>	95
KQMC10	Quantum 10	Multicore Cable 10-channel 20 x 0.14 mm <sup>2</sup>	95
KQMC12	Quantum 12	Multicore Cable 12-channel 24 x 0.14 mm <sup>2</sup>	95
KQMC16	Quantum 16	Multicore Cable 16-channel 32 x 0.14 mm <sup>2</sup>	95
KQMC20	Quantum 20	Multicore Cable 20-channel 40 x 0.14 mm <sup>2</sup>	95
KQMC24	Quantum 24	Multicore Cable 24-channel 48 x 0.14 mm <sup>2</sup>	95
KQMC32	Quantum 32	Multicore Cable 32-channel 64 x 0.14 mm <sup>2</sup>	95
KQMC40	Quantum 40	Multicore Cable 40-channel 80 x 0.14 mm <sup>2</sup>	95
KQMC48	Quantum 48	Multicore Cable 48-channel 96 x 0.14 mm <sup>2</sup>	95
KSC04	KSC 04	Multicore Cable 4-channel 8 x 0.22 mm <sup>2</sup> with Numerical Code	96
KSC08	KSC 08	Multicore Cable 8-channel 16 x 0.22 mm <sup>2</sup> with Numerical Code	96
KSC12	KSC 12	Multicore Cable 12-channel 24 x 0.22 mm <sup>2</sup> with Numerical Code	96
KSC16	KSC 16	Multicore Cable 16-channel 32 x 0.22 mm <sup>2</sup> with Numerical Code	96
KSC20	KSC 20	Multicore Cable 20-channel 40 x 0.22 mm <sup>2</sup> with Numerical Code	96
KSC24	KSC 24	Multicore Cable 24-channel 48 x 0.22 mm <sup>2</sup> with Numerical Code	96
KSC32	KSC 32	Multicore Cable 32-channel 64 x 0.22 mm <sup>2</sup> with Numerical Code	96
KSCP3	KSCP 3	Converter Safety Plug /UK black 13 A	126
KSFCP	KSF CP	Converter Plug Euro/UK black 5 A	127
NA3FF	NA 3 FF	Adapter XLR female to XLR female	79
NA3MM	NA 3 MM	Adapter XLR male to XLR male	79
NAC3FCA	NAC 3 FCA	PowerCon Plug blue	76
NAC3FCB	NAC 3 FCB	PowerCon Plug grey	76
NAC3MPA-1	NAC 3 MPA-1	PowerCon Socket blue	76
NAC3MPB-1	NAC 3 MPB	PowerCon Socket grey	76
NC3FDL1	NC 3 FDL 1	XLR Chassis Connector female	77
NC3FDL1BAG	NC 3 FDL 1 BAG	XLR Chassis Connector female black	77
NC3FX	NC 3 FX	XLR Plug female	76
NC3FXBAG	NC 3 FXBAG	XLR Plug female black	76
NC3FXX	NC 3 FXX	XLR Plug female	77
NC3FXXBAG	NC 3 FXXBAG	XLR Plug female black	77
NC3MDL1BAG	NC 3 MDL 1 BAG	XLR Chassis Connector male black	77
NC3MX	NC 3 MX	XLR Plug male	76
NC3MXBAG	NC 3 MXBAG	XLR Plug male black	76
NC3MXX	NC 3 MXX	XLR Plug male	77
NC3MXXBAG	NC 3 MXXBAG	XLR Plug male black	77
NE8FDPB	NE 8 FDPB	RJ45 Feedthrough Receptacle	78
NL2FX	NL 2 FX	Speakon Plug 2-pole	77
NL4FC	NL 4 FC	Speakon Plug 4-pole	77
NL4FX	NL 4 FX	Speakon Plug 4-pole	78
NL4MMX	NL 4 MMX	Adapter Speakon 2/4-pole to Speakon 2/4-pole	78
NL4MP	NL 4 MP	Speakon Chassis Connector	78
NL4MPR	NL 4 MPR	Speakon Chassis Connector round	78
NL8FC	NL 8 FC	Speakon Plug 8-pole	78
S22	S 22	Microphone stand with round base	160
S4B	S 4 B	Tabletop microphone stand	162
S5B	S 5 B	Microphone stand with boom arm	160
S5BE	S 5 BE	Microphone stand black with boom arm	160
S6B	S 6 B	Microphone stand with boom arm	161
S7B	S 7 B	Microphone stand with round base and boom arm	161
S8B	S 8 B	Tabletop microphone stand	162
S8BB	S 8 BB	Tabletop microphone stand	162
S9B	S 9 B	Microphone Stand small with Boom Arm	161
SCBCLMP	SCBCLMP	Cabinet clamp for Microphone	187
SCP710B	SUPER CLAMP	Universal Hook Clamp with Toggle black	206
SCS19	SCS 19	Cable holder for wall mounting	208
SDH1	SDH 1	Drink holder	208
SDMSB190	SDMSB 190	Stereo Bar for 2 Microphones	165
SGS017	SGS 017	Guitar Footrest	186
SGS101	SGS 101	Guitar stands	186
SGS103	SGS 103	Universal Guitar Stand	186
SGWH1	SGWH 1	Guitar wall hanger	187

# REGISTER

Article no.	Model name	Description	Page
SHPH1	SHPH 1	Headphone Holder	209
SKDB039	SKDB 039	Speaker stands	156
SKS01	SKS 01	Keyboard Stand black	182
SKS024	SKS 024	Keyboard stand extension / stacker	182
SKS03	SKS 03	Keyboard stands	182
SKS04	SKS 04	Keyboard Stand black	182
SKS05	SKS 05	Keyboard stands	183
SKS22MB	SKS 22 MB	Boom Arm for SKS22XB Keyboard Stand 2-piece extendable	182
SKS22XB	SKS 22 XB	Double keyboard stand	183
SKS22XBAG	SKS 22 XBAG	Gig Bag for Double Keyboard Stand SKS22XB	183
SKT16E	SKT 16 E	Folding Keyboard Bench	183
SKT17	SKT 17	Folding Keyboard Bench With Extra Thick Padding	183
SLED10	SLED 10	LED Light for Music Stand	196
SLED1BULTRA	SLED 1 B ULTRA	Gooseneck Light with Surface Mount Base	199
SLED1BXHR3	SLED 1 B XLR 3	Surface Mount 3-pin XLR Gooseneck Light Base with Power Adapter	199
SLED1PRO	SLED 1 PRO	LED Light for Music Stand	197
SLED1ULTRABNC	SLED 1 ULTRABNC	BNC Gooseneck Light with 4 COB LEDs	201
SLED1ULTRAUSB	SLED 1 ULTRAUSB	Gooseneck Lamp, USB connector, 4 COB LEDs	201
SLED1ULTRAXLR3	SLED 1 ULTRA XLR 3	3-pin XLR Gooseneck Light with 4 COB LEDs	201
SLED1ULTRAXLR3A	SLED 1 ULTRAXLR 3 A	Angled 3-pin XLR Gooseneck Light with 4 COB LEDs	201
SLED1ULTRAXLR3AC	SLED 1 ULTRAXLR 3 AC	Angled 3-pin XLR Gooseneck Light with 4 COB LEDs and selectable colours	202
SLED1ULTRAXLR3C	SLED 1 ULTRAXLR 3 C	3-pin XLR Gooseneck Light with 4 COB LEDs and selectable colours	202
SLED1ULTRAXLR4	SLED 1 ULTRAXLR 4	4-pin XLR Gooseneck Light with 4 COB LEDs	201
SLED1ULTRAXLR4A	SLED 1 ULTRAXLR 4 A	Angled 4-pin XLR Gooseneck Light with 4 COB LEDs	201
SLED1ULTRAXLR4AC	SLED 1 ULTRAXLR 4 AC	Angled 4-pin XLR Gooseneck Light with 4 COB LEDs and selectable colours	202
SLED1ULTRAXLR4C	SLED 1 ULTRAXLR 4 C	4-pin XLR Gooseneck Light with 4 COB LEDs and selectable colours	202
SLED1USBPRO	SLED 1 USB PRO	USB Gooseneck Lamp with 2 LEDs	200
SLED24PRO	SLED 24 PRO	LED Light for Music Stand	198
SLED2PRO	SLED 2 PRO	LED Light for Music Stand	197
SLED2PROW	SLED 2 PRO W	LED Light for Music Stand white	197
SLED2ULTRA	SLED 2 ULTRA	Clip-On Dual Gooseneck Light	198
SLEDPL10B	SLED PL 10 B	LED Piano Lamp with 10 LEDs	196
SLEDPSUSB	SLED PS USB	Universal 5 V Power Adapter USB/DC (DC Plug)	200
SLEDPSUSBK	SLED PS USB UK	Universal 5 V Power Adapter USB/DC (DC Plug)	200
SLS36TV28	SLS 36 TV 28	Adapter 28 mm (TV Spigot) to 35 mm	173
SLS6	SLS 6	Lighting Stand	170
SLS6CB	SLS 6 CB	Lighting Stand T-Bar with 17 mm TV Spigot	170
SLSCB1	CROSSBAR 1	Tripod lateral crossbar for up to 4 lights	174
SLSTRS400	SLSTRS 400	Truss and Tripod Wind-Up Stand Set	169
SLSTV28M10	SLS TV28 M10	28 mm TV Spigot with M10 Thread	173
SLT001	SLT 001	Laptop stand with clamp	178
SLT001E	SLT 001 E	Laptop stand	178
SLT001EW	SLT 001 EW	Laptop Stand White	178
SLT001TRAY	SLT 001 TRAY	Storage Tray for Laptop Stands SLT001 / SLT001E	178
SLT001W	SLT 001 W	Laptop Stand with Clamp white	178
SLT003	SLT 003	Laptop stand	179
SLT006B	SLT 006 B	Foldable Laptop Stand with Tray black	179
SLT006S	SLT 006 S	Foldable Laptop Stand with Tray silver	179
SLTS017	SLTS 017	Lighting Stand large with TV Spigot Adapter	172
SLTS017CB	SLTS 017 CB	Lighting Stand T-Bar with 28 mm TV Spigot	172
SLTS017E	SLTS 017 E	Lighting Stand large with TV Spigot Adapter	172
SLTS09	SLTS 09	Lighting Stand medium	171
SLTS09CB	SLTS 09 CB	Lighting Stand T-Bar with 23 mm TV Spigot	171
SLTSBAG	SLTSBAG	Transport Bag for 2 Lighting Stands	174
SM700	SM 700	Cabinet Flange	212
SM701	SM 701	Cabinet Flange	212
SM702	SM 702	Cabinet Flange	212
SM707	SM 707	Cabinet Flange	213
SM707G	SM 707 G	Gasket for SM 707 Cabinet Flange	213
SM720	SM 720	Mounting Flange with M20 Thread	213
SM7DT	SM 7 DT	Dual-tilt flange (0°/5°)	213
SMBS5	SMBS 5	Wall mount for speakers, black	153
SMBS5W	SMBS 5 W	Wall mount for speakers, white	153
SMICBAG	SMICBAG	Transport Bag for 2 Microphone Stands	163
SMS11	SMS 11	Music stand	191
SMS11PRO	SMS 11 PRO	Telescopic music stand, small incl. bag	192
SMS14PRO	SMS 14 PRO	Professional Microphone Stand Holder for iPads	208
SMS17	SMS 17	Music stand	190
SMS17SET1	SMS 17 SET 1	Music stand with LED Light	193
SMS19	SMS 19	Music stand	190
SMS2	SMS 2	Perforated Music Stand	191
SPADECO1	PAD ECO 1	Isolation Pad for Studio Monitors 170 x 300 mm	156
SPADECO2	PAD ECO 2	Isolation Pad for Studio Monitors 265 x 330 mm	156
SPS023	SPS 023	Speaker stands black	150
SPS023BAG	SPS 023 BAG	Transport Bag for 2 Speaker Stands	152
SPS023S	SPS 023 S	Speaker stands silver	150
SPS023SET	SPS 023 SET	Speaker Stand Set 2 Speaker Stands with Bag	152
SPS023SET2	SPS 023 SET 2	Set of 2 Speaker Stands with Bag and Standard Speaker Cables	152
SPS023SET3	SPS 023 SET 3	Set of 2 Speaker Stands with Bag and 2 XLR Cables	152
SPS023SET4	SPS 023 SET 4	Set of 2 Speaker Stands with Bag and 2 Speaker Cables 6.3 mm Jack	152



# REGISTER

Article no.	Model name	Description	Page
SPS36M10	SPS 36 M10	Adapter flange 36mm to M10 thread	155
SPS36M10I	SPS 36 M10 I	Adapter flange 36mm to M10 inner thread	155
SPS36M38	SPS 36 M38	Reducer Flange 36mm to 3/8" thread	155
SPS36M6	SPS 36 M6	Reducer Flange 36mm to M6 thread	155
SPS36S16	SPS 36 S 16	Adapter flange 36mm to 16mm	155
SPS36TV28	SPS 36 TV 28	Reducer Flange 36mm to 28mm (TV Spigot)	155
SPS54B	SPS 54 B	Speaker stands	150
SPS56B	SPS 56 B	Speaker stands	151
SPS56S	SPS 56 S	Speaker stand silver	151
SPS57	SPS 57	Mounting Bracket for Speakers	153
SPS821	SPS 821	Speaker Pole	151
SPS822	SPS 822	Speaker Pole M20 Thread	151
SPS823	SPS 823	Mounting fork for speaker stands	154
SPSG3B	SPSG 3 B	Wall mount for speakers	154
STRA36	TRA 36	Truss adapter for 35 mm tripod mounts	154
STRA36V	TRA 36 V	Vertical Truss Adapter 35 mm for 2 Point Truss	154
STRS12U	STRS 12 U	Rack Stand 12 U	207
STRS6U	STRS 6 U	Rack Stand 6 U	207
SUWMB10B	SUWMB 10 B	Universal Wall mount for speakers up to 10kg black	153
SUWMB10W	SUWMB 10 W	Universal Wall mount for speakers up to 10kg white	153
SWU375	SWU 375	Wind up stand black	168
SWU375FR	SWU 375 FR	Step for SWU 375 Wind Up Stand black	168
SWU400T	SWU 400 T	Wind up stand with T-Bar black	169





**Adam Hall GmbH**

Headquarters

Daimlerstr. 9  
D- 61267 Neu-Anspach  
Germany  
Tel.: (+49) 60 81 / 94 19 0  
Tel.: (+49) 60 81 / 94 19 1000  
E-mail: mail@adamhall.com

**Adam Hall UK**

Tel.: (+44) 0 17 02 61 39 22  
mail.uk@adamhall.com

**Adam Hall**

Spain/France/Portugal/Italy

Carrer Ramón Turró 124  
08005 Barcelona  
Tel. Spain: (+34) 93 363 53 63  
Tel. France: (+33) 4 67 66 27 87  
Tel. Italy 0800 87 39 16  
mail.sp@adamhall.com  
mail.fr@adamhall.com  
mail.pt@adamhall.com  
mail.it@adamhall.com

**Adam Hall Scandinavia**

Tel.: (+45) 36 70 05 27  
mail.dk@adamhall.com

**Adam Hall Benelux**

Tel.: +31 (0) 611281874  
mail.benelux@adamhall.com

**Adam Hall Poland**

Tel.: +48 (0) 782 510 410  
mail.pl@adamhall.com

**Adam Hall**

Slovenia/Croatia/Hungary/  
South Eastern Europe

Tel.: (+386) 51 478 581  
mail.si@adamhall.com

**Adam Hall Asia**

11 Woodlands Close, #01-12  
Singapore 737853  
Tel.: (+65) 315293  
asia@adamhall.com

**EDITION 2017**

The information and numerical data contained in this publication has been prepared as a general guide to the products, potential buyers and users must however satisfy themselves as to the suitability and the applicability of the products for their particular purposes and duties. No responsibility is assumed for any errors herein. The company reserves the right to alter the designs, materials and specifications of the products shown in this publication without notice.