

Mirage Dig Evolution
Broadcast Audio Processor
DSP powered



Guarantee

The equipment is warranted for a period of 2 years from the date of invoice (ex-works). The warranty does not cover faults provoked by carelessness, natural causes and parts subject to wear. In addition, the cost of shipment is not covered. The warranty will be voided if the equipment is mishandled.

Technical Support

If you require technical support, contact AEV SERVICE giving a clear and concise account of your specific problem. Quote the serial number of your equipment by referring to the AEV name-plate attached to the equipment itself as this is the most important piece of information to be provided.

Telephone: +39 051 6630904 Fax: +39 051 893605

Factory Service and Repairs

If problems arise while the equipment is being installed, consult this manual and check that the installation is being carried out properly. If the problems still cannot be solved, call the AEV SERVICE Department for further information. If the problem is a minor one we can a telephone call will probably enough. If, on the other hand, the equipment is to be shipped to AEV for service or repairs.

Shipping Instruction

When shipping the equipment to AEV, use the original package in order to be certain that it will be fully protected during handling. If you need the original package, call us for a new one.

If you ship the equipment in a different packing container, take care to provide a double package by interposing padding material between the two containers in order to fully protect the equipment during shipment. The package should be marked "FRAGILE" in red.

Remember that the RMA number must be clearly visible on the package. If it is not, the equipment will not be accepted.

IMPORTANT: Carefully read this paragraph as it contains important instructions concerning operator safety and directions regarding the installation, operation and maintenance of the equipment. Failure to observe the safety instructions and information given in this manual **constitutes an infringement of the safety rules and design specifications provided for this piece of equipment.**

AEV Broadcast Srl declines all responsibility if any one of the safety rules given here in is not observed.

AEV Broadcast Srl declines all responsibility if the end-user resells the product.

The equipment is to be used by people capable of operating it in a trouble-free manner and **it is assumed that they are aware of the following safety rules.**

- Keep this manual with the utmost care and close at hand so that it can be consulted whenever needed
- After unpacking the equipment, check it for condition.
- Avoid banging the equipment.
- The packing material (plastic bags, polystyrene, nails, etc.) must never be left within the reach of the children, as **these items are potential sources of danger.**
- Do not use the equipment in places where the temperature is not within the recommended range, as specified by the manufacturer.
- Before connecting the equipment, make sure the nameplate specifications correspond to the mains electricity supply (the nameplate is located on the equipment enclosure).
- Do not remove the sticker from the equipment as it contains important specifications and the relevant serial number.
- To join the equipment to the mains supply, use the power cord purchased with the equipment.
- The equipment must be used only for the purpose it was designed for.
- Abuse or misuse of the equipment is **extremely dangerous** for people, pets and property. The manufacturer declines all responsibility for damage and injury resulting from **improper use and mishandling.**

- Certain basic safety rules must be observed when using electrical equipment, in particular: - Never touch the equipment with wet and/or damp hands or other parts of the body.
- Keep the equipment away from drops of water or sprinkling systems.
- Never use the equipment near high heat sources or explosive material.
- Do not introduce any extraneous matter into the equipment.
- Do not allow children or untrained people to use the equipment.
- Before cleaning or servicing the equipment outside, disconnect it from the supply and wait at least 2 seconds before working on it, as recommended by current safety regulations.
- In the event of faults and/or improper operation, turn off the equipment, shut off the electrical power and call your dealer.
- Do not attempt to make repairs and/or adjustments when covers/guards or circuit boards are to be removed.
- Blown fuses inside the power supply indicate that there may be a fault in the power supply itself. The fuses must be replaced by qualified and authorised persons. It is advisable to call your nearest dealer.
- Call your dealer for any repairs and be certain original spare parts are used.

Failure to observe this rule may adversely affect the safety level of your equipment.

- The equipment is to be connected to the mains supply and provided with adequate and efficient earth conductors.
- The electrical wiring must be done in compliance with current electrical codes CEI 64-8 "Electrical specification for domestic buildings".
- When installing, leave a clearance of at least 1 cm around the equipment to allow air to pass freely.

NOTE. This piece of equipment has been manufactured to the highest standards of workmanship. It must be used properly and serviced as recommended to ensure long-term dependable operation.

The installation must be done in order to be able to guarantee an easy access to the cable of feeding. The device of dissection of the equipment is the cable of feeding, so it must be unconnected from the equipment every time it is necessary to do any type of maintenance.



Mirage Digital Evolution

Contents	
Guarantee	2
Technical Support	2
Factory Service and Repairs	2
Shipping Instruction	2
Safety precautions.....	2
Contents.....	4
Section Section 1 Overview.....	6
1.1 Introduction	6
1.2 Programming and use.....	6
1.3 Flexible configuration.....	6
1.4 Programmability.....	6
1.5 Fully control of peak modulation.....	7
1.6 Positioning.....	7
1.7 First Turn On.....	7
1.8 Input & Output configurations.....	7
Section 2 Description	8
2.1 Front Panel	8
2.2 Rear Panel	8
2.2.1 PWS section.....	8
2.2.2 communication section.....	9
2.2.3 RDS/MPX section.....	9
2.2.4 digital audio section.....	9
2.2.5 analog audio section.....	9
Section 3 Audio IN/OUT.....	10
3.1 Cable connection.....	10
3.2 Analog IN/OUT.....	10
3.3 Digital AES/EBU input.....	10
3.4 Digital OPTICAL input.....	10
3.5 Digital OUTPUT.....	10
Section 4 Introduction Operations.....	10
4.1 Introduction to processing.....	10
4.2 Menù display.....	11
4.2.1 HOME.....	11
4.2.1 MENU.....	11
4.2.2 Analog Input.....	12
4.2.3 Digital AES Input.....	13
4.2.4 Digital Optical Input.....	14
4.2.5 Input Setup.....	15
4.2.6 Analog Output.....	16
4.2.7 Digital Output.....	17
Section 5 Process.....	18
5.1 Section 1st Preset	18
5.2 Section 2st Equalizer	19

Mirage Digital Evolution

5.3 Section 3st Bands	20
5.4 On Air Compare.....	22
Section 6 Stereo coder MPX.....	23
6.0.1 MPX Mode	23
6.0.2 Preenphasis.....	23
6.0.3 Pilot Level.....	23
6.0.4 External MPX	23
6.0.5 Composite Clipper.....	23
6.0.6 RDS/SCA external adjust	23
6.1 MPX Selection	24
6.1.1 MPX Internal	25
6.1.2 MPX External	26
Section 7 – Display	27
Section 8 - Version.....	28
Section 9 Appendix to audio process.....	28
9.1 Indications to audio process setting.....	29
9.2 table audio signal	31
Section 10 – Connections	32
10.1 Positioning	32
10.2 Inputs/Outputs.....	32
10.3 MPX Inputs/Outputs.....	33
10.4 XLR IN/OUT.....	33
Section 11 Block Diagram	34
Section 12 Technical data.....	35
12.1 General performance.....	35
12.2 Analog Audio Input.....	35
12.3 Digital Input	35
12.4 Analog Audio Output.....	35
12.5 Digital Output.....	36
12.6 Stereo generator.....	36
12.7 DATA	36
12.8 Logic I/O.....	36
12.9 GENERAL	36



1 - Overview

1.1 Introduction

The audio processor is a complete audio signal processing system for AM, FM and TV broadcasts. The multi-band structure is the best way to process an audio signal; In Mirage Dig Evolution, the audio process it is based on the four-band transformation of the audio signal. Each parameter configuration it is automatically checked for the audio effect. Finale can provide a feeling of general emphasis, greater power with continuity, presence and clarity, without "pumping" or other unnatural effects that would result in "audio" effects that have nothing to do with the original sound.

1.2 Programming and use

All processor settings and all operating sequences are clearly displayed on a high resolution TFT color display and are facilitated by a guided menu that shows the functions enabled for each programming step, navigation in the menu, each parameter setting, Activation and programming in general, is executed by means of the encode dial on the left of the TFT display. The resulting equalization and compression curves are displayed on the display, which Graphically reproduces the spectral distribution of the processed signal on the various bands.

1.3 Flexible configuration

The Mirage Dig Evolution audio processor is designed to meet all internationally-applicable security standards, and can also be configured for analog and / or digital emissions and inputs. Analog inputs are balanced high impedance active; The outputs are low-impedance and wide-band active to ensure better transparency and a precise pulse response. AES / EBU and optical digital inputs and outputs are available.

The digital I/O follows the AES/ EBU standard, and runs at 32, 44.1, 48 and 96 kHz.

All inputs, outputs, and electrical connections are strictly anti-shake in accordance with the traditional standards to ensure trouble-free installation.

1.4 Programmability

The Processor comes with 8 equalization curves resident in the program, 4 of which are not editable: FAST, VOICE, MEDIUM, LOW, and 4 other editable USER 1, USER 2, USER 3, USER 4, which help you understand Of the programming process. The user can edit a custom curve, name it and store it; All programming can be easily recalled directly by the operator from the list of stored curves; For specific programming, refer to the paragraph in question.

1.5 Full control of peak modulation

Processor audio processing circuits produce a signal that is pre-emphasized by 50 μ s or 75 μ s curves and is controlled in a precise and absolute way so as to avoid over-modulating phenomena; The signal is then filtered to protect the pilot tone at 19 KHz.

If the processor's output audio signal (Analog or Digital) is inserted into an external stereo encoder, it is advisable not to interpolate any other element between the two devices that could alter the bandwidth and create a modulation peak magnification Medium modulation. Otherwise you will have to reduce the modulation level to control the highest peaks. Frequency response errors and non-constant wavelength delay are typically introduced by equalizers, line transformers, low-pass filters at 15 kHz, and pre-emphasized networks in stereo encoders. It is therefore advisable, first of all, to "bypass" any low-pass and pre-emphasis filter circuits present in normal stereo encoders; We would like to point out that these features are already present within the processor. Low pass filters, high pass filters, transformers, distribution amplifiers, and long transmission lines can all cause an alteration of the signal with the above-mentioned consequences.

Obviously, the above-mentioned criteria for optimal control of peak modulation levels are met more easily when the audio processor directly powers the internal stereo encoder. In the Mirage Dig Evo, there are

no circuit elements between the audio processor and the internal stereo encoder that can cause waveform distortion. We therefore recommend using the Mirage with its built-in stereo encoder whenever it becomes feasible.

1.6 Positioning

The best position of the processor is as good as possible to the transmitter, so that the stereo encoder output can be connected to the transmitter over a short path, causing minimal variation in MPX signal waveform.

The processor outputs can drive a coder with a cable length of up to 3 m without any appreciable degradation of the MPX signal.

If this position is not possible, the best solution is to use digital audio signal transmission.

To ensure maximum transmission quality, all downstream equipment of the study must be carefully aligned and meet the appropriate standards for wavelength, distortion, traction wave lags and stability.

These devices must be re-checked at reasonable intervals.

It is therefore important that the audio source connected to the processor has low output noise, flat frequency response and low distortion

The buffered outputs of Mirage Dig Evo can drive a coder with a cable length of up to 10 m. Before any appreciable degradation of the MPX signal occurs.

1.7 First turn On

Before turning on the Mirage Dig Evo, make sure that the mains voltage is in accordance with the voltage range indicated on the rear of the power supply and that the electrical system to which the Processor is connected has a good grounding.

1.8 I/O audio configuration

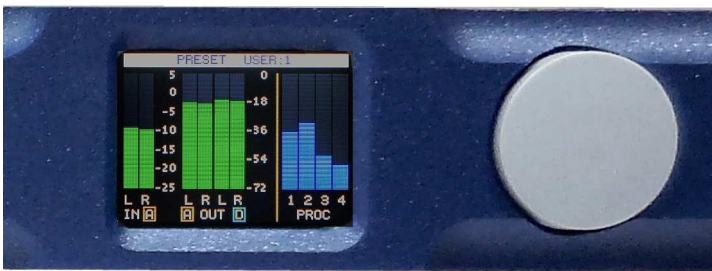
The processor can operate and manage simultaneously:

1. Input Audio Signal selection (Analog, AES/EBU, digital optical)
2. Balanced Analog output
3. Standard AES/EBU digital Audio output
4. Optical digital audio output
5. External MPX signal input / 19KHz synchronous output (**MPX version**)
6. composite MPX stereo output (**MPX version**)
7. RDS input - Radio Data System (**MPX version**)
8. SCA input (**MPX version**)



2 Description

2.1 Front panel

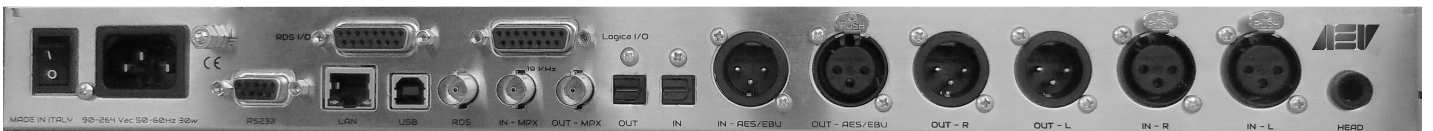


1

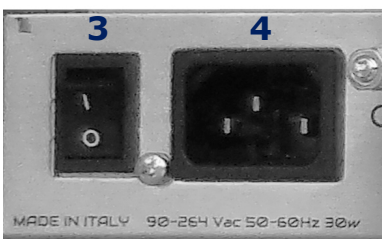
2

- 1: Display color TFT for monitoring & setup
- 2: Encoder jog

2.2 Rear panel

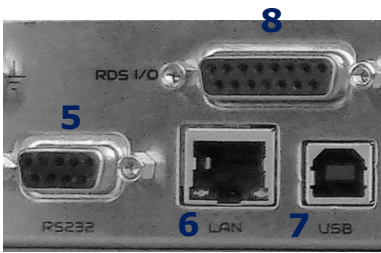


2.2.1 PWS section



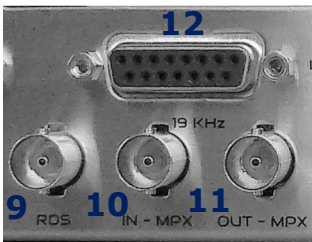
- 3: PWS switch ON/OFF
- 4: power socket VDE

2.2.2 communication section



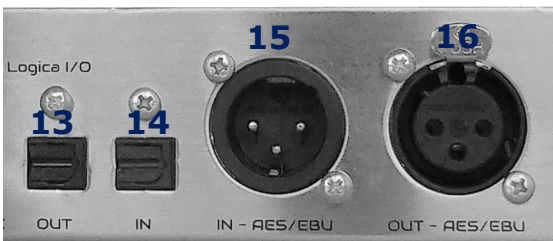
- **5:** serial RS232 connector
- **6:** ethernet connection RJ45
- **7:** USB-B connector
- **8:** RDS Logic I/O (only MPX version)

2.2.3 RDS/MPX section (only MPX version)



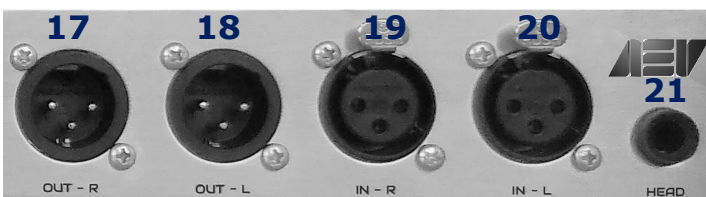
- **9:** RDS/SCA input connector BNC
- **10:** external MPX input connector BNC
- **11:** MPX composite output connector BNC
- **12:** processor Logic I/O (**all versions**)

2.2.4 digital audio section



- **13:** optical digital audio output
- **14:** optical digital audio input
- **15:** AES/EBU digital audio output
- **16:** AES/EBU digital audio input

2.2.5. analog audio section



- **17:** analog right output
- **18:** analog left output
- **19:** analog right input
- **20:** analog left input
- **21:** headphone output

3 AUDIO Input & Output

3.1 Connection cables

For input / output connections it is recommended to always use a good quality soft cable with good shielding.

It is also necessary to check the correct functioning of the earthing system and that in the audio connections between the GROUND and CHASSIS GROUND devices they are separated to avoid annoying buzzing.

3.2 Analog Input/Output

The analog XLR input are electronically balanced with input 10 K Ω impedance.

The male XLR analog outputs are active with 47 Ω impedance.

The output range varies from -12 dBm to +12 dBm with a 1 dB step.

The level control of the analog inputs and outputs is implemented via software on the ANALOG INPUT and ANALOG OUTPUT menus.

3.3 Digital Input AES/EBU

The AES / EBU digital input on female XLR can vary from -12 dBm to +12 dBm in 1 dB steps.

The input level control is implemented via software on the DIGITAL AES / EBU INPUT and DIGITAL OUTPUT menus.

3.4 Digital Optical Input

The optical digital input is connected to the dedicated fiber optic connector

The input signal range varies from -12 dBm to +12 dBm in 1 dB steps.

The input level control is implemented via software on the DIGITAL OPTICAL INPUT menus.

3.5 Digital Outputs

The AES/EBU digital output is supplied on a male XLR connector, the optical digital input is connected to the dedicated fiber optic connector.

The output range varies from -12 dBm to +12 dBm with a 1 dB step.

The level control of the digital outputs is implemented via software on the DIGITAL OUTPUT menus.

The selection of the sample rate of the digital signal is realized via software on the DIGITAL OUTPUT menus.

The value of the output level and of the digital signal network sample is unique for the AES/EBU signal and for the optical signal.

4 Operation

4.1 Introduction to processing

In any sound source it is possible to define the mean value and the peak value.

In the mean value it contains much of the power and is therefore the most significant part of the signal compared to the peak value that has contributions in terms of extremely low power.

Unfortunately, however, in the FM transmission, the maximum deviation of 75 KHz is determined by the peak value; So you are forced to work with a low level level producing a non-incisive sound level.

To increase the sound level, reduce the peak-to-medium ratio; If the peaks are reduced, the average level can be increased within the permissible modulation limits.

These operations can be achieved with signal limitation and expansion processes.

Mirage Dig Evo performs this processing on 4 different bands using adjustable threshold compression circuits.

Clipping is a more decisive control applied to that part of the signal that can not be compressed; This operation is always necessary to ensure maximum deviation of 75 KHz. Cutting does not produce audible side effects if it is carried out in moderation, in reverse, if it is used excessively, it may give rise to more or less annoying distortion.

A compression level that exceeds -16 dB (eg -18, - 20 etc.) continuously indicates a probable error setting of control parameters

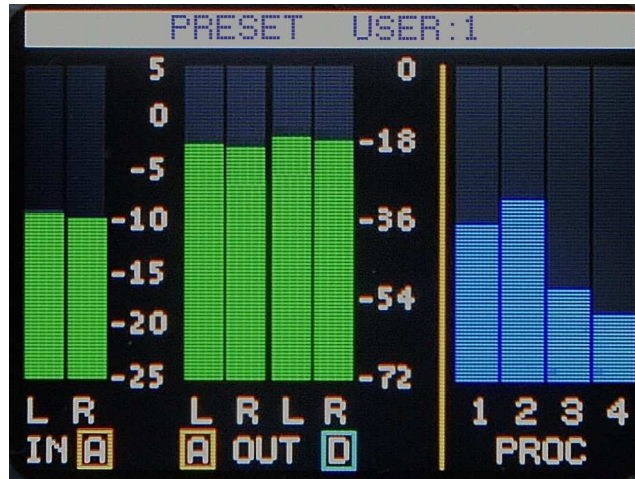
4.2 Menù display Mirage Dig Evo

Access to Mirage Dig Evo's menus is extremely facilitated thanks to the color TFT display on which all features are indicated.

Navigation is extremely simple and intuitive and is carried out using the encoder knob located to the left of the display.

4.2.1 HOME

While the processor is running, the HOME page is displayed on the display.



The following information is displayed on the HOME page:

- the selected Input audio signal level ("A" analog; "D" digital AES; "O" digital optical)
- Analog output signal level
- Digital output signal level (AES or Optical)
- indication of MAIN input
- display of the four dynamic process audio bands
- display of the four AGC dynamic bands
- Turning the knob directly without any pressure affects the output level of the headphone jack
- Pressing the Encoder Knob will display the MENU'

On the MENU page, at the top, next to PRESET is the name of the curve, the following are the pages of configuration of all the functions in the processor:



By rotating the Jog dial, you scroll the cursor over the various entries, to enter the selected page simply press the knob

4.2.2 Page ANALOG INPUT



- **LEV**, Adjusting the Analog Input Signal
- **BAL**, adjusting the analog input signal balance
- **ESC**, button to exit the mask and return to the general menu
- **SAVE**, a button that saves the changes made

LEVEL function:

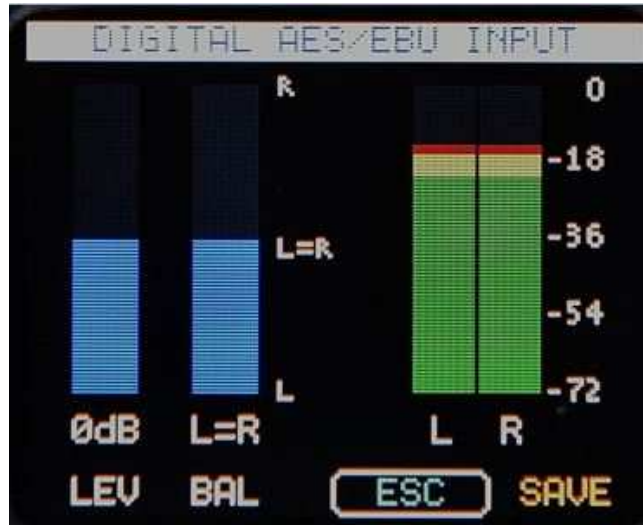
- Place the cursor on **LEV**
- A pressure on the knob enables the variation of the level of the analog input signal
- Turning the knob clockwise increases the signal level
- Turning the knob counter-clockwise decreases the signal level
- The value of signal variation is displayed graphically by means of a vertical bar and the corresponding value at the base of the bar, both vertically positioned above the **LEV** button

BALANCE function:

- Place the cursor on **BAL**
 - Pressing on the knob enables the balance of the stereo analog input signal balance
 - The center position of the bar (**L = R**) equals no change in the original balance of the input stereo signal
 - Turning the knob clockwise moves the balance toward the right channel (**R**)
 - turning the knob counterclockwise moves the balance to the left channel (**L**)
 - The value of the signal variation is displayed graphically by means of a vertical bar and the corresponding value in the box at the base of the bar, both placed above the **BAL** button
- To save the changes to the values in this form, position the cursor on the **SAVE** button and press the Jog knob once, at the knob pressure you save the changes and return to the MENU '

To exit the mask, position the cursor on the **ESC** button and press the jog knob to return to the MENU screen when the knob is pressed.

4.2.3 Page DIGITAL AES/EBU INPUT



In the DIGITAL AES / EBU INPUT page you can change the level and balance values of the audio signal at the AES / EBU digital input.

Rotating the encoder knob scrolls between the items on the bottom of the display:

- **LEV**, Adjusting the Analog Input Signal
- **BAL**, adjusting the analog input signal balance
- **ESC**, button to exit the mask and return to the general menu
- **SAVE**, a button that saves the changes made

LEVEL function:

- Place the cursor on **LEV**
- A pressure on the knob enables the variation of the level of the analog input signal
- Turning the knob clockwise increases the signal level
- Turning the knob counter-clockwise decreases the signal level
- The value of signal variation is displayed graphically by means of a vertical bar and the corresponding value at the base of the bar, both vertically positioned above the LEV button

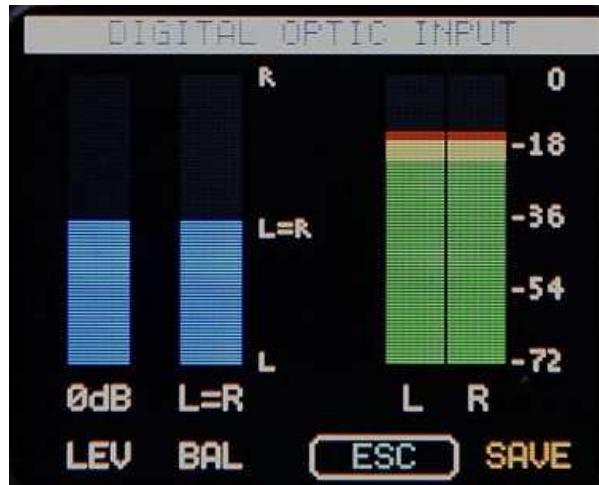
BALANCE function:

- Place the cursor on **BAL**
- Pressing on the knob enables the balance of the stereo analog input signal balance
- The center position of the bar (**L = R**) equals no change in the original balance of the input stereo signal
- Turning the knob clockwise moves the balance toward the right channel (**R**)
- turning the knob counterclockwise moves the balance to the left channel (**L**)
- The value of the signal variation is displayed graphically by means of a vertical bar and the corresponding value in the box at the base of the bar, both placed above the BAL button

To save the changes to the values in this form, position the cursor on the **SAVE** button and press the Jog knob once, at the knob pressure you save the changes and return to the MENU'

To exit the mask without saving the changes, position the cursor on the **ESC** button and press the Jog knob while pressing the knob returns to the MENU 'form.

4.2.4 Page DIGITAL OPTIC INPUT



On the DIGITAL OPTIC INPUT page you can change the level and balance values of the audio signal at the optical digital input.

Rotating the encoder knob scrolls between the items on the bottom of the display:

- **LEV**, Adjusting the Analog Input Signal
- **BAL**, adjusting the analog input signal balance
- **ESC**, button to exit the mask and return to the general menu
- **SAVE**, a button that saves the changes made

LEVEL function:

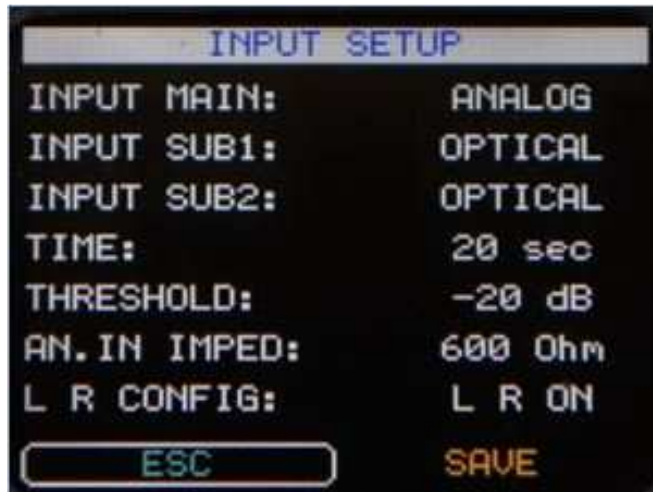
- Place the cursor on **LEV**
- A pressure on the knob enables the variation of the level of the analog input signal
- Turning the knob clockwise increases the signal level
- Turning the knob counter-clockwise decreases the signal level
- The value of signal variation is displayed graphically by means of a vertical bar and the corresponding value at the base of the bar, both vertically positioned above the **LEV** button

BALANCE function:

- Place the cursor on **BAL**
- Pressing on the knob enables the balance of the stereo analog input signal balance
- The center position of the bar (**L = R**) equals no change in the original balance of the input stereo signal
- Turning the knob clockwise moves the balance toward the right channel (**R**)
- turning the knob counterclockwise moves the balance to the left channel (**L**)
- The value of the signal variation is displayed graphically by means of a vertical bar and the corresponding value in the box at the base of the bar, both placed above the **BAL** button

To save the changes made to this mask, place the cursor on the **SAVE** button and then press the Jog knob once, the variations will be saved when you press the knob and return to the MENU screen.

4.2.5 Page INPUT SETUP



In this form you set some functions that determine the management of the input audio signal. The following items are sequentially:

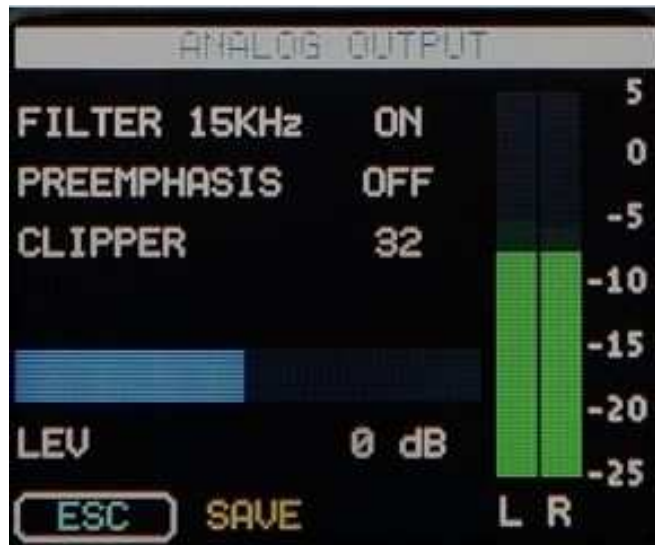
- **INPUT MAIN:** Selects the active input, named **MAIN**. Place the cursor on the box, the knob is pressed to select the input channel that will have the first priority of use between the three available inputs (ANALOG, DIGITAL AES/EBU and DIGITAL OPTICAL), the next knob pressure on the entry Chosen determines the storage of the choice made
- **ANALOG IMP.** Setting the impedance value of the analog input signal. Possible values are 600 Ohms or 10K Ohms. By placing the cursor on the box, you activate the value change with the knob pressure, after selecting the desired impedance value, the additional pressure sets the value indicated in the box.
- **INPUT MODE.** Setting the input signal mode. The possible selections are: **L R ON, L ON, R OFF, L OFF**.
- **L R ON:** The two input channels will have distinct paths and processes.
- **L OFF** only enables the signal on the right channel,
- **R OFF** only enables the signal on the left channel.

The two selections **L OFF** and **R OFF** are used to check the consistency of the Left and Right channels in case of link transfers or other transfer modes before the signal input in the transmitter. By placing the cursor on the box, you activate the mode change by pressing the knob, after selecting the desired mode, the additional pressure sets the value shown in the box.

To save the changes to the values in this form, position the cursor on the **SAVE** button and press the Jog knob once, at the knob pressure you save the changes and return to the MENU'

To exit the mask, position the cursor on the **ESC** button and press the jog knob to return to the MENU screen when the knob is pressed.

4.2.6 Page ANALOG OUTPUT



Using this mask, some important values and functions of the audio signal on the analog output are determined.

- **FILTER 15 KHz** command: enabling/disabling the 15 KHz filter, typical of the frequency modulation transmissions.
- **ON**: filter activation, the audio signal will be limited to the 20 Hz band up to 15 KHz;
- **50 us**: the preemphasis is set to 50 usec.
- **75 us**: the preemphasis is set to 75 usec.

• **OFF** filter deactivation, the audio signal is used throughout its spectral excursion, from 20 Hz to 20 kHz. In this mode, the Pre-Phase selection is disabled.

By positioning the cursor on the box, you activate the mode modification by pressing the knob, after selecting the desired mode (**ON / OFF**), the additional pressure sets the value indicated in the box.

• **PREEMPHASIS** command: enabling/disabling the preemphasis, typical of the frequency modulation transmissions. With FILTER 15 KHz in OFF setting Preemphasis is OFF also.

• **ON**: Pre-phase activation, the pre-phasing will be applied to the audio signal;

• **50 us**: the preemphasis is set to 50 usec.

• **75 us**: the preemphasis is set to 75 usec.

• **OFF** deactivation of the pre-phase, the audio signal will be deactivated.

By positioning the cursor on the box, you activate the mode modification by pressing the knob, after selecting the desired mode (**ON/OFF**), the additional pressure sets the value indicated in the box.

• **CLIPPER**: to adjust the value of Clipper, the range is from 0 to 40 (26 to manage the max deviation to 75 KHz).

• **LEV** adjusts the output signal level. It allows to adjust the output signal from -12 dB to + 12 dB,

A horizontal bar graphically displays the adjustment;

The numeric value in dB is displayed in the box below.

By placing the cursor on the box, the modification of the mode is activated by the knob

pressure, then, with the rotation of the knob, the adjustment is made, by rotating

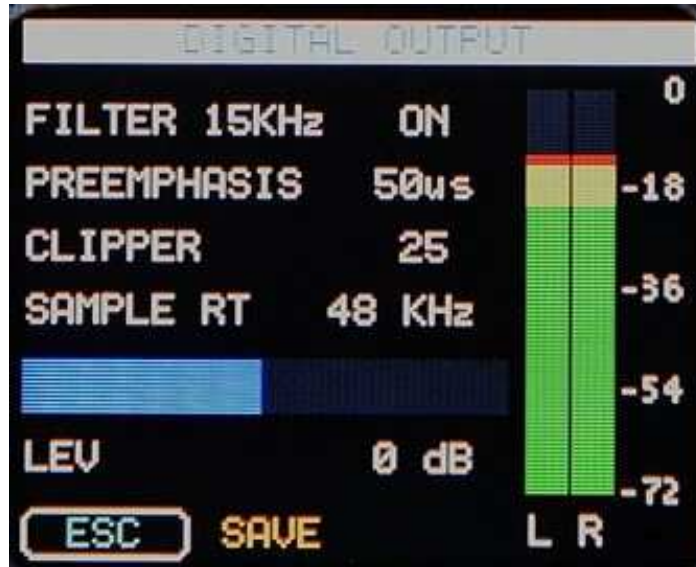
counterclockwise decreasing values are applied, clockwise, however, increasing values are

applied. The additional pressure sets the value indicated in the box; The next knob pressure

sets the adjustment to the displayed value. The two bars on the right side display the dynamic trend of the left and right output signal levels.

To save the changes to the values in this form, position the cursor on the **SAVE** button and press the Jog knob once, at the knob pressure you save the changes and return to the MENU ' To exit the mask, position the cursor on the **ESC** button and press the Jog knob while pressing the knob returns to the MENU '

4.2.7 Page DIGITAL OUTPUT



With this mask, some important values and functions of the audio signal are present on the digital outputs.

- **FILTER 15 KHz** Activating / deactivating the 15 KHz filter, typical of the frequency modulation transmissions.

ON: filter activation, the audio signal will be limited to the 20 Hz band up to 15 KHz;

OFF filter deactivation, the audio signal is used throughout its spectral excursion, from 20 Hz to 20 kHz.

By positioning the cursor on the box, you activate the mode modification by pressing the knob, after selecting the desired mode (ON / OFF), the additional pressure sets the value indicated in the box.

- **PREEMPHASIS** Activating / deactivating the pre-phase, typical of the frequency modulation transmissions;

With Filter 15 KHz in OFF, Pre-Phase Selection is disabled.

- **ON**: filter activation, the audio signal will be limited to the 20 Hz band up to 15 KHz;

- **50 us**: the preemphasis is set to 50 usec.

- **75 us**: the preemphasis is set to 75 usec.

- **OFF** filter deactivation, the audio signal is used throughout its spectral excursion, from 20 Hz to 20 kHz. In this mode, the Pre-Phase selection is disabled.

By positioning the cursor on the box, you activate the mode modification by pressing the knob, after selecting the desired mode (ON/OFF), the additional pressure sets the value indicated in the box.

- **OUTPUT**: This value is not editable and indicates the type of digital output that is active

If ANALOG is selected, the active digital output is AES / EBU

If AES / EBU is selected, the active digital output is AES / EBU

If input OPTIC is selected, the active digital output is OPTIC

- **CLIPPER**: to adjust the value of Clipper, the range is from 0 to 40 (26 to manage the max deviation to 75 KHz).

- **SAMPLE RATE** sets the sampling value of the digital signal.

Selectable values are 32, 48 and 96 KHz.

By placing the cursor on the box, a knob pressure activates the value change, after selecting the desired value (32, 48 and 96 KHz), the additional pressure sets the value shown in the box.

- **LEV** adjusts the output signal level. Allows you to adjust the output signal from -12 dB to + 12 dB, a horizontal bar graphically displays the setting; The numeric value in dB is displayed in the box below. By placing the cursor on the box, the modification of the mode is activated by the knob pressure, then, with the rotation of the knob, the adjustment is made, by rotating counterclockwise decreasing values are applied, clockwise, however, increasing values are applied , The additional pressure sets the value indicated in the box; The next knob pressure sets the adjustment to the displayed value.

The two bars on the right side display the dynamic trend of the left and right output signal levels.

To save the changes to the values in this form, position the cursor on the **SAVE** button and press the Jog knob once, at the knob pressure you save the changes and return to the MENU'

To exit the mask, position the cursor on the **ESC** button and press the Jog knob while pressing the knob returns to the MENU'

5 Page PROCESS

5.1 1th Section

In this section, all the audio process parameters are displayed to customize the configuration curve that is applied to the audio signal.

Sound quality defines the image and professionalism of the broadcaster, so it becomes apparent the importance of the AUDIO PROCESSOR.

Multiband Structure is the best way to process audio signal, Mirage Dig Evo is based on the process of audio signal in multiband mode.

Each curve has the ability to have full control of the process parameters so as to give your issuer a competitive sound with greater strength, continuity, presence and clarity without pumping or other unnatural effects.

In the form, next to the name of the page (PROCESS), the name of the curve running.



- **PRESET** : to display and set the ON AIR process
- **30 Hz** : to active the 30 Hz high pass filter
- **ENHANCER** : ON/OFF

Functions:

• **PRESET** displays the active curve and allows you to select and activate a curve between the stored curves. Positioning the cursor on the box activates the curve selection by pressing the knob, then rotating the knob, selecting the curve you want to recall, the further fixed pressure airs the curve shown in the box and, in the Below, recalls all parameters values of the selected curve

• **30 Hz FILTER**

Allows the 30 Hz filter to be switched on / off. Filter activation is recommended to avoid noise in the lower edge of the audio band.

By positioning the cursor on the box, you activate the mode modification by pressing the knob, after selecting the desired mode (ON / OFF), the additional pressure sets the value indicated in the box.

• **ENHANCER**

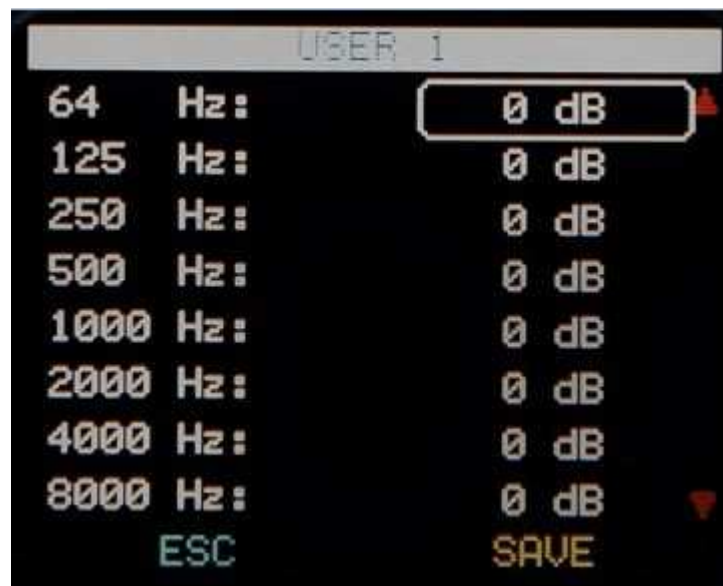
With Enhancer, you can increase the spatial image of the stereo sound. With active Enhacer function will increase the feeling of Loudness, with greater depth and spatiality of the sound, as well as a high dynamic of the sound itself. The Enhancer function allows a similar effect to a "wide" separation between left and right channels. This effect is achieved by adding a portion of the other to each channel, but in a reverse phase. By modifying this, the L-R and L + R ratio produces a more stereophonic sound, creating a very strong acoustic effect, especially on the audio details.

Includes activating / deactivating the ENHANCER function. By placing the cursor on the box, you activate the mode change by pressing the knob, after selecting the desired mode (ON / OFF), the further pressing sets the selection shown in the box.

To save the changes to the values in this form, position the cursor on the **SAVE** button and press the Jog knob once, at the knob pressure you save the changes and return to the MENU'

To exit the mask, position the cursor on the **ESC** button and press the Jog knob while pressing the knob returns to the MENU'

5.2 2th Section Equalization



To have a more refined interaction on the audio process you have an equalization section; Equalization is divided into eight bands, and their division is performed in octave multiples: 64 Hz, 128 Hz, 250 Hz, 500 Hz, 1000 Hz, 2000 Hz, 4000 Hz, and 8000 Hz for each frequency value. You can set the corresponding amplitude level. The assignable amplitude level can vary from -12 to +12 dB

To save the changes to the values in this form, position the cursor on the **SAVE** button and press the Jog knob once, at the knob pressure you save the changes and return to the MENU'

To exit the mask, position the cursor on the **ESC** button and press the Jog knob while pressing the knob returns to the MENU'

5.3 3th Section - BANDS

- **BAND** (1,2,3,4) selection of the band, between the four (BAND 1, BAND 2, BAND 3 and BAND 4) that characterize the processor's multiband band. By placing the cursor on the box, the band selection is activated by pressing the knob, then by rotating the knob, the selection of the band that you want to recall, the further pressure sets the values referring to the band indicated in the box and allows The selection of another band.



Each single band has some values that characterize it:

- **BAND** : display the referred bandwidth
- **GAIN** (X) gain level for the selected bandwidth (X = 1, 2, 3, 4), the assignable value may vary between -6 dB and + dB
- **ATTACK TIME**, compression attack time for the selected bandwidth
- **HOLD TIME**, Adjusts the time after which the RELEASE TIME intervenes for the selected bandwidth
- **RELEASE TIME**, Adjustment of the release time of the expansion for the selected bandwidth
- **THRESHOLD** Intervention threshold of the compressor (from -2dB to -40db) value for the selected band
- **TRANSITION**, Signal expansion ratio above the set threshold, the transition time to modify the process
- **DRIVE** Signal compression ratio above the set threshold, the compression level value for the selected band

The GAIN is the amplification for each single band before the compression control.

The amplification scale varies from -12 to +12 dB.

This control allows you to work MIRAGE DIG EVO as a dynamic expander; the concept can be explained by an example:

Suppose we work under these conditions:

LEVEL SINGLE BAND SIGNAL -10 dBm

GAIN 0 dB

THR LIMITER 0 dB

The input level is lower than the compression threshold so it is not limited but at the same time it has an amplitude of

- 10 dBm which determines a low output signal.

5.4 Page COMPARATE



ON AIR: Displays the process in transmission.

PRESET: Select the process to send in transmission.

COMPRESSOR. Process activated or bypassed

"**ESC**" to exit without store the modifications; the "**SAVE**" to save and store the modifications

On this page you can see the active output curve outbound, select an alternate curve, perform the comparison of the output audio effect between different processes, then decide which curve to make active

- **ON AIR** When the mask is opened, at the ON AIR line, the active wave curve will be displayed, positioning the cursor on this item and pressing the knob will activate the selection of available curves when you have selected the desired curve , Pressing the knob turns on the wave curve.

- **PRESET** Rotating the knob position the cursor in the PRESET item.

By positioning the cursor on this item, and by pressing the knob, you can select one of the available curves on the selected curve and select it as an alternative curve by pressing the knob. Select the process to send in transmission.

• **COMPRESSOR**

The ACTIVE state indicates that MIRAGE DIG EVO is enabled to process the signal, The BYPASS status indicates that the processor does not perform any control of the functions of the PROCESS section and then disables the compression part, the IN / OUT level controls remain active. P By positioning the knob on the COMPRESSOR item, pressing the dial activates the selection (ACTIVE / BYPASS), the desired value is activated by pressing the knob.

Once you have made any changes, position the cursor on ESC, pressing the knob will exit and you will see the MENU ' '

6 Section - Stereo coder MPX (only for the model MPX)



6.0.1 MODE: to select the STEREO/MONO mode This control enables the encoder modulator. Setting the STEREO function changes from MONO to STEREO mode. In the mono position, the 19 KHz sub-carrier is automatically deactivated.

6.0.2 PREEMPHASIS to select the preemphasis value, 50uS, 75uS or OFF

6.0.3 Pilot Level

This is the level control of the pilot signal that adjusts the width level

The MPX output signal. It can be set in the CODER menu.

The signal excursion can vary between 4 and 12% of the optimal level (-20 dB compared to 0 dBm of the MPX signal and is 10% of the signal producing \pm 75 KHz deviation).

6.0.4 MPX EXTERNAL: select **ON** to enable the the external MPX Input, **OFF** to enable the internal stereo coder MPX.

6.0.5 COMP CLIPPER: to adjust the clipper function on the MPX signal, value from 0 to 40.

6.0.6 RDS/SCA ADJ EXT: This control allows you to adjust the level of the external SCA / RDS signal input to the processor. The level can be adjusted from 0 dBm to + 12 dBm by operating in the CODER menu

6.1 MPX selection

In Mirage Dig Evo it is possible to select the source of the Stereo MPX signal: Internal and External. With Internal selection the audio it will be coded in Stereo MPX with the internal DSP digital coder, with External selection, the MPX signal present in INPUT MPX connector it will be drive to MPX output.

If it will be selected the **OFF** in the **MPX EXT** command, the page **MPX EXT** in the menu it will be disable and it will appear the message: **MPX SELECTED : INTERNAL**

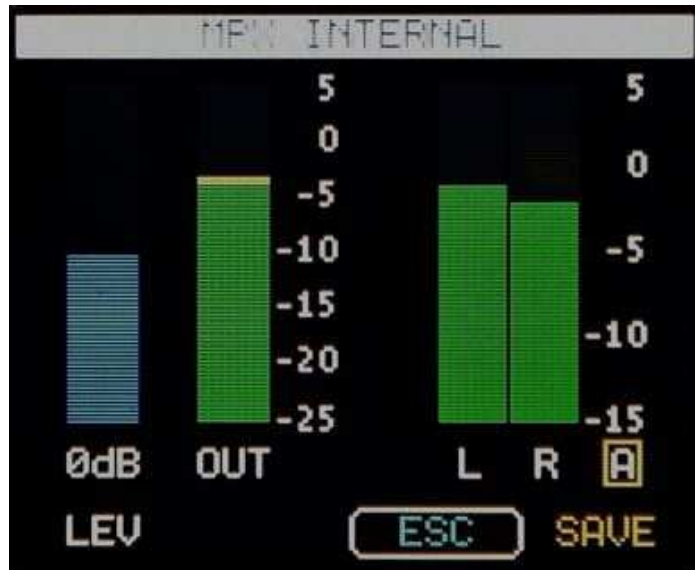


If it will be selected the **ON** in the **MPX EXT** command, the page **MPX INT** in the menu it will be disable and it will appear the message: **MPX SELECTED : EXTERNAL**



6.1.1 MPX INTERNAL

With **MPX EXT** command **OFF**, the page **MPX EXT** in the menu it will be disabled and it will appear the message: **MPX SELECTED : INTERNAL** and it will be available the page **MPX INTERNAL** :



On the **MPX INTERNAL** page you can change the level value of the MPX audio signal at the MPX Output connector.

Rotating the encoder knob scrolls between the items on the bottom of the display:

- **LEV**, Adjusting the MPX Output Signal and the OUT bar display the signal
- **L & R** bars display the audio signal that it drive to digital stereo coder MPX block
- **SAVE**, a button that saves the changes made

LEVEL function:

- Place the cursor on **LEV**
- A pressure on the knob enables the variation of the level of the MPX output signal
- Turning the knob clockwise increases the signal level
- Turning the knob counter-clockwise decreases the signal level
- The value of signal variation is displayed graphically by means of a vertical bar and the corresponding value at the base of the bar, both vertically positioned above the **LEV** button

The two bars on the right side display the dynamic trend of the left and right signal that it driven to stereo coder to generate the MPX output signal.

To save the changes to the values in this form, position the cursor on the **SAVE** button and press the Jog knob once, at the knob pressure you save the changes and return to the MENU'

To exit the mask, position the cursor on the **ESC** button and press the Jog knob while pressing the knob returns to the MENU'

6.1.2 MPX EXTERNAL

With **MPX EXT** command **ON**, the page **MPX INT** in the menu it will be disabled and it will appear the message: **MPX SELECTED : EXTERNAL** and it will be available the page **MPX EXTERNAL** :



On the **MPX EXTERNAL** page you can change the level value of the MPX audio signal at the MPX Output connector.

Rotating the encoder knob scrolls between the items on the bottom of the display:

- **LEV**, Adjusting the MPX Output Signal and the OUT bar display the signal
- **IN** bar display the external MPX signal that it drive to MPX Output
- **SAVE**, a button that saves the changes made

LEVEL function:

- Place the cursor on **LEV**
- A pressure on the knob enables the variation of the level of the MPX output signal
- Turning the knob clockwise increases the signal level
- Turning the knob counter-clockwise decreases the signal level
- The value of signal variation is displayed graphically by means of a vertical bar and the corresponding value at the base of the bar, both vertically positioned above the **LEV** button

The bar on the right side display the dynamic trend of the External MPX signal that it MPX output.

To save the changes to the values in this form, position the cursor on the **SAVE** button and press the Jog knob once, at the knob pressure you save the changes and return to the MENU'

To exit the mask, position the cursor on the **ESC** button and press the Jog knob while pressing the knob returns to the MENU'.

7.0 Page DISPLAY



On this page you will see, and you can change the following features:

- **BRIGHTNESS** displays the brightness of the display in%, positioning the cursor on this item, and pressing the knob switches the brightness of the display on. The minimum applicable value is such that the screen does not completely obscure; The maximum value (100%) applies the maximum brightness of the screen; The desired value is selected, it is activated by pressing the knob.
- **PROCESS DISPLAY**. This function allows you to choose how to display the audio process bars on the left side of the HOME form.
The selectable values are:
 - **BAND** by selecting this mode will display the overall trend of the four process bands.
 - **AGC** selecting this mode will display the compression of the AGC of each of the four process bands.
 - **ALTERN**, selecting this mode will alternately display the progress of the four process bars and the four AGC bars
- **TIME SWITCH** defines the rotation time between the four bars of the PROCESS and AGC display. This time is applied if alternate display is selected in the PROCESS DISPLAY item.

Once you have made any changes, position the cursor on ESC, pressing the knob will exit and you will see the MENU'.

8.0 VERSION – FwUPDATE

The following information is displayed in this form:



- HW Hardware version of the motherboard hardware
- Firmware Version, firmware version supplied with the processor
- DSP firm1 version software version of DSP
- DSP firm2 version, DSP version mounted on the motherboard

Pressing the k and the MENU 'mask is displayed.

9.0 Indications to Audio Process setting

9.1 Procedure to execute with a input signal including between -10 to 0 dB

ANALOG OUTPUT

(1) MENU 'INPUT SETUP UNLOCK:

(a) ANALOG.

(b) Disengage from the ANALOG OUTPUT menu to a 15Khz preemphasis and clipper filter

(2) ANALOG INPUT MENU:

(a) LEVEL SETTING to 0 dB.

(b) BALANCE: L = R.

(3) MENU' ANALOG OUTPUT

(a) FILTER 15Khz **OFF**.

(b) PREAMPHASIS **OFF**.

(c) CLIPPER **OFF**.

(d) LEVEL **0dB**.

(4) COMPARE MENU':

(a) Select a process

(5) AUDIO PROCESSOR MENU':

- a. 30Hz FILTER IN **ON**
- b. ENHANCER IN **OFF**
- c. Set all values of equalizer to **0Db**.
- d. Set all bands parameters with following value:

1 GAIN : 0 Db
2 ATTACK TIME: 10mS
3 HOLD TIME: 0%
4 RELEASE TIME: 10mS
5 THRESHOLD: -2Db
6 TRANSITION: 15
7 DRIVE : 1

You will get a gain of 0dB INPUT = OUTPUT.

Starting at 4.5 / 22Khz, adjust THRESHOLD A -30Db

Set the DRIVE to 10 and decrease the TRANSITION until reaching of the tone pleasing on the frequencies of the selected band (recommended 4).

Perform the same operations on the other 3 bands going down to the band 1 to make last.

Now the parameters ATTACK TIME, HOLD TIME and RELEASE TIME remain to be adjusted

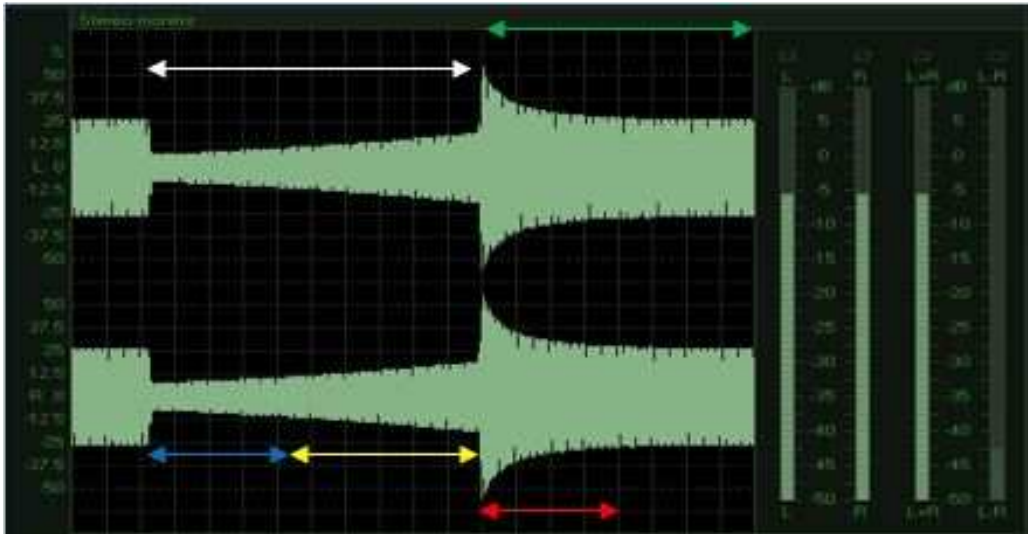
In order to obtain the result that is more in keeping with one's own transmission requirements, bearing in mind the graphs of figures 1 and 2.

Figure 1:

- 1. **ATTACK TIME set at 300mS**: It establishes the time that elapses before the intervention of the compression to the attack of the sound, in the case shown the initial peaks are allowed to pass, wider sound dynamics.
- 2. **RELEASE TIME set to 10mS**: It establishes the time that elapses before the intervention of the expansion, in the displayed case the expander intervention is very fast making the sound more abrupt.
- 3. **HOLD TIME: At 50%** of the RELEASE TIME, the intervention of the expansion is less abrupt.

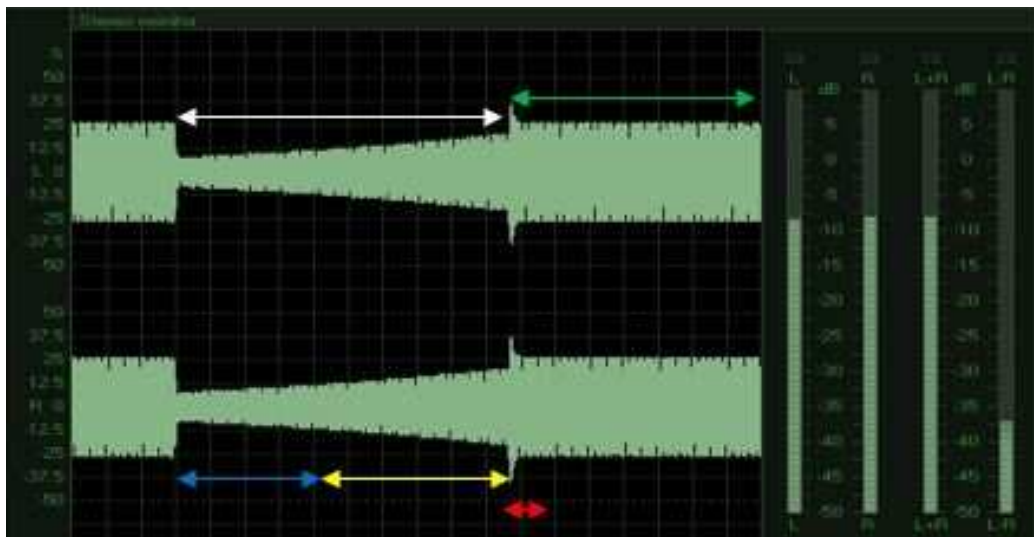


FIG. 1



1. **ATTACK TIME set at 10mS**: In the displayed case the initial peaks are compressed very quickly which tends to make the sound dynamics less extensive.
2. **RELEASE TIME set to 1000mS**: In the displayed case the expander's intervention being slow makes the sound more mellow.
3. **HOLD TIME**: At 50% of the RELEASE TIME Same operation as above.

Fig 2:



UTILIZZANDO IN MANIERA "SMART" DETTI COMANDI SI PUO' MODIFICARE IL SUONO A PROPRIO PIACIMENTO OTTENENDO LE TONALITA' PERSONALMENTE PIU' GRADITE.

9.2 Table with values related to the various types of instruments.

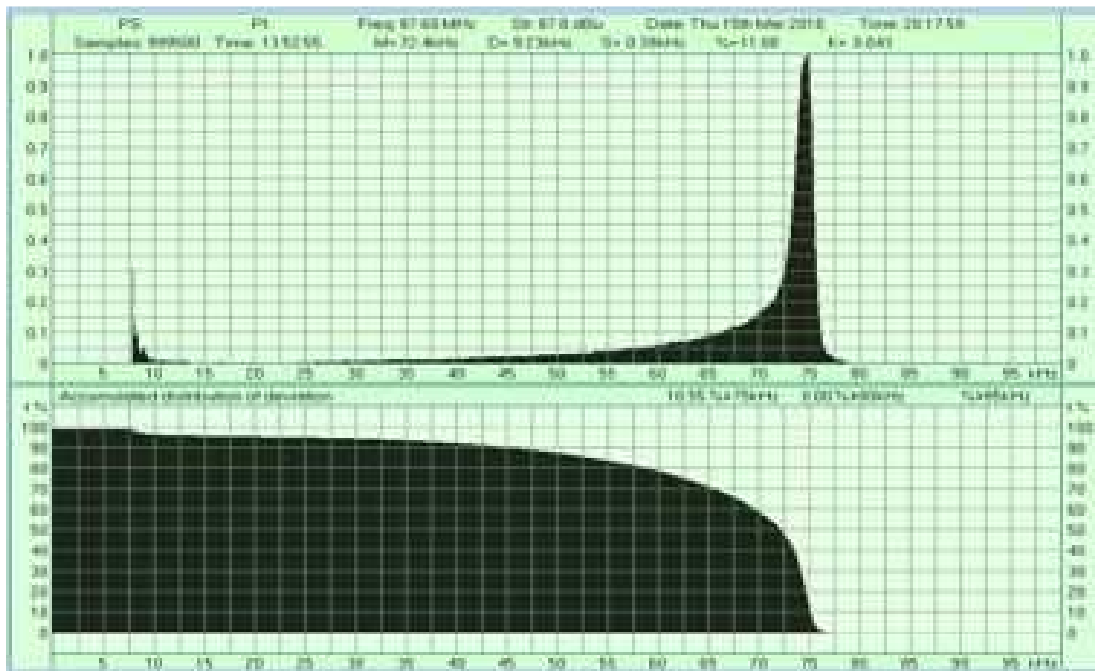
	ATTACK	RELEASE	TRANSITION	DRIVE
VOCAL(Voice)	25mS - 100mS	100mS - 500mS	15	2-4
cyclic bass (pasty bass)	25 mS 100mS - 500mS	25 mS 100mS - 500mS	1 - 4 1 - 5	12 - 15 10 - 15
RAGING ELECTRIC GUITAR	25mS	1000mS - 2000mS	1 - 2	15
ACOUSTIC GUITAR	100mS - 500mS	100mS - 500mS	2-4	5-8
BRASSY HORNS	25mS	25mS	1-2	12-15
DRUMS(rullan)	25mS	25mS	2-5	12-15
DRUMS(dishes)	25mS	1000 - 2000mS	2-10	10-15

Being clear that music is a set of sounds created by instruments with different tones and dynamics, one must try to reach the best compromise according to what will be processed.

An ATTACK TIME of 500mS and a RELEASE TIME of 2000ms will be fine for all the tools above.

Only the TRANSITION, the DRIVE and eventually the CLIPPER (see figure 3) will be left to adjust the transmission band within the + or - 75Khz according to the requirements.

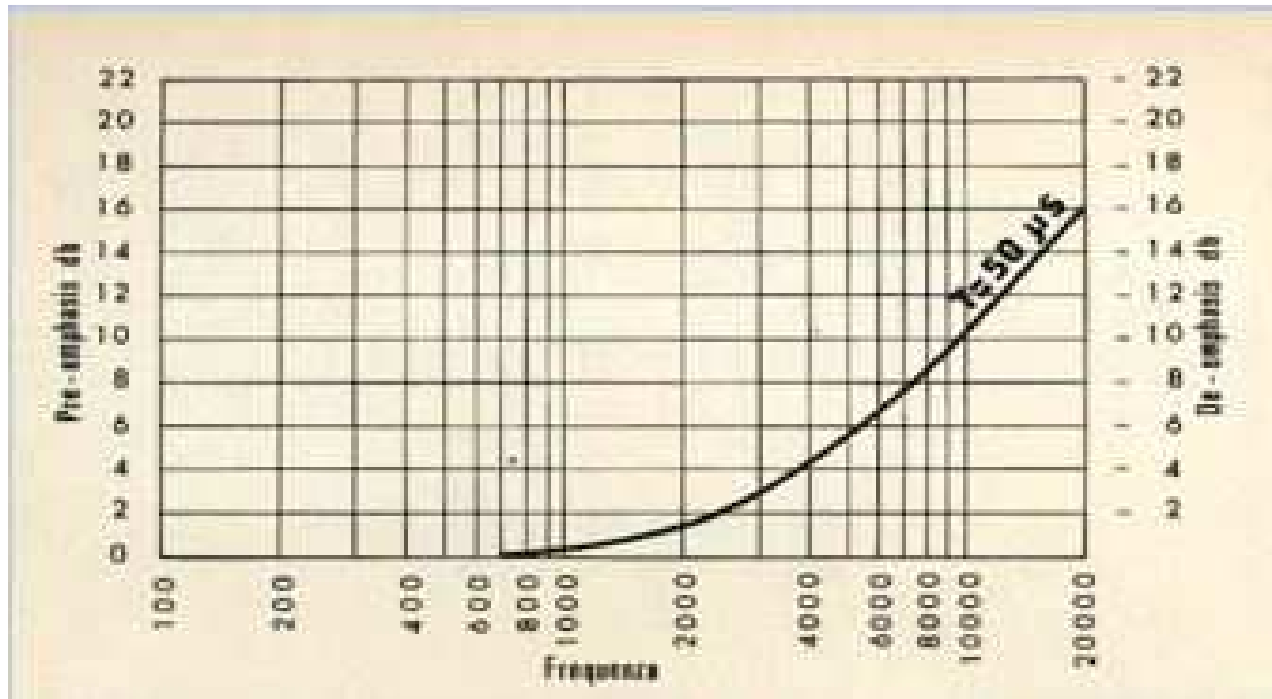
Fig 3



The process settings will remain valid for any type of selected input (Analog, AES/EBU or Optical). The settings of the CLIPPER PREEMPHASIS and the 15Khz FILTER insertion must be made in the respective menus, ANALOG OUTPUT, DIGITAL OUTPUT and STEREO CODER, according to the requirements.

The graph in Figure 3 shows the right way of adjusting the CLIPPER.

The graph in figure 4 shows the exaltation of the frequencies to the insertion of the 50uSec preemphasis, similar to the 75uSec trend.



Section 10 - Connections

It is recommended that the input and output connections are made with high quality and flexible cables, with good shielding.

Particular attention should be paid to the grounding of the machine and the quality of the power supply.

Earth connections. Earth connections and chassis between the units must be kept separate in order to avoid interference caused by mass loops.

10.1 Positioning

The audio processor circuits produce a signal that is pre-emphasized with 50 μ s or 75 μ s curves and precisely processed to avoid excessive modulation; the signal

Is then filtered to 15 KHz to protect the 19 kHz pilot tone, (10 KHz for the AM model)

If the processor's two-channel output signal is input to an external stereo encoder,

It is advisable not to introduce any other device that may alter the bandwidth and increase modulation peaks compared to the average value.

Frequency response errors and variable delays are typically introduced by equalizers, line transformers, low-pass filters 15 kHz and pre-emphasis networks in stereo encoders.

It is therefore appropriate, first of all, to bypass all low-pass filters and pre-emphasized circuits Present in normal stereo encoders.

Low-pass filters, high-pass filters, transformers, distribution amplifiers, and long transmission lines can alter the signal with the above-described consequences.

It is therefore clear that the criteria for the optimum peak modulation level above outlined,

Can be more easily satisfied if the audio processor directly powers an internal stereo encoder.

It is therefore strongly recommended that the processor be used with its own internal stereo encoder, wherever possible.

10.2 Inputs / Outputs

XLR inputs have selectable impedance between 600 Ω and 10k Ω .

The input signal range ranges from -20 dBm to +10 dBm.

The XLR outputs are electronically balanced with an impedance of 100 Ω .

The output range ranges from 0 dBm to +12 dBm.

Adjusting the input and output signal levels is done by going to the INPUT / OUTPUT menu.

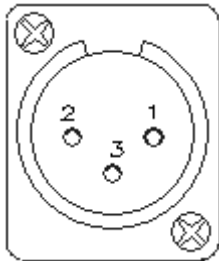
10.3 Input & output Encoder MPX (only MPX version)

The stereo encoder has an unbalanced output on a BNC connector located at the back panel. This output can drive an impedance of 50 or 75 KHz at a maximum distance of 10 meters via an RG 58 cable without visible degradation of the MPX signal.

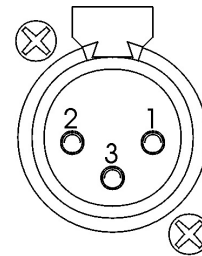
There is also an input that can accept SCA and RDS signals that can be adjusted by running in the CODER menu.

An output also provides synchronization of an external system: SYNC 19 KHz OUT 1 Vpp SW for external encoder synchronization.

10.4 Sample connection Analog & AES/EBU

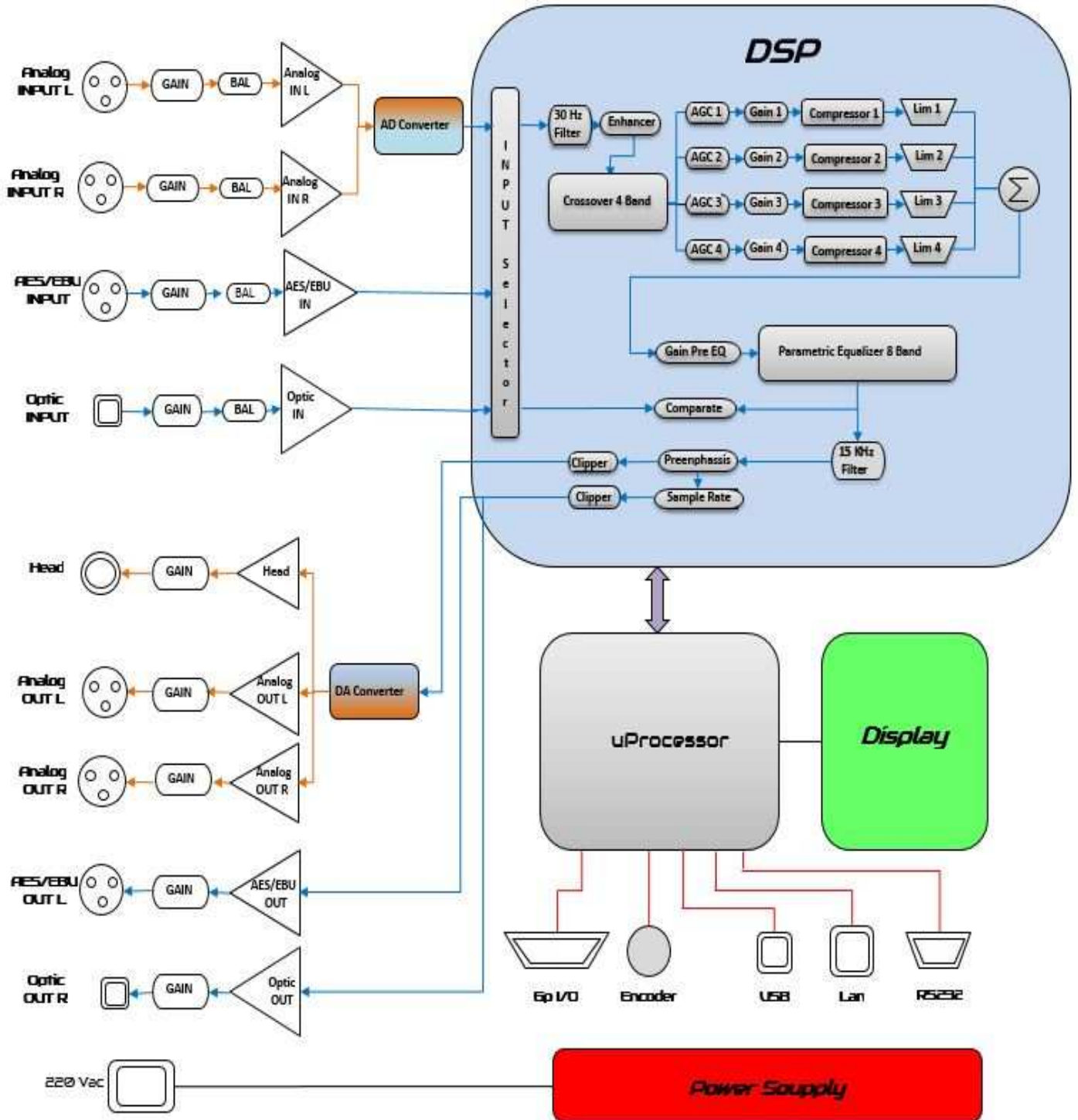


OUTPUT
1 = GROUND
2 = INPHASE
3 = RETURN



INPUT
1 = GROUND
2 = INPHASE
3 = RETURN

11 Section - Block Diagram



Section 12 - Technical Data

12.1 GENERAL PERFORMANCE

Frequency response	5Hz ÷ 15 KHz FM version 5Hz ÷ 9.5 KHz AM version
Stop band rejection	> 78 dB beyond 17 KHz
Noise	> 75 dB in all conditions (depends on the processing)
Total distortion	< 0,01 %
Total system separation	> 85 dB (30 Hz – 15 kHz)

12.2 ANALOG AUDIO INPUT

Configuration	Left and Right
Impedance	> 10 KΩ balanced
CMRR	> 45 dB from 30 to 15 KHz
A/D Conversion	64 kHz sample rate
Sensitivity	±12dBu
Maximum input level	+26 dBu
Connector	XLR-type, female, Pin 1 Chassis Pin 2 & 3 electronically balanced, floating and symmetrical

12.3 DIGITAL INPUT

Digital input configuration	AES 3 professional (IEC-60958)
Digital AES 3 Input Impedance	110 ohmBalanced
Digital AES 3 Input Connector	XLR Female
Sample Rate Automatic lock	32 - 44.1 - 48 - 96 KHz
Resolution	24 Bit
Over sampling	256 x

12.4 ANALOG AUDIO OUTPUT

Configuration	Left and Right. Flat or pre-emphasized (50μS – 75μS)
Impedance	30 Ohm electronically balanced and floating
Minimum load impedance	600 Ohm
Maximum output level	+24 dBu into 600 ohm load
Connector	XLR-type, male Pin 1 Chassis Pin 2 & 3 electronically balanced, floating and symmetrical

12.5 DIGITAL OUTPUT

Digital Output Sample Rate	Software Selectable 32 - 44.1 - 48 - 96 KHz
Resolution	24 Bit
Over sampling	256 x
Digital Output configuration	stereo AES 3 Transformer Balanced (IEC-60958)
Digital Output Impedance	110 Ohm Balanced
Digital Output Level	- 20.00 / 0 dBFS adjustable
Digital Output Connector	XLR Male

12.6 STEREO GENERATOR (version MPX only)

Configuration	one output
Pilot freq.	19 KHz \pm 0.001% Max over temp.
Pilot injection	+4 \div 12 %
Distortion	< 0.005 % @1 kHz
Noise signal ratio	70 dB (Din Audio,Bypass mode) Typical
Stereo separation	60 dB Typical
Crosstalk Main to Sub	Great 48 dB 30-15 kHz
Crosstalk Sub to Main	Great 46 dB 30-15 kHz
38 kHz subcarrier suppression	70 dB Typical
76 kHz suppression	70 dB Typical
Composite audio level	0 \div 12dB
Connector	BNC
Output impedance	50 ohm

12.7 DATA

Terminal Interface	Ethernet / RS232- at rear, asynchronous
Data Input	Full duplex
Format	Selectable
Serial Transmission Speed	2400 \div 19600 baud
Connector	RJ45 / RS232/ USB
Data management	Microprocessor controlled Non volatile memory RAM data retention 10 years

12.8 Logic I/O

Connector	DB15 cannon female
-----------	--------------------

12.9 GENERAL

Mains Voltage	100 – 260 Vac / 50 Hz full range
Dimension	(WxHxD) 48,3 x 19,4 x 4,4 cm 1 rack unit
Weight	3,5 Kg.
Operating Temp.	0 \div 50° C.
Operating Humidity.	Max 95% non condensing